

Research paper

Autoregulation of the human splice factor kinase CLK1 through exon skipping and intron retention

Simon Uzor, Panagiota Zorzou, Elizabeth Bowler, Sean Porazinski, Ian Wilson, Michael Ladamery[#]

Faculty of Health and Applied Sciences, University of the West of England, Coldharbour Lane, Frenchay, Bristol BS16 1QY, United Kingdom

[#]Corresponding author at: University of the West of England, Coldharbour Lane, Frenchay, Bristol BS16 1QY, United Kingdom. *E-mail address:* Michael.Ladamery@uwe.ac.uk

ABSTRACT

Alternative splicing is a key process required for the regulation of gene expression in normal development and physiology. It is regulated by splice factors whose activities are in turn regulated by splice factor kinases and phosphatases. The CDC-like protein kinases are a widespread family of splice factor kinases involved in normal physiology and in several diseases including cancer. In humans they include the *CLK1*, *CLK2*, *CLK3* and *CLK4* genes. The expression of *CLK1* is regulated through alternative splicing producing both full-length catalytically active and truncated catalytically inactive isoforms, CLK^{T1} (arising from exon 4 skipping) and CLK^{T2} (arising from intron 4 retention). We examined *CLK1* alternative splicing in a range of cancer cell lines, and report widespread and highly variable rates of exon 4 skipping and intron 4 retention. We also examined the effect of severe environmental stress including heat shock, osmotic shock, and exposure to the alkaloid drug harmine on *CLK1* alternative splicing in DU145 prostate cancer cells. All treatments rapidly eliminated exon 4

skipping and intron 4 retention, shifting the balance towards full-length CLK1 expression. We also found that the inhibition of CLK1 with the benzothiazole TG003 also eliminated exon 4 skipping and intron 4 retention suggesting an autoregulatory mechanism. CLK1 inhibition with TG003 also resulted in modified alternative splicing of five cancer-associated genes.

Keywords: CDC-like protein kinases, CLK1, alternative splicing, cassette exons, intron retention, detained introns, CLK1 inhibitor TG003, harmine.

1. Introduction

The CLK (CDC-2 like) protein kinases phosphorylate splice factors and contribute significantly to the regulation of alternative splicing. The *CLK1* gene was first identified in 1991 through a homology probing approach (Johnson and Smith, 1991). The full-length protein it encodes is 484 amino-acids long, of which the first 130 constitute a regulatory region required for the interaction of CLK1 with SR proteins (splice factors with a serine/arginine-rich domain). The remaining amino-acids form the catalytic domain containing the conserved signature EHLAMMERILG (Nayler et al., 1997; Menegay et al., 2000). There are four members of the *CLK* gene family in humans (*CLK1-4*); of these, *CLK1* and *CLK4* are most closely related. *CLK1*, *CLK2* and *CLK4* are ubiquitously expressed (Nayler et al., 1997), whereas *CLK3* expression is most prominent in spermatozoa (Menegay et al., 1999). The developmental and physiological function of the four members of the *CLK* family is beginning to emerge. CLK2 is involved in the control of diet-induced thermogenesis in brown adipose tissue (Hatting et al., 2017) and is a suppressor of hepatic gluconeogenesis (Rodgers et al., 2010). CLK1 is required for cell cycle progression (Dominguez et al., 2016), and CLK1, CLK2 and CLK4 help regulate the aurora B-dependent abscission checkpoint during mitosis (Petsalaki and Zachos, 2016). CLK kinases

phosphorylate the so-called 'SR protein' splice factors, facilitating their activation and release from nuclear speckles (Naro and Sette, 2013). However CLK kinases can also phosphorylate non-SR protein splice factors including the spliceosome-associated SPF45 (Liu et al., 2013). CLK activity is increasingly associated with the development and progression of cancer (Naro and Sette, 2013; Corkery et al., 2015; Czuby and Piekuelko-Witkowska, 2017). As a result there is considerable interest in developing selective CLK inhibitors that block tumour growth (Schmitt et al., 2014; ElHady et al., 2017; Murar et al., 2017; Sun et al., 2017; Riggs et al., 2017; Walter et al., 2017). CLK1 is also a potential target in the treatment of Alzheimer's (Jain et al., 2014) and has been earmarked for the treatment of Duchenne's muscular dystrophy as its inhibition causes the skipping of a mutated exon (Ogawa and Hagiwara, 2012; Sako et al., 2017). CLK targeting has also been proposed for the treatment of viral infection including HIV-1 (Wong et al., 2011) and influenza (Karlas et al., 2010; Zu et al., 2015).

The human *CLK1* gene is comprised of 13 exons, and is alternatively spliced expressing either a full length or truncated protein that lacks the catalytic domain (Duncan et al., 1997; Menegay et al., 2000). There are at least two alternative splicing mechanisms that result in the expression of truncated CLK1: skipping of exon 4 (Duncan et al., 1997) and intron retention, the latter reported in the mouse *Clk1* gene (Ninomiya et al., 2011). Most tissues express both full length and truncated CLK1, but their balance is altered following exposure to environmental stresses such as heat or osmotic shock (Menegay et al., 2000; Ninomiya et al., 2011; Corkery et al., 2015). There is a need to understand how *CLK1* expression, including its alternative splicing, changes and is regulated in normal development and disease. We examined the alternative splicing of human *CLK1* in a range of cancer cell lines, in response to environmental stress, and in response to CLK1 inhibition with TG003.

2. Materials and methods

2.1 Cell lines, cell culture and treatments

Prostate cancer cell lines (androgen independent PC3 and DU145, androgen dependent VCaP, and normal prostate epithelium PNT2) were cultured in Dulbecco's Modified Eagle's Medium (DMEM) containing 5mM glucose and L- glutamine, 10% fetal bovine serum (FBS), 100 U/ml streptomycin and 100µg/ml penicillin and 1% sodium pyruvate. Leukemic cell lines CMK (acute megakaryocytic leukemia); MOLT4 (acute lymphoblastic leukemia); RPKV8226 (myeloma); K562 (chronic myelogenous leukemia); HL60 (promyelocytic leukemia); and TK6 (hereditary spherocytosis) were cultured in RPMI medium with the same additives. All cell culture reagents were obtained from Sigma-Aldrich.

The alkaloid harmine and the CLK1 inhibitor benzothiazole TG003 were obtained from Sigma-Aldrich. TG003 stock solution was prepared in dimethylsulfoxide (DMSO) and harmine was dissolved in 50% ethanol. 1×10^6 DU145 PCa cells were treated with varying concentrations (10nM -100µM) of TG003 and 1-5µM harmine for 48 hours. For heat shock treatments, DU145 cells were incubated for one, three or six hours at 42°C in a tissue culture incubator (Orbital, S150 Stuart). Osmotic stress was induced by treatment with 200mM or 400mM sorbitol (Sigma-Aldrich) for three hours.

2.2 RNA extraction and cDNA synthesis

RNA extraction was performed using the RNA miniprep kit from Agilent Technology Ltd, USA as per manufacturer's instructions. RNA quality was verified on 1% (w/v) agarose gels and the concentration and purity was determined using Nanodrop (Spectrophotometric). cDNA

synthesis was performed using reverse transcriptase and a mixture of oligo (dT) and random primers as per manufacturer's instructions (Promega). 1µg RNA was mixed with 0.5µl of the oligo and 0.5µl random primers provided by the kit in a volume of 5.0µl with nuclease free water. The samples were placed in a heat block at 70°C for five minutes, then chilled on ice for five minutes. To each 5µl RNA sample, 15µl of reverse transcription reaction mix was added. Primers were allowed to anneal at 25°C for 5 min, cDNA synthesis proceeded at 42°C for one hour and finally the reverse transcriptase was inactivated at 70°C for 15 min.

2.3 Polymerase chain reaction

cDNA was amplified with the GoTaq kit (Promega) as per manufacturer's instructions using the *CLK1* primers (*E3F1* CAAGGATGTGAACCTGGACATCGC and *E4F1* GGAGGTACCTGATCTGTCAG forward primers in exons 3 and 4 respectively, and reverse primers *E5R1* CTCCTTCACCTAAAGTATCAAC and *E5R2* CTGCTACATGTCTACCTCCCGC in exon 5, as well as *β-actin* forward TTAAGGAGAAGCTGT and reverse GTTGAAGGTAGTTTCGTGGAT to verify cDNA synthesis; all sequences shown are 5'-3'). PCR cycles were as follows: 95°C for 2 minutes (initial denaturation), then 95°C for 1 min. (denaturation), 59°C for 1 min. (annealing), 72°C for 1.5 min. (extension); cycles were repeated 34 times followed by a final extension step at 72°C for 5 min.

2.4 Agarose gel electrophoresis

20µl aliquots of amplified PCR products were run in 2% (w/v) agarose gel at 95V and 400AMP for 1 hour. Agarose gels were stained in 0.2mg/ml ethidium bromide (Sigma-Aldrich). Gel images were obtained using UV transilluminator (Fisher Scientific).

2.5 Statistical analysis

All statistical tests were performed using GraphPad Prism 7.03. Mann-Whitney t-tests were used to compare significance between two groups. For multiple comparisons, one-way ANOVAs with Kruskal-Wallis test were performed. For all graphs, n.s. denotes not significant, * = $p \leq 0.05$, ** = $p \leq 0.01$, *** = $p \leq 0.001$.

3. Results

3.1 Features of *CLK1*'s exon 4 and intron 4

We began by examining the exon/intron structure of the human *CLK1* gene, focusing on exon 4 and surrounding intronic sequence (Fig. 1). The structure of the human *CLK1* gene mirrors closely that of the corresponding mouse gene, with a short intron separating exons 4 and 5 in both species and very high sequence conservation in exon 4 and flanking intron. Skipping of exon 4 has previously been reported in the human *CLK1* gene (Duncan et al., 1997), and both exon 4 skipping and intron 4 retention has been reported in the mouse gene (Ninomiya et al., 2011). Exon 4 skipping results in a premature stop codon interrupting the amino-terminal regulatory domain, resulting in a truncated 120 amino-acid previously named CLK1^T (Duncan et al., 1997). Intron 4 retention also creates a premature stop codon and a truncated CLK1, albeit a little longer (160 amino-acids). We propose to call the former CLK1^{T1} (arising from exon 4 skipping) and the latter CLK1^{T2} (due to intron 4 retention, Fig. 1A and 1B).

We analysed the exon 4 sequence on the RBPmap and SROOGLE servers (Paz et al., 2014; Schwart et al., 2009) and noted a number of interesting features (Fig. 1C). Firstly, there is a weak pyrimidine tract with three purines preceding exon 4 (...CUUGACGUUUCCAG, consensus Y₁₁NCAG, where Y is U or C). The 5' splice site at the end of exon 4 is also not especially strong, GATguauag compared to the consensus MAGguraqu where M is A or C and R is A or G. This

suggests that the baseline efficiency of exon 4 recognition and splicing is likely to be low. In contrast the end intron 4 possesses a better pyrimidine tract (...UUCUCUCUUUUAG). This suggests that more efficient exon 4 inclusion may require the action of specific splice factors acting through exonic splice enhancers (ESEs). Using the SROOGLE server (sroogle.tau.ac.il) we identified the presence of putative ESEs particularly at the beginning of exon 4 (Zhang and Chasin, 2004); these correspond to potential binding sites for splice factors SRSF1 and SRSF2, (Schwartz et al, 2008). Additional potential splice factor binding sites were identified using RBPmap (Paz et al., 2014), ESE finder (Cartegni et al., 2003) and SpliceAid (Piva et al., 2009). Exon 4 appears particularly dense with potential SRSF1 binding sites (Fig. 1C). Through SROOGLE we also noted the presence of a potential intronic splice silencer (ISS) immediately following the 5' splice site at the end of exon 4.

3.2 *Alternative splicing of CLK1 in of cancer cell lines*

Based on the reported skipping of exon 4 and retention of intron 4 in mouse embryo fibroblast-like NIH-3T3 cells (Ninomiya et al., 2011) we designed human-specific primers for RT-PCR including a forward primer in exon 3 and in exon 4 and two reverse primers in exon 5 that could be used to detect these alternative splicing events (Fig. 1A). Skipping of exon 4 had previously also been reported in the human embryonic kidney cell line 293T (Duncan et al., 1997). We surveyed a range of human cell lines to look for evidence of *CLK1* alternative splicing. We observed variable exon 4 skipping in all cell lines examined, and intron 4 retention in all but one cell line (Fig. 2). More specifically, alternative splicing of *CLK1* was observed in PC3 and DU145 androgen-independent prostate cancer cell lines, and in androgen-dependent VCaP cells. *CLK1* alternative splicing was also apparent in the normal prostate epithelium cell line PNT2, albeit with a higher degree of intron retention. We also observed alternative

splicing of *CLK1* in the cervical cancer cell line HeLa and in fetal kidney HEK293 cells (Fig. 2A). We also examined CLK1 alternative splicing in a range of leukemic cell lines (Fig. 2B). In the leukemic cell lines we observed widespread exon 4 skipping and intron 4 retention; however intron 4 retention was less prominent and was not detectable in MOLT4 acute lymphoblastic leukemia cells. In summary there is clear evidence that *CLK1* is alternatively spliced in all cancer cell lines examined, but the degree of exon 4 skipping or intron 4 retention varies significantly.

3.3 *Effect of heat shock, osmotic shock and harmine on CLK1 alternative splicing*

Heat shock and osmotic stress (the latter through exposure to high concentrations of sorbitol) were previously shown to promote the maturation of murine *Clk1* mRNA (Ninomiya et al. 2011). We sought to determine whether or not the human *CLK1* transcript is similarly affected. DU145 prostate cancer cells were grown at 42°C for one, three and six hours. After only one hour exon 4 skipping and intron 4 retention could not be detected (Fig. 3A). We confirmed that increased exon 4 inclusion and decreased intron 4 retention corresponded, as expected, to increased CLK1 protein levels (Fig. 3B). We exposed DU145 cells to osmotic stress in 200 and 400mM sorbitol. In these conditions we also observed a reduction in exon 4 skipping and loss of intron 4 retention (Fig. 3C). We also treated DU145 cells with the drug harmine, a multifunctional alkaloid derived from the plant *Peganum harmala* that has a range of effects including antimicrobial, antitumour, and hallucinogenic (Patel et al., 2010; Moloudizargari et al., 2013). Harmine is also a potent inhibitor of the splice factor DYRK1A (Göckler et al., 2009), and it causes changes in alternative splicing *in vivo* (Herrendorf et al., 2016). DU145 cells were treated with 1-5µM harmine for six hours. At the lowest concentration (1µM) harmine entirely eliminated both exon 4 skipping and intron 4 retention.

Thus we confirm that, like mouse *Clk1*, the human *CLK1* gene responds to heat shock and osmotic stress by promoting productive *CLK1* splicing (mRNA that encodes full length CLK1), and the same effect is observed following exposure to the alkaloid harmine.

3.4 Effect of TG003-mediated *CLK1* inhibition on alternative splicing

The benzothiazole compound TG003 was developed as a specific inhibitor of CLK1 (Muraki et al., 2004). TG003 has previously been shown to promote productive *CLK1* splicing in murine cells; we therefore sought to confirm this apparent autoregulatory effect in human cells. DU145 prostate cancer cells were treated with a wide range of TG003 concentrations, 10nM to 100µM. A clear shift in alternative splicing could be observed at 100nM (Fig. 4A). At the highest concentrations of TG003 no detectable exon 4 skipping or intron 4 retention was observed. We also examined CLK1 protein levels and observed that at the higher TG003 concentrations CLK1 protein levels clearly increased, consistent with the occurrence of more productive *CLK1* splicing (Fig. 4B).

The inhibition of CLK1 with TG003 has been shown to result in significant changes in global exon skipping rates (Sakuma et al., 2015). We examined the effect of TG003 on the alternative splicing of four apoptosis-related genes, *Bcl-X* (Boise et al., 1993), *Mcl-1* (Bae et al., 2000), *survivin* (Mahotka et al., 1999) and *CASP9* (Srinivasula et al., 1999) as well as the cancer-associated gene *FGFR10P* (FGFR10 oncogene partner; Lee et al., 2013). In all cases we observed clear changes in their alternative splicing, suggesting that the inhibition of CLK1 has a significant and widespread impact on alternative splicing of cancer-associated genes.

4. Discussion

The splice factor kinase CLK1, a member of the CDC2-like CLK family, contributes to the regulation of alternative splicing by phosphorylating SR proteins and other splice factors including the spliceosome-associated SPF45 (Liu et al., 2013). The *CLK1* gene is alternatively spliced (Duncan et al., 1997; Ninomiya et al., 2011), producing both catalytically active and truncated, inactive CLK1, the latter as a result of exon 4 skipping (120 amino-acids long CLK1^{T1}) or intron 4 retention (160 amino-acids long CLK1^{T2}). CLK1 is increasingly linked to the pathobiology of several diseases, including neurological conditions, metabolic disorders and cancer. We examined the baseline alternative splicing of *CLK1* in a range of human cancer cell lines, focusing on the skipping of exon 4 and retention of intron 4. We found evidence of widespread, and highly variable *CLK1* alternative splicing in 12 cell lines. Whereas significant rates of exon 4 skipping could be detected in leukemic cell lines, intron 4 retention was less prominent than in the prostate cancer cell lines. Both types of *CLK1* alternative splicing lead to the expression of truncated CLK1^{T1} (exon 4 skipping) and CLK1^{T2} (intron 4 retention), each lacking the catalytic domain. The presence of high levels of these CLK1 splice isoforms suggests that they are not entirely removed by nonsense-mediated decay (NMD). The ability of retained introns described as 'detained' introns to evade NMD has previously been reported (Boutz et al., 2015). Detained introns are a special class of introns that are poorly spliced and retained in the nucleus in order to modulate gene expression (Fu, 2017; Wegener and Müller-McNicoll, 2017). Interestingly, CLK1 itself has been shown to regulate the alternative splicing of nuclear 'detained' introns in hundreds of other genes (Boutz, Bhutkar & Sharp, 2015). We suggest that the co-expression of truncated, catalytically inactive CLK1 is functionally required to maintain an appropriate level of CLK1 activity. Interestingly, our results show that CLK1 inhibition with TG003 alters the balance of pro- and anti-apoptotic splice isoforms of *CASP9*, *MCL-1*, *BCL-X* and *survivin* genes, suggesting that the baseline

activity of CLK1 needs to be precisely maintained by cancer cells in order to prevent apoptosis. Future work will determine whether or not the effect of TG003 on the alternative splicing of these genes is directly attributable to CLK1 inhibition or due to an indirect effect.

We confirm that the alternative splicing of *CLK1* changes radically in response to severe environmental shock. We observe that heat shock, osmotic shock and harmine treatment all very rapidly lead to more efficient *CLK1* splicing, producing higher levels of catalytically active CLK1. Heat shock has been shown to lead to rapid dephosphorylation of the SR protein SRp38 (SRSF10) by protein phosphatase 1 (Shi and Manley, 2007). We note the presence of a putative SRSF10 binding site in exon 4 (Fig. 1C). We suggest that the equally rapid shift to productive CLK1 splicing in heat shock helps to augment the phosphorylation of SR proteins. The impact of harmine on the intron retention and exon skipping of *CLK1* pre-mRNA had not been previously assessed (Ogawa & Hagiwara, 2012). We show that exposure of DU145 cells to 1 μ M harmine for six hours also promoted the maturation of CLK1 pre-mRNA. Interestingly, CLK1 expression is also induced in hypoxic cells (Eisenreich et al., 2013; Jakubauskiene et al., 2015; Bowler et al., 2018). Activation of the *CLK1* promoter occurs through hypoxia inducible factor (HIF-1); however the effect of hypoxia on *CLK1* alternative splicing has not been examined. Taken together these findings indicate that cells need higher levels of catalytically active CLK1 to survive in conditions of extreme cellular stress.

We observed that inhibition of CLK1 with the benzothiazole TG003 also promoted productive *CLK1* splicing and at higher concentrations increased levels of CLK1 protein. There are several precedents of splice factors that autoregulate their expression through alternative splicing; these include Muscleblind-like 1 (MBNL1) (Gates et al., 2011), the FOX splice factors (Damianov and Black, 2010), and the SR proteins (Lareau and Brenner, 2015) including SRSF1

(Sun et al., 2010). Analysis of exon 4 and flanking intronic sequence suggests that exon 4 is not flanked by strong splice sites, and that several SR proteins, including SRSF1, SRSF2 and SRSF10, may bind and contribute to the regulation of exon 4 inclusion. SRSF1 was the first splice factor to be described as a proto-oncogene (Karni et al., 2007). SRSF1 is multifunctional, working at multiple levels of gene expression both in the nucleus and cytoplasm (Das and Krainer, 2014). In regulating alternative splicing, SRSF1 can both promote (Lopez-Mejia et al., 2013) and repress (Jumaa and Nielsen, 2000) the inclusion of cassette exons. SRSF1 is also a well characterized substrate of CLK1. CLK1's N-terminal domain contacts SRSF1; this interaction is required for hyperphosphorylation of SRSF1 by CLK1 and facilitates SRSF1 binding to RNA targets (Aubol et al., 2014). It is tempting to speculate that SRSF1 is involved in the autoregulation of *CLK1* alternative splicing. There is also a potential TIA-1 binding site around the 3' splice site; TIA-1 is involved in 3' splice site recognition (Huang et al., 2017). HnRNP H (Masuda et al., 2008) is often associated with splice silencers; there are also potential binding sites for this hnRNP protein in exon 4. Future research will determine precisely which splice factors are involved in *CLK1* autoregulation through alternative splicing.

We suggest that CLK1 activity in both transformed and normal cells is carefully regulated via *CLK1* alternative splicing through both exon 4 skipping and intron 4 retention. We suggest that CLK1 autoregulates its expression by favouring the expression of truncated isoforms, CLK1^{T1} and CLK^{T2} (Figure 5). Extreme environmental stress or CLK1 inhibition shifts the balance clearly towards productive splicing, increasing levels of full length CLK1. The function and regulation of expression of truncated splice isoforms CLK1^{T1} and CLK^{T2} remains to be fully determined. Novel therapies that target CLK1 will need to take into account the presence of truncated CLK1 isoforms and the autoregulatory loop.

Figure Legends

Fig. 1. Analysis of CLK1's alternatively spliced exon 4 and intron 4. (A) Schematic of CLK1 splice isoforms (exon 4 skipped and intron 4 retained). The position of the primers used for PCR is indicated. (B) Structure of CLK1 protein and its splice isoforms. CLK1 comprises an N-terminal domain which is retained in both splice isoforms. The full length protein includes a CDC-like protein kinase domain with an ATP binding cassette. (C) Analysis of human *CLK1* exon 4 and flanking intronic sequence. Putative splice factor binding sites are indicated. Data was obtained using RBPmap (rbpmap.technion.ac.il) and visualised on the UCSC genome browser. Exon 4 and surrounding intronic sequences are shown below; three putative exonic splice enhancers (green) and an intronic splice silencer (red) were identified *via* SROOGLE (Schwartz et al., 2008).

Fig. 2. Alternative splicing of *CLK1* in a range of cancer cell lines. Primers E3F1 and E5R2 were used to determine the extent of exon 4 skipping (E4S); primers E4F1 and E5R1 were used to measure intron 4 retention (I4R). The position of each splice isoform is indicated. (A) Expression in prostate cancer cell lines PC3, DU145 and VCaP, and for comparison normal prostate epithelium PNT2, HeLa (cervical cancer) and HEK293 (human embryonic kidney). (B) *CLK1* alternative splicing in leukemic cell lines: CMK (acute megakaryocytic leukemia); MOLT4 (acute lymphoblastic leukemia); RPKV8226 (myeloma); K562 (chronic myelogenous leukemia); HL60 (promyelocytic leukemia); and TK6 (hereditary spherocytosis). PSI values (rates of exon or intron inclusion) are shown on the right based on N=3 repeats.

Fig. 3. Effect of heat shock, osmotic shock and harmine treatment on *CLK1* alternative splicing. (A) DU145 prostate cancer cells were exposed to extreme heat shock (42°C) for 1, 3 and 6 hrs. PSI values (rates of exon or intron inclusion) are shown on the right based on N=3 repeats. (B) *CLK1* upregulation in heat shock confirmed at a protein level, quantified relative to GAPDH, N=3. (C) DU145 cells were exposed to 200mM and 400mM sorbitol for 3 hrs, or treated with 1-5 µM of the alkaloid harmine for 6 hrs.

Fig. 4. Effect of *CLK1* inhibition with the benzothiazole TG003 on *CLK1* alternative splicing. DU145 cells were treated for 48hrs with increasing doses of TG003. DMSO: dimethylsulfoxide solvent alone. (A) Effect on the expression of the splice isoforms at RNA level and (B) at a total protein level (β -actin loading control). PSI values (rates of exon or intron inclusion) are shown on the right based on N=3 repeats; upregulation of *CLK1* protein was confirmed relative to β -actin (N=3). Statistical comparisons are shown. (C) Effect of TG003 treatment on the alternative splicing of four apoptotic genes *Bcl-X*, *Mcl-1*, *survivin* and *caspase 9*, and on *FGFR10P* (*FGFR1* oncogene partner).

Fig. 5. Proposed model summarising the proposed autoregulation of *CLK1*. In normal physiological conditions, *CLK1* suppresses its own efficient splicing through skipping of exon 4 and retention of intron 4. In conditions of environmental stress, or if *CLK1* activity is inhibited, *CLK1* pre-mRNA is spliced more efficiently (productive splicing), increasing levels of *CLK1* protein.

Author contributions

ML supervised the research and wrote the manuscript with input from IW and SP. SU performed the experiments described in Figures 2 and 4, and PZ the experiments described in Figure 3.

Competing interests

The authors declare that they have no competing interests.

Ethics

The heading does not apply.

Acknowledgments

Simon Uzor was funded by the Tertiary Education Trust Fund, Government of Nigeria. Sean Porazinski was supported by a Research Innovation Award from Prostate Cancer UK, reference RIA-030-15. We are very grateful to Professor Masatoshi Hagiwara for advice on CLK1 inhibition *via* TG003.

References

- Aubol, B.E., Plocinik, R.M., Keshwani, M.M., McGlone, M.L., Hagopian, J.C., Ghosh, G., Fu, X.D., Adams, J.A., 2014. N-terminus of the protein kinase CLK1 induces SR protein hyperphosphorylation. *Biochem. J.* 462, 143-152.
- Bae, J., Leo, C.P., Hsu, S.Y. and Hsueh, A.J., 2000. MCL-1S, a splicing variant of the antiapoptotic BCL-2 family member MCL-1, encodes a proapoptotic protein possessing only the BH3 domain. *J. Biol. Chem.* 275, 25255-25261.
- Boise, L.H., González-García, M., Postema, C.E., Ding, L., Lindsten, T., Turka, L.A., Mao, X., Nuñez, G. and Thompson, C.B., 1993. Bcl-x, a bcl-2-related gene that functions as a dominant regulator of apoptotic cell death. *Cell* 74, 597-608.
- Boutz PL, Bhutkar A, Sharp PA, 2015. Detained introns are a novel, widespread class of post-transcriptionally spliced introns. *Genes & Dev.* 29, 63-80.
- Bowler, E., Porazinski, S., Uzor, S., Thibault, P., Durand, M., Lapointe, E., Rouschop, K.M.A., Hancock, J., Wilson, I., Ladomery, M., 2018/ Hypoxia leads to significant changes in alternative splicing and elevated expression of CLK splice factor kinases in PC3 prostate cancer cells. *BMC Cancer* 18, 355.
- Cartegni, L., Wang, J., Zhu, Z., Zhang, M.Q., Krainer, A.R., 2003. ESEfinder: a web resource to identify exonic splicing enhancers. *Nucleic Acids Res.* 31, 3568-3571.
- Corkery DP, Holly AC, Lahsaee S, Dellaire G., 2015. Connecting the speckles: Splicing kinases and their role in tumorigenesis and treatment response. *Nucleus* 6, 279-88.
- Czubaty, A., Piekietko-Witkowska, A, 2017. Protein kinases that phosphorylate splicing factors: Roles in cancer development, progression and possible therapeutic options. *Int. J. Biochem. Cell Biol.* 91, 102-115.

- Gates, D.P., Coonrod, L.A., Berglund, J.A., 2011. Autoregulated splicing of muscleblind-like 1 (MBNL1) pre-mRNA. *J. Biol. Chem.* 286, 34224-34233.
- Damianov, A., Black D.L., 2010. Autoregulation of Fox protein expression to produce dominant negative splicing factors. *RNA* 16, 405-416.
- Das, S., Krainer, A., 2014. Emerging functions of SRSF1, splicing factor and oncoprotein, in RNA metabolism and cancer. *Mol. Cancer Res.* 12, 1195-1204.
- Dominguez D, Tsai YH, Weatheritt R, Wang Y, Blencowe BJ, Wang Z., 2016. An extensive program of periodic alternative splicing linked to cell cycle progression. *Elife* 5, e10288.
- Duncan, P.I, Stojdl, D.F., Marius, R.M., Bell, J.C., 1997. In vivo regulation of alternative pre-mRNA splicing by the Clk1 protein kinase. *Mol. Cell. Biol.* 17, 5996-6001.
- Eisenreich A, Zakrzewicz A, Huber K, Thierbach H, Pepke W, Goldin-Lang P, Schultheiss HP, Pries A, Rauch U., 2013. Regulation of pro-angiogenic tissue factor expression in hypoxia-induced human lung cancer cells. *Oncol. Rep.* 30, 462-470.
- ElHady, A.K., Abdel-Halim, M., Abadi, A.H., Engel, M., 2017. Development of Selective Clk1 and -4 Inhibitors for Cellular Depletion of Cancer-Relevant Proteins. *J. Med. Chem.* 60, 5377-5391.
- Fu, X.D., 2017. Exploiting the hidden treasure of detained introns. *Cancer Cell.* 32, 393-395.
- Göckler, N., Jofre, G., Papadopoulos, C., Soppa, U., Tejedor, F.J., Becker, W., 2009. Harmine specifically inhibits protein kinase DYRK1A and interferes with neurite formation. *FEBS J.* 276, 6324-6337.

- Hatting, M., Rines, A.K., Luo, C., Tabata, M., Sharabi, K., Hall, J.A., Verdeguer, F., Trautwein, C., Puigserver, P., 2017. Adipose tissue CLK2 promotes energy expenditure during high-fat diet intermittent fasting. *Cell. Metab.* 25, 428-437.
- Herrendorf R., Faleschini M.T., Stiefvater A., Eme B., Wiktorowicz T., Kern F., Hamburger M., Potterat O., Kinter J., Sinnreich M., 2016. Identification of plant-derived alkaloids with therapeutic potential for myotonic dystrophy type I. *J. Biol. Chem.* 291, 17165-17177.
- Huang, S.C., Zhang, H.S., Yu, B., McMahon, E., Nguyen, D.T., Yu, F.H., Ou, A.C., Ou, J.P., Benz, E.J. Jr., 2017. Protein 4.1R exon 16 3' splice site activation requires coordination among TIA1, Pcbp1, and RBM39 during terminal erythropoiesis. *Mol. Cell. Biol.* 37, e00446-16.
- Jain P, Karthikeyan C, Moorthy NS, Waiker DK, Jain AK, Trivedi P, 2014. Human CDC2-like kinase 1 (CLK1): a novel target for Alzheimer's disease. *Curr Drug Targets.* 15, 539-550.
- Jakubauskiene, E., Vilys, L., Makino, Y., Poellinger, L., Kanopka, A., 2015. Increased Serine-Arginine (SR) protein phosphorylation changes pre-mRNA splicing in hypoxia. *J. Biol. Chem.* 290, 18079-18089
- Johnson K. W., Smith K.A., 1991. Molecular cloning of a novel human cdc2/CDC28-like protein kinase. *J. Biol. Chem.* 266, 3402-3407.
- Jumaa, H., Nielsen, P.J., 2000. Regulation of SRp20 exon 4 splicing. *Biochim. Biophys. Acta* 1494, 137-143.
- Karlas, A., Machuy, N., Shin, Y., Pleissner, K.P., Artarini, A., Heuer, D., Becker, D., Khalil, H., Ogilvie, L.A., Hess, S., Mäurer, A.P., Müller, E., Wolff, T., Rudel, T., Meyer, T.F., 2010. Genome-wide RNAi screen identifies human host factors crucial for influenza virus replication. *Nature* 468, 818-22.

- Karni R, de Stanchina E, Lowe SW, Sinha R, Mu D, Krainer AR., 2007. The gene encoding the splicing factor SF2/ASF is a proto-oncogene. *Nat. Struct. Mol. Biol.* 14, 185-193.
- Lareau, L.F., Brenner, S.E., 2015. Regulation of splicing factors by alternative splicing and NMD is conserved between kingdoms yet evolutionarily flexible. *Mol. Biol. Evol.* 32, 1072-1079.
- Lee, J.Y. and Stearns, T., 2013. FOP is a centriolar satellite protein involved in ciliogenesis. *PLoS One* 8, e58589.
- Liu, Y., Conaway, L., Rutherford Bethard, J., Al-Ayoubi, A.M., Thompson Bradley, A., Zheng, H., Weed, S.A., Eblen, S.T., 2013. Phosphorylation of the alternative mRNA splicing factor 45 (SPF45) by Clk1 regulates its splice site utilization, cell migration and invasion. *Nuc. Acids Res.* 41, 4949-4962.
- Lopez-Mejia, I.C., De Toledo, M., Della Seta, F., Fafet, P., Rebouissou, C., Deleuze, V., Blanchard, J.M., Jorgensen, C., Tazi, J., Vignais, M.L., 2013. Tissue-specific and SRSF1-dependent splicing of fibronectin, a matrix protein that controls host cell invasion. *Mol. Biol. Cell* 3164-3176.
- Mahotka, C., Liebmann, J., Wenzel, M., Suschek, C.V., Schmitt, M., Gabbert, H.E., Gerharz, C.D., 2002. Differential subcellular localization of functionally divergent survivin splice variants. *Cell death and differentiation* 9, 1334-1442.
- Masuda, A., Shen, X.M., Ito, M., Matsuura, T., Engel, A.G., Ohno, K., 2008. hnRNP H enhances skipping of a nonfunctional exon P3A in CHRNA1 and a mutation disrupting its binding causes congenital myasthenic syndrome. *Hum. Mol. Genet.* 17, 4022-4035.
- Menegay H, Moeslein F, Landreth G., 1999. The dual specificity protein kinase CLK3 is abundantly expressed in mature mouse spermatozoa. *Exp. Cell. Res.* 253, 463-73.

- Menegay H.J., Myers M.P., Moeslein F.M., Landreth, G.E., 2000. Biochemical characterization of the dual specificity kinase CLK1. *J. Cell Sci.* 113, 3241-3253.
- Moloudizargari, M., Mikaili, P., Aghajanshakeri, S., Asghari, M.H. and Shayegh, J., 2013. Pharmacological and therapeutic effects of *Peganum harmala* and its main alkaloids. *Pharmacognosy Reviews* 7, 199-212.
- Muraki, M. Ohkawara, B., Hosoya, T., Onog,i H., Koizumi, J., Koizumi, T., Sumi, K., Yomoda, J., Murray, M.V., Kimura, H., Furuichi, K., Shibuya, H., Krainer, A.R., Suzuki, M., Hagiwara, M., 2004. Manipulation of alternative splicing by a newly developed inhibitor of Clks. *J. Biol. Chem.* 279, 24246-24254.
- Murár, M; Dobiaš, J; Šramel, P; Addová, G; Hanquet, G; Boháč, A., 2017. Novel CLK1 inhibitors based on N-aryloxazol-2-amine skeleton - a possible way to dual VEGFR2 TK/CLK ligands. *Eur. J. Med. Chem.* 126, 754-761.
- Naro, C., Sette, C., 2013. Phosphorylation-mediated regulation of alternative splicing in cancer. *Int. J. Cell Biol.* 2013, 151839.
- Nayler, O., Stamm, S., Ullrich, A., 1997. Characterization and comparison of four serine- and arginine-rich (SR) protein kinases. *Biochem. J.* 326, 693-700.
- Ninomiya, K., Kataoka, N., Hagiwara, M., 2011. Stress-responsive maturation of Clk1/4 pre-mRNAs promotes phosphorylation of SR splicing factor. *J. Cell Biol.* 195, 27-40.
- Ogawa, Y., Hagiwara, M., 2012. Challenges to congenital genetic disorders with "RNA-targeting" chemical compounds. *Pharmacol. Ther.* 134, 298-305.
- Patel K., Gadewar M., Tripathi R., Prasad S.K., Patel D.K., 2012. A review on medicinal importance, pharmacological activity and bioanalytical aspects of beta-carboline alkaloid 'harmine'. *Asian Pac. J. Trop. Biomed.* 2, 660-664.

- Paz I., Kosti I., Ares M. Jr, Cline M., Mandel-Gutfreund Y., 2014. RBPmap: a web server for mapping binding sites of RNA-binding proteins. *Nuc. Acids Res.* 42, W361-W367.
- Petsalaki, E., Zachos, G., 2016. Clks 1, 2 and 4 prevent chromatin breakage by regulating the Aurora B-dependent abscission checkpoint. *Nat. Commun.* 7, 11451.
- Piva, F., Giulietti, M., Nocchi, L., Principato, G., 2009. SpliceAid: a database of experimental RNA target motifs bound by splicing proteins in humans. *Bioinformatics* 25, 1211-1213.
- Riggs, J.R., Nagy, M., Elsner, J., Erdman, P., Cashion, D., Robinson, D., Harris, R., Huang, D., Tehrani, L., Deyanat-Yazdi, G., Narla, R.K., Peng, X., Tran, T., Barnes, L., Miller, T., Katz, J., Tang, Y., Chen, M., Moghaddam, M.F., Bahmanyar, S., Pagarigan, B., Delker, S., LeBrun, L., Chamberlain, P.P., Calabrese, A., Canan, S.S., Leftheris, K., Zhu, D., Boylan, J.F., 2017. The discovery of a dual TTK protein kinase/CDC2-Like Kinase (CLK2) inhibitor for the treatment of triple negative breast cancer initiated from a phenotypic screen. *J. Med. Chem.* 60, 8989-9002.
- Rodgers, J.T., Haas, W., Gygi, S.P., Puigserver, P., 2010. Cdc2-like kinase 2 is an insulin-regulated suppressor of hepatic gluconeogenesis. *Cell Metab.* 11, 23-34.
- Sako, Y., Ninomiya, K., Okuno, Y., Toyomoto, M., Nishida, A., Koike, Y., Ohe, K., Kii, I., Yoshida, S., Hashimoto, N., Hosoya, T., Matsuo, M., Hagiwara, M., 2017. Development of an orally available inhibitor of CLK1 for skipping a mutated dystrophin exon in Duchenne muscular dystrophy. *Sci. Rep.* 7:46126.
- Sakuma, M., Iida K., Hagiwara M., 2015. Deciphering targeting rules of splicing modulator compounds: case of TG003. *BMC Mol. Biol.* 16, 16-29.

- Schmitt, C., Miralinaghi, P., Mariano, M., Hartmann, R.W., Engel, M., 2014. Hydroxybenzothiophene Ketones Are Efficient Pre-mRNA Splicing Modulators Due to Dual Inhibition of Dyrk1A and Clk1/4. *ACS Med. Chem. Lett.* 5, 963-967.
- Schwartz, S., Hall, E., Ast, G., 2009. SROOGLE: webserver for integrative, user-friendly visualization of splicing signals. *Nuc. Acids Res.* 37, W189-W192.
- Schwartz, S.H., Silva, J., Burstein, D., Pupko, T., Eyra, E., Ast, G., 2008. Large-scale comparative analysis of splicing signals and their corresponding splicing factors in eukaryotes. *Genome Res.* 18, 88-103.
- Shi Y., Manley J. L., 2007. A complex signaling pathway regulates SRp38 phosphorylation and pre-mRNA splicing in response to heat shock. *Mol. Cell* 28, 79–90.
- Srinivasula, S.M., Ahmad, M., Guo, Y., Zhan, Y., Lazebnik, Y., Fernandes-Alnemri, T. and Alnemri, E.S., 1999. Identification of an endogenous dominant-negative short isoform of caspase-9 that can regulate apoptosis. *Cancer Res.* 59, 999-1002.
- Sun, Q.Z., Lin, G.F., Li, L.L., Jin, X.T., Huang, L.Y., Zhang, G., Yang, W., Chen, K., Xiang, R., Chen, C., Wei, Y.Q., Lu, G.W., Yang, S.Y., 2017. Discovery of potent and selective inhibitors of Cdc2-Like Kinase 1 (CLK1) as a new class of autophagy inducers. *J. Med. Chem.* 60, 6337-6352.
- Sun, S., Zhang, Z., Sinha, R., Karni, R., Krainer, A.R., 2010. SF2/ASF autoregulation involves multiple layers of post-transcriptional and translational control. *Nat. Struct. Mol. Biol.* 17, 306–312.
- Walter A, Chaikuad A, Loäc N, Preu L, Knapp S, Meijer L, Kunick C, Koch O., 2017. Identification of CLK1 Inhibitors by a Fragment-linking Based Virtual Screening. *Mol. Inform.* 36(4).

- Wegener, M., Müller-McNicoll, M., 2017. Nuclear retention of mRNAs - quality control, gene regulation and human disease. *Semin, Cell. Dev. Biol.* S1084-9521, 30442-1.
- Wong, R., Balachandran, A., Mao, A.Y., Dobson, W., Gray-Owen, S., Cochrane, A., 2011. Differential effect of CLK SR Kinases on HIV-1 gene expression: potential novel targets for therapy. *Retrovirology.* 8:47.
- Zhang, X.H., Chasin, L.A., 2004. Computational definition of sequence motifs governing constitutive exon splicing. *Genes Dev.* 18, 1241-1250.
- Zu, M., Li, C., Fang, J.S., Lian, W.W., Liu, A.L., Zheng, L.S., Du, G.H., 2015. Drug discovery of host CLK1 inhibitors for influenza treatment. *Molecules* 20, 19735-19747.

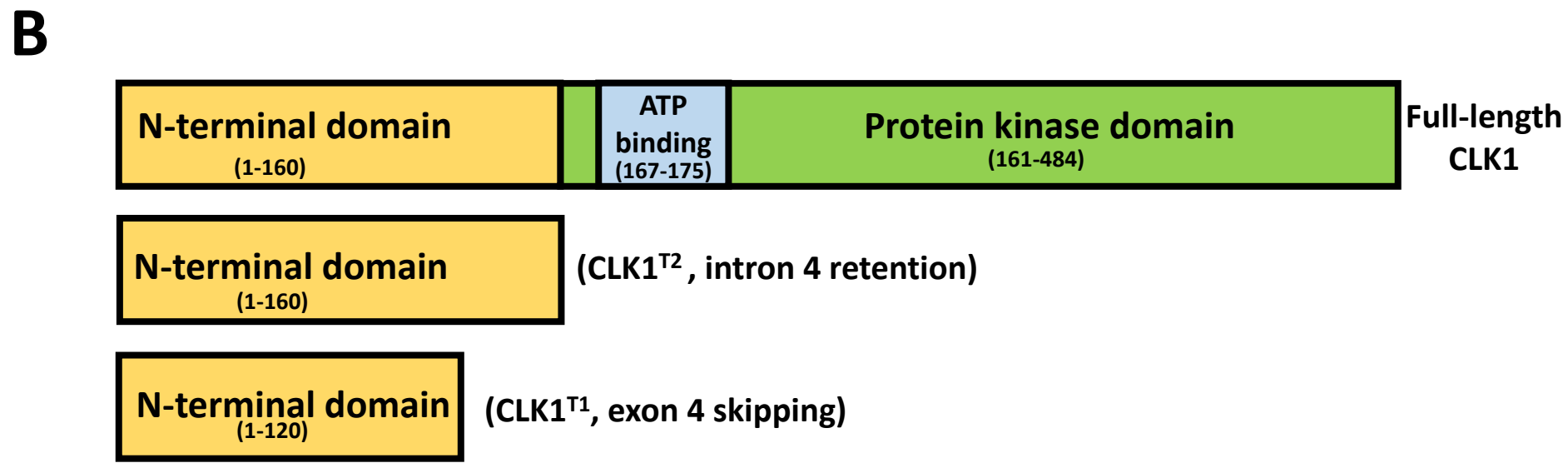
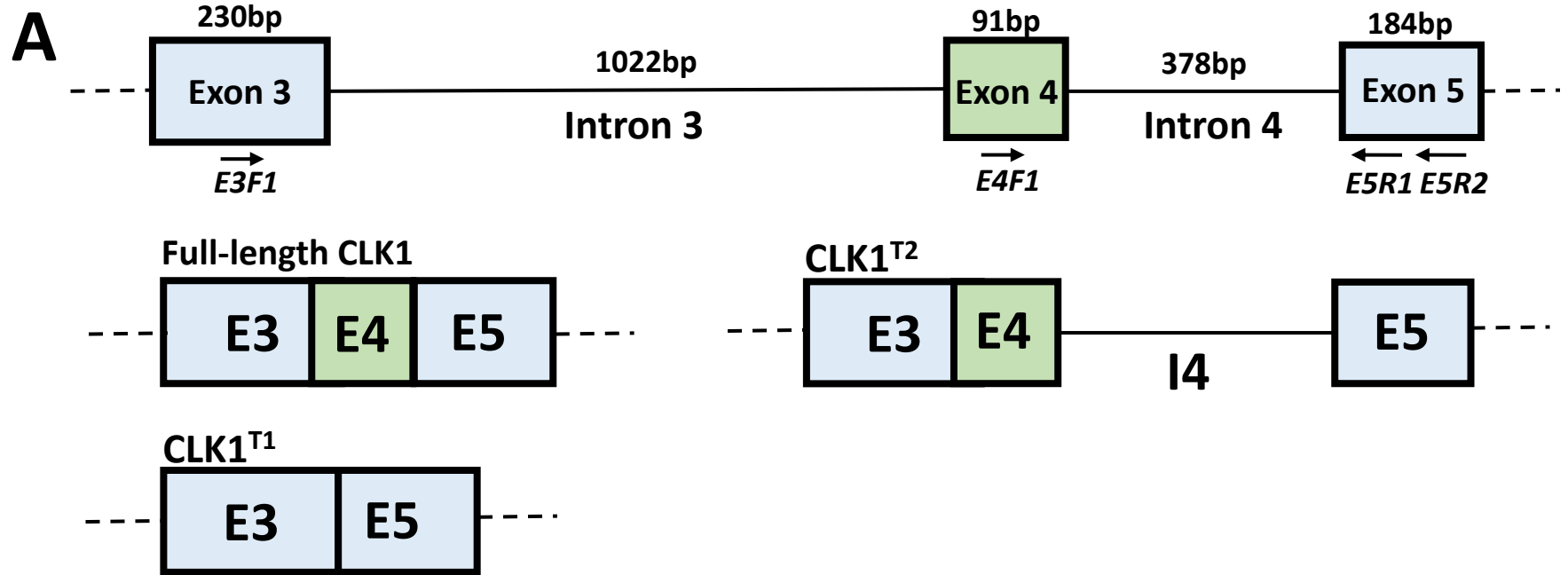
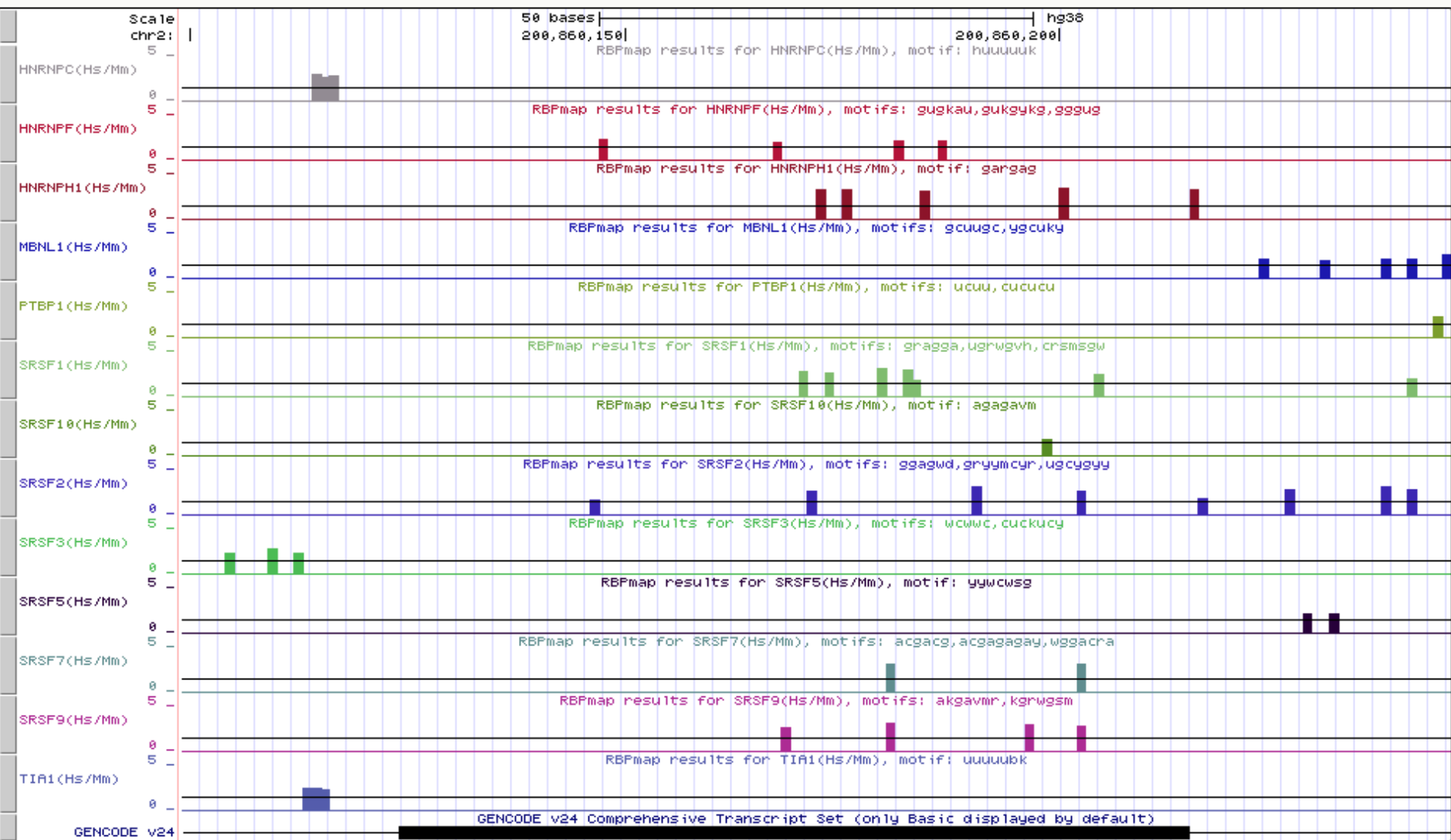
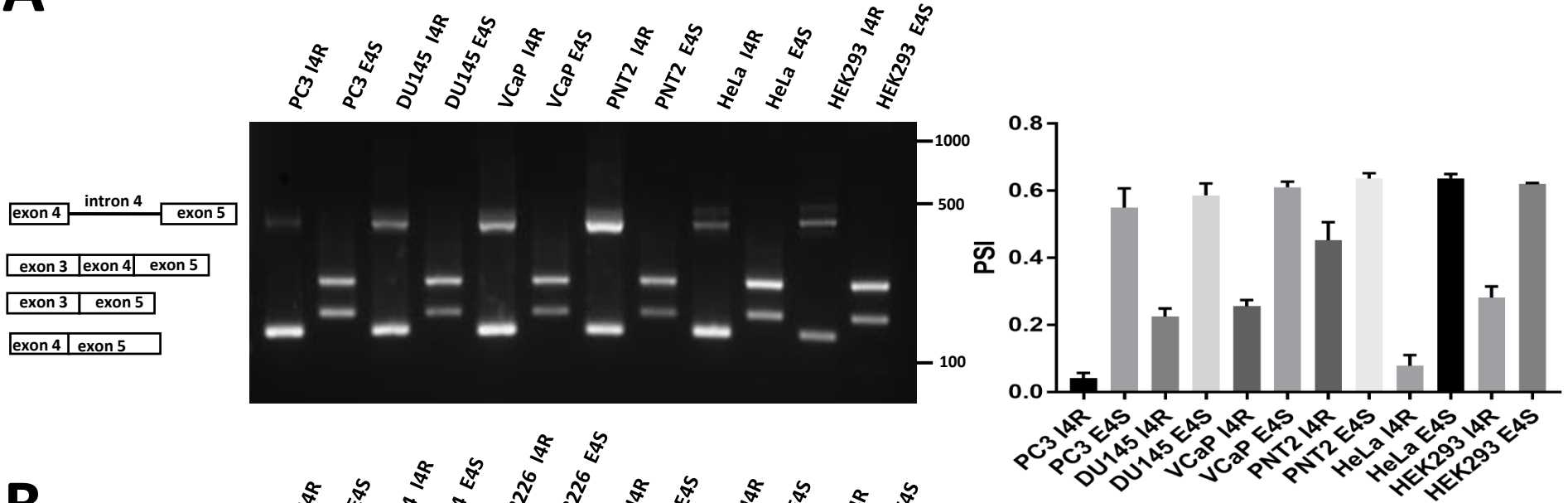
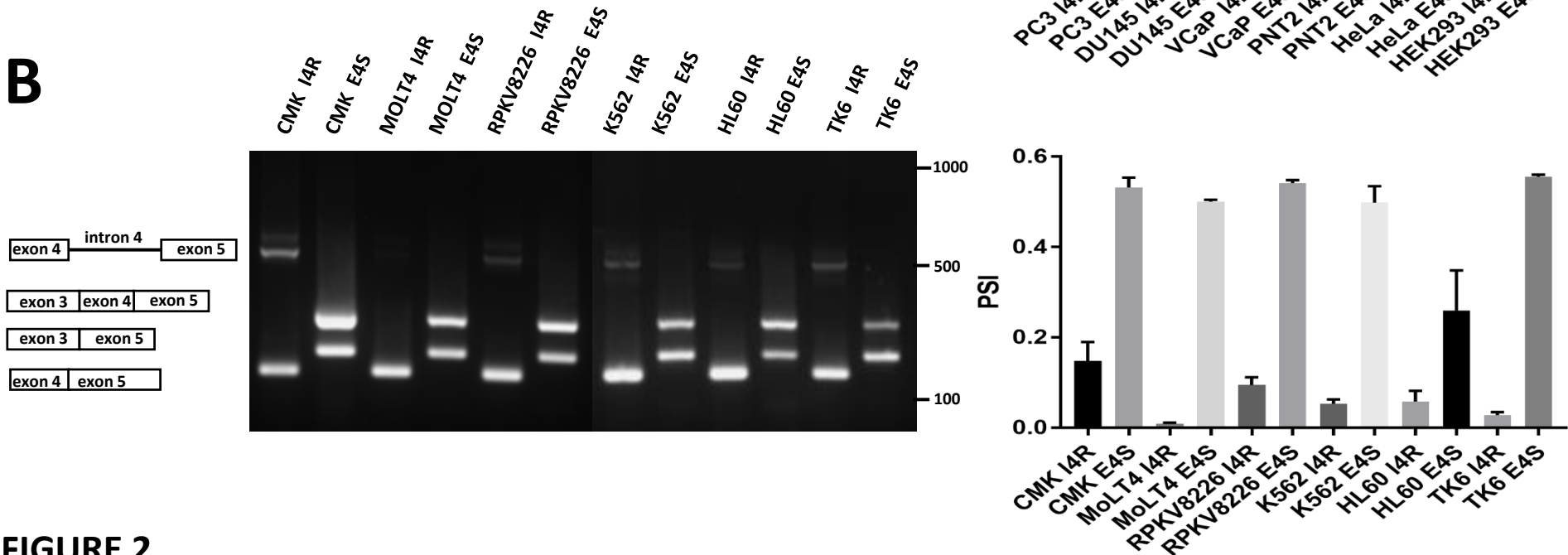

FIGURE 1AB



...aucuuggugccgcccacuugacguuu**ccagAAGAGUCACCGAAGGAAAAGAACCAGG**
AGUGUAGAGGAUGAUGAGGGUCACCUGAUCUGUCAGAGUGGAGACGUACUAAGUG
 CAAGAUguauagaau**auuuuuu**caacacuuau... ..uuuauuuucucucuuuuuagATG

FIGURE 1C

A**B****FIGURE 2**

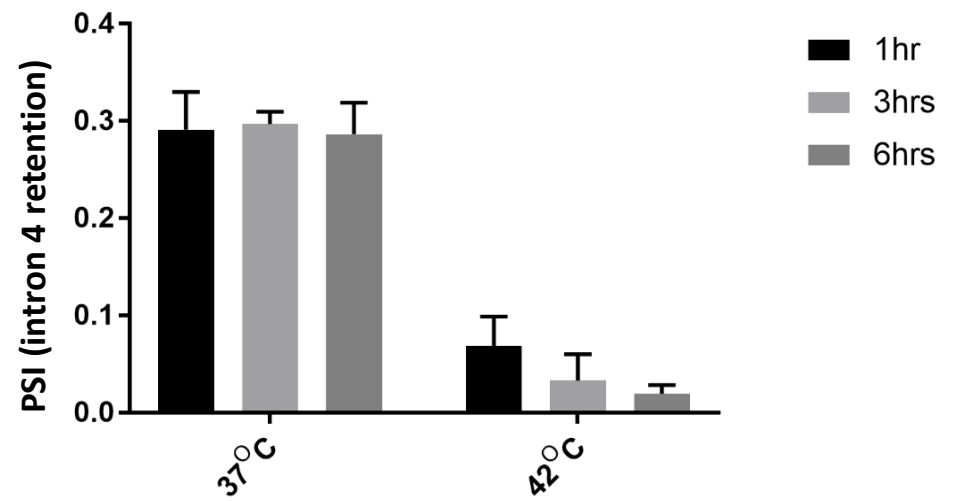
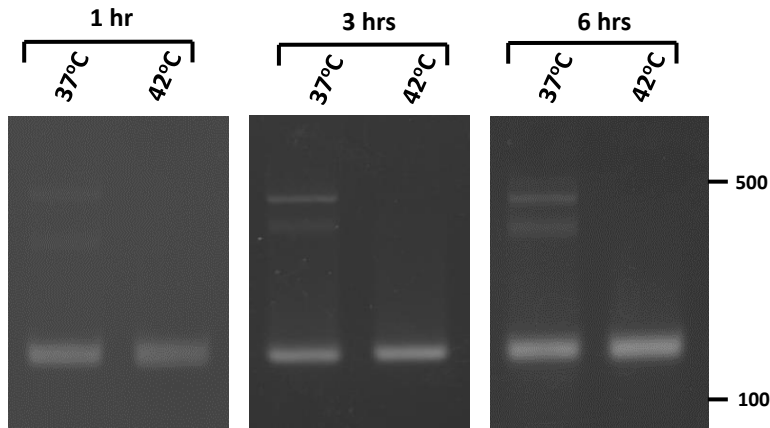
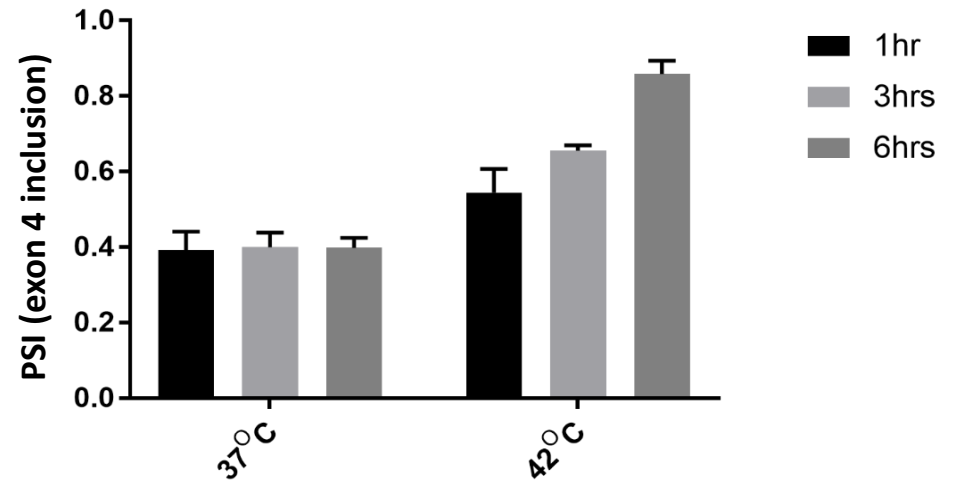
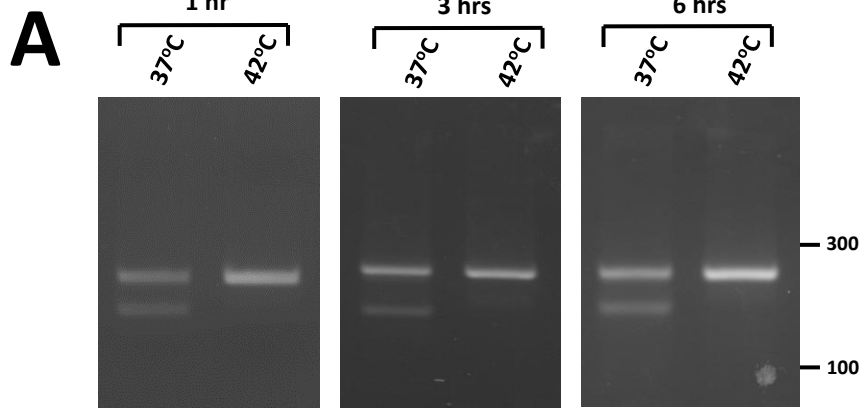

FIGURE 3A

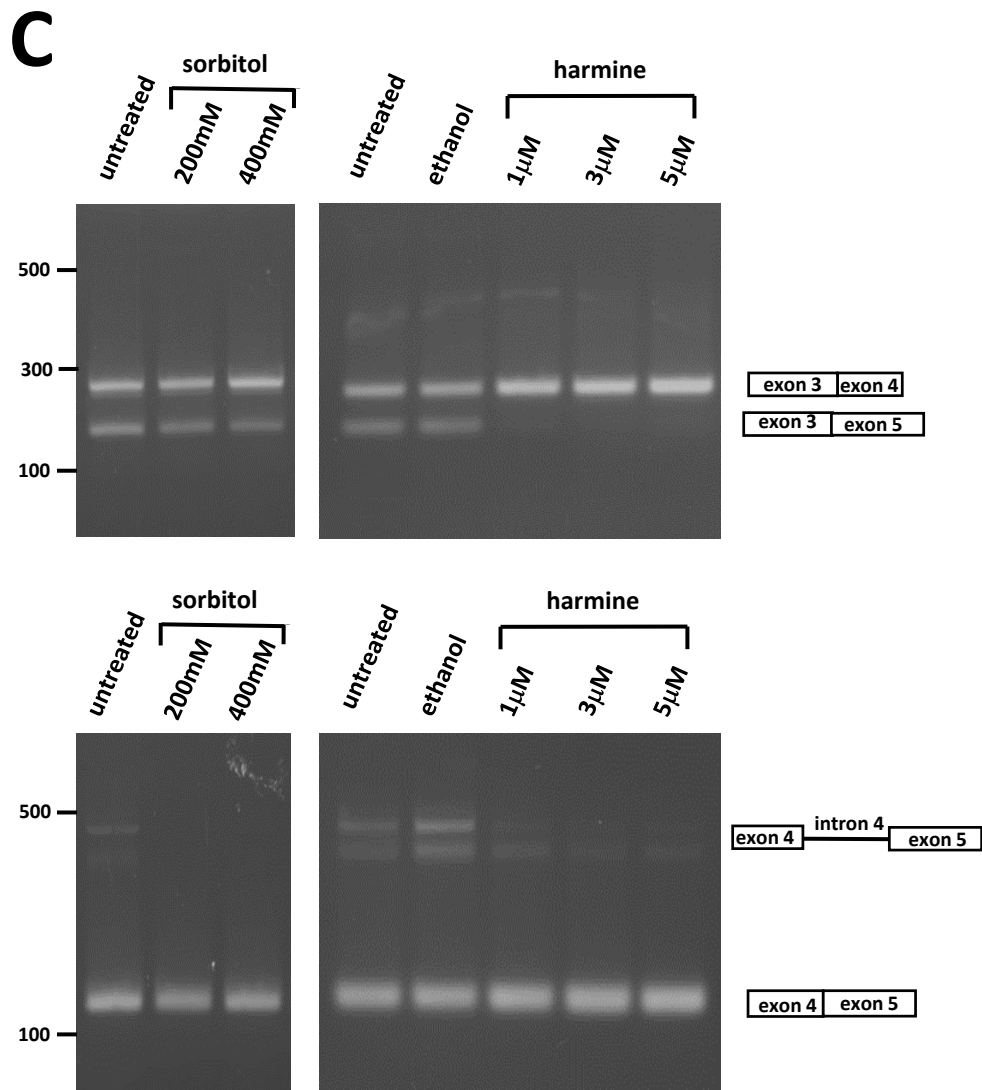
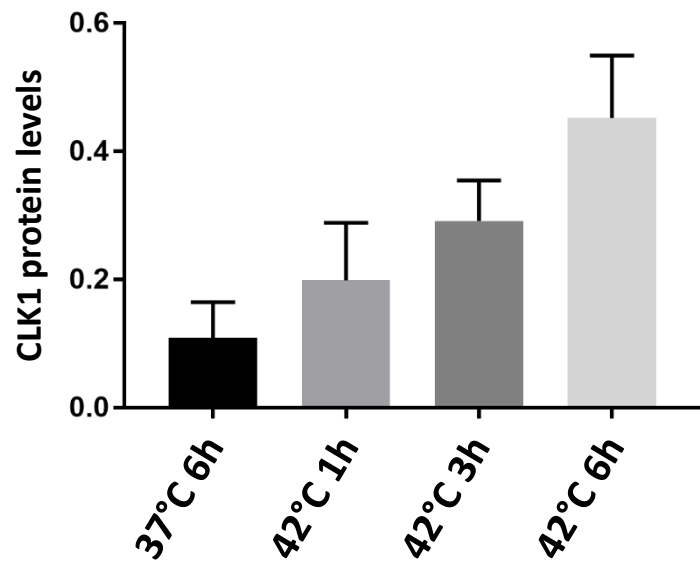
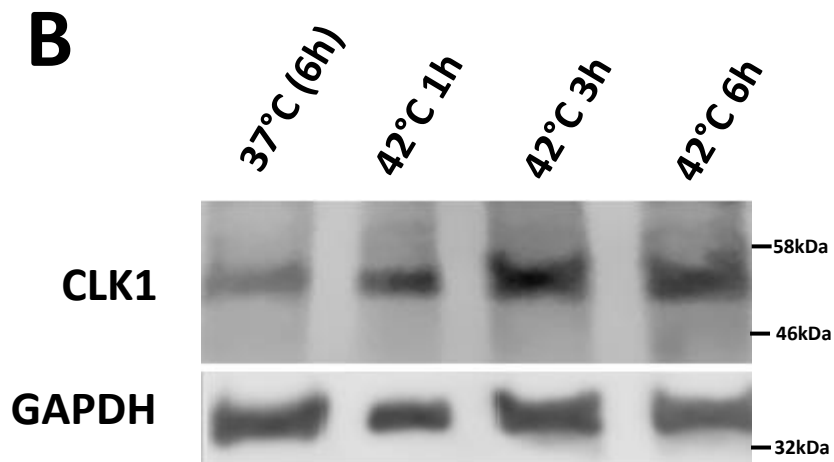
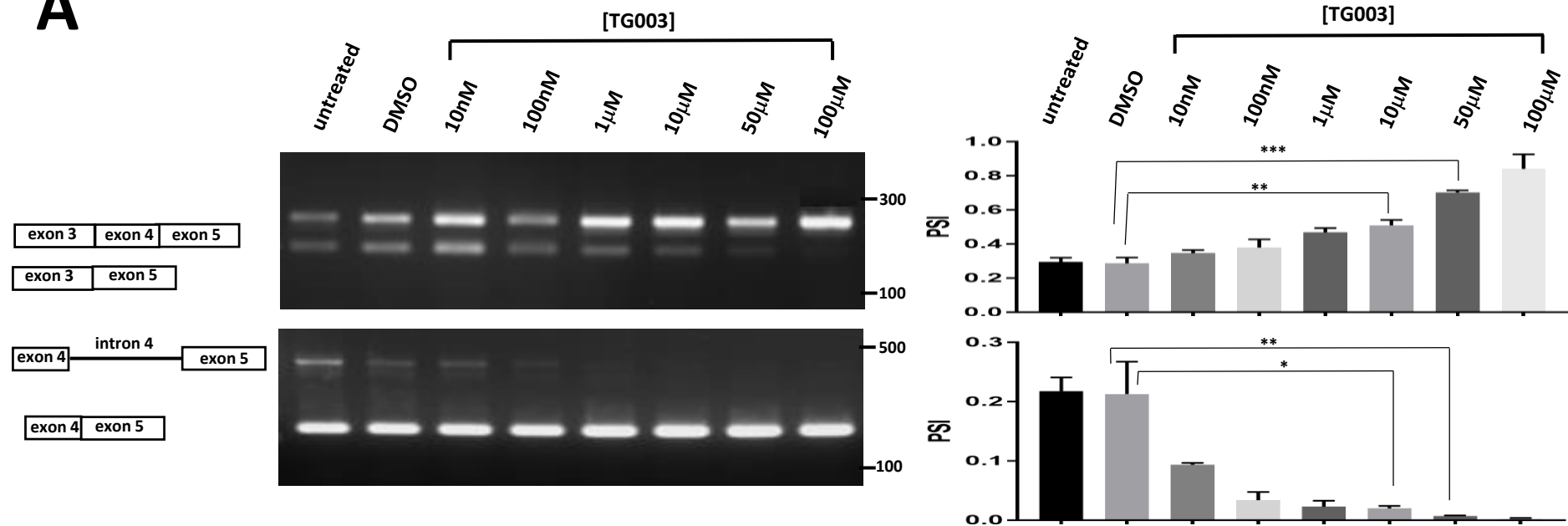
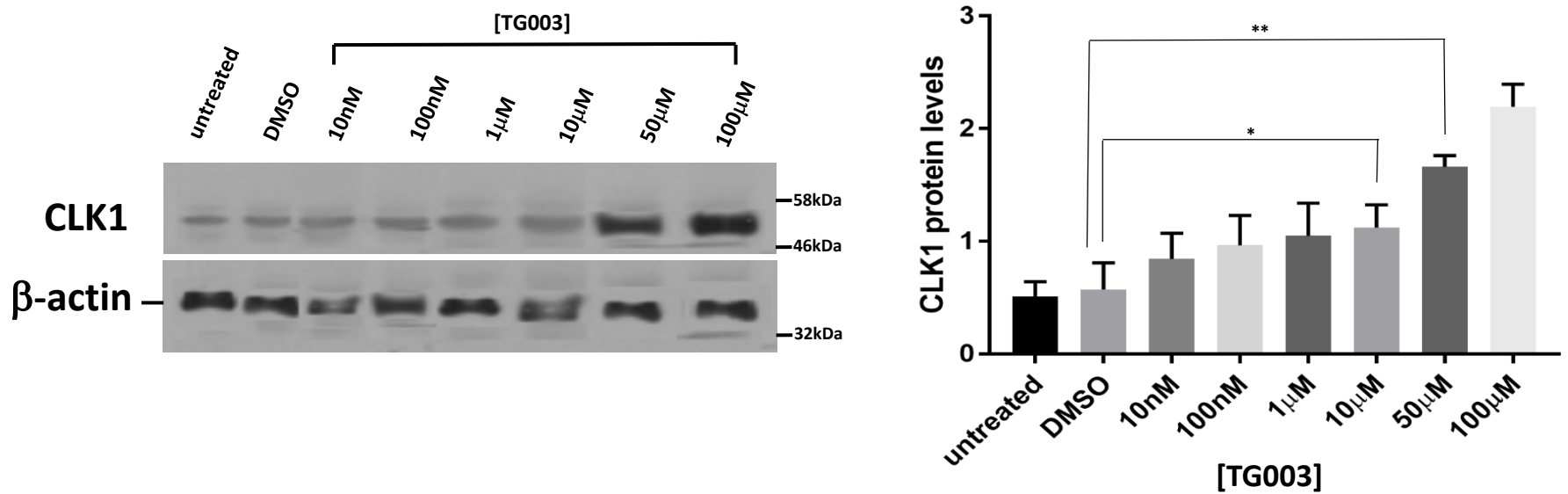
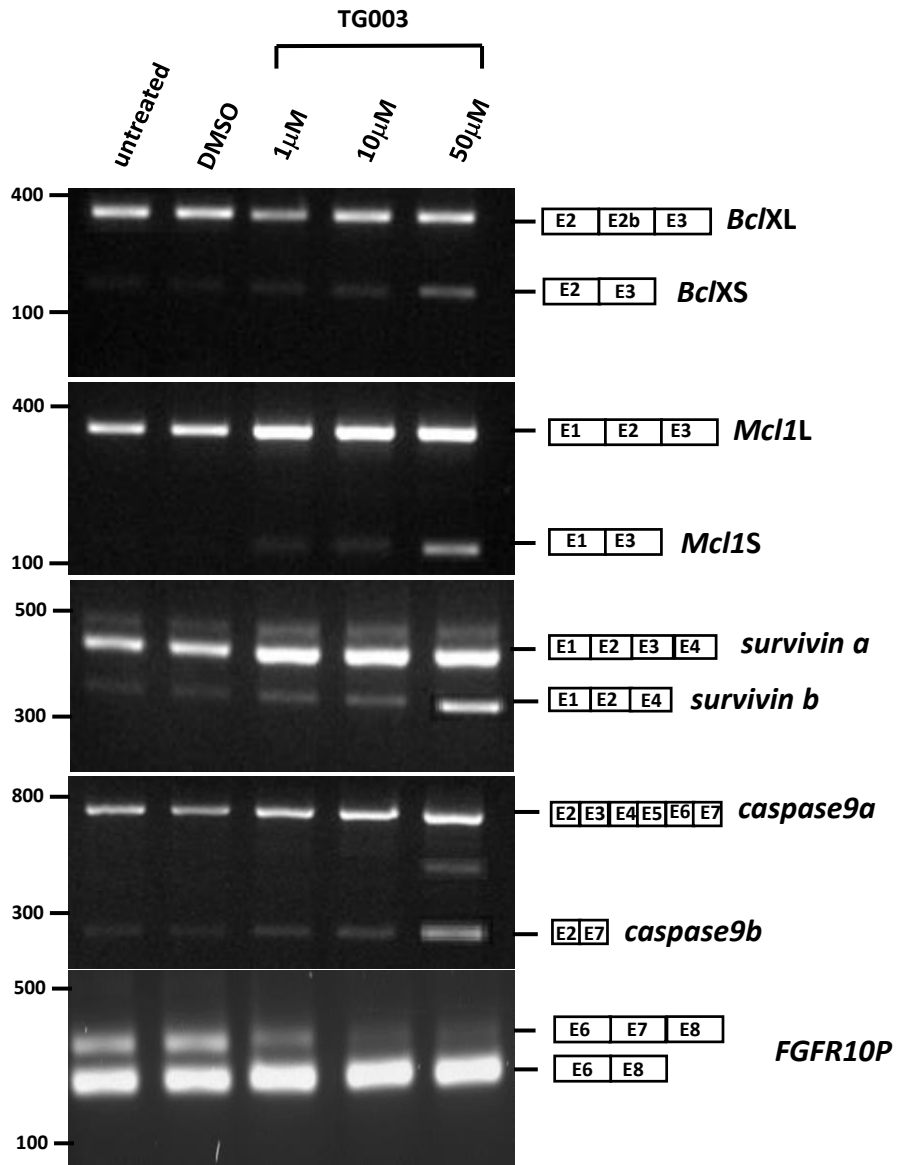

FIGURE 3BC

A**B****FIGURE 4AB**

C**FIGURE 4C**

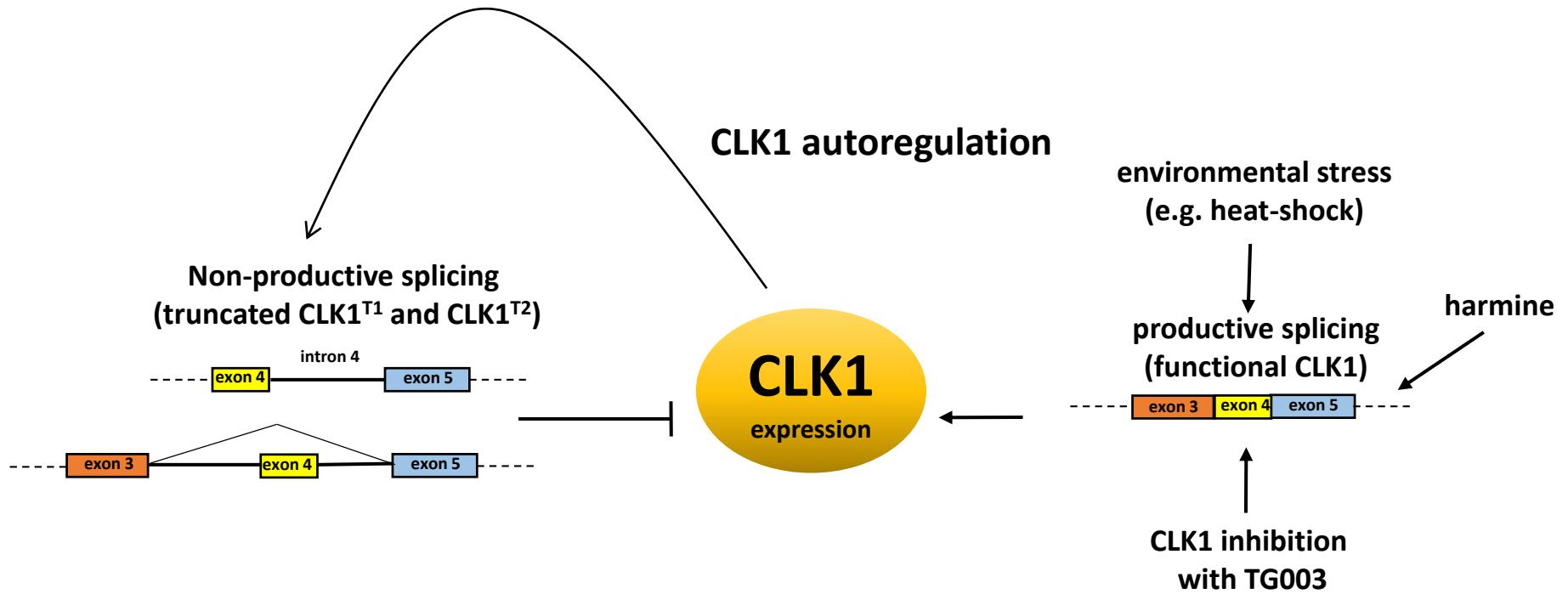

FIGURE 5