

**The Development of Methods
for the Reproduction in Continuous Tone
of Digitally Printed Colour Artworks**

Peter James McCallion

A thesis submitted in partial fulfilment of the requirements of the
University of the West of England, Bristol

For the degree of Doctor of Philosophy

Faculty of Arts, Creative Industries and Education
University of the West of England
September 2017

T&A Thanks and Acknowledgements

I want to take this opportunity to thank and acknowledge the people who provided me with the help, support, and guidance throughout this doctoral research project, from its conception to completion and at every stage in-between. I want to formally thank my supervisory team at the Centre for Fine Print Research. My Director of Studies, Professor Stephen Hoskins, you have provided me with mentorship, guidance and direction on this project. You helped me stay focused throughout and cross that final hurdle. My supervisors, Professor Carinna Parraman and Dr Peter Walters. Carinna you pushed me through the lulls that led to the significant turning points that developed the structure for the project. Pete your knowledge of manufacturing processes and materials was invaluable. In the moments of chaos you helped me start and keep going with a level head and a critical eye.

I want to thank the wider CFPR team. Dave Huson for letting me takeover his kilns and sharing his knowledge of Cartlidge Tiles. Jesse Heckstall-Smith and Joanna Montgomery you were always there in the background making the things happen that often go unnoticed but always appreciated, thank you. I want to thank Dr Paul Spencer for his infectious enthusiasm that helped keep me motivated throughout and without his research development programmes I never would have met Dr Peta Freestone and her fantastic Thesis Boot Camp. Dr Peter Moseley I want to thank you for introducing me to the Carbon Process and teaching me that beautiful process. A special thanks goes to Chris Bytheway for helping me to design, engineer and fabricate bespoke printing presses and produce 3D prints; to Mikaela Harding for her knowledge of chemicals and chemistry. Thanks to Frank Menger, David Sully, Atul Vadgama, Rick Drew and the fabrication team at UWE Bristol for the facilitation of resources and equipment. Dr Anne Hammond you tirelessly proof-read this thesis at the eleventh hour helping me iron out the wrinkles. Sarah Bodman and Tom Sowden thank you for preparing me for my Viva Voce and the reassurance that it would all be OK.

I'd like to thank Dr Michael Pritchard at the Royal Photographic Society for letting me read through his private collection of Victorian photographic journals. Justin Hobson at the Science & Society Picture Library for helping me locate and use many images. Paul Lamoureux at ColArt for providing me with a selection of inks. Tri-Tech3D for printing my colour lithophanes and EnvisonTEC for printing my continuous tone printing plates.

Last but not least Abbie. Thank you. Without you in my corner this project would not have been possible. Thank you for making me believe in myself and believing in me.

A The development of methods for the reproduction in continuous tone of digitally printed colour artworks

Advances in printing technologies in the late 19th century led to the development of half-toning techniques enabling the economical reproduction of photographic images in print. Whilst undoubtedly successful in low cost high volume image reproduction, half-toning representations are less faithful in detail when compared to continuous tone photomechanical methods in use at that time. This thesis asks the question: can the creative application of 21st century digital fabrication technologies enable the qualities of continuous tone imaging to be regained?

In the 21st-century, printmaking may be seen as the interchange of ideas, experimental practice and interdisciplinary thinking. Printmaking has always been a means of combining modern technology and methods with existing traditional and commercial imaging processes. Technological advancement in print however does not always provide a finer quality of print. Qualities often attributed to pre-digital continuous tone printing can be lost in the transition to a digital half-tone print workflow. This research project examines a near obsolete 19th century print process, the continuous-tone Woodburytype, developed to address the issue of permanence in photography.

Through a methodological approach analyses of the Woodburytype an empirical reconstruction of the process provides a comprehensive critique of its method. The Woodburytype's surface qualities are not found in other photomechanical printing methods capable of rendering finely detailed photographic images. Its method of image translation results in the printed tonal range being directly proportional to the deposition thickness of the printing ink, however it never successfully developed into a colour process. By examining and evaluating digital imaging technology this study identifies, current computer aided design and manufacturing techniques and extends upon known models of Woodburytype printing through the development of this deposition height quality enabling a new digital polychromatic colour printing process.

Table of Contents

1.0 Introduction

1.1	Looking back at print technology	1
1.1.1	The Woodburytype and its context within this research	3
1.1.2	Basic Half-tone process	3
1.2	Aim of this research	4
1.3	The objectives	4
1.4	Developing the work and contributions to new knowledge	7
1.4.1	The Structure of the Thesis	7
1.4.2	Chapter 1 - Introduction	8
1.4.3	Chapter 2 - Methodological approach to the research	8
1.4.4	Chapter 3 - Historical developments in photography and printing	9
1.4.5	Chapter 4 - Gaining base knowledge through the reassessment of the Woodburytype process	10
1.4.6	Chapter 5 - Contemporary knowledge of digital print technology and testing methods	11
1.4.7	Chapter 6 - Printed results of the new method for the reproduction in continuous tone of digitally presented artworks..	11
1.4.8	Chapter 7 - Conclusions.	12
1.5	My background and position within the Centre for Fine Print Research	12
1.5.1	Could CAD/CAM reintroduce qualities from 19th century monochromatic processes but render them in colour?	
1.6	Previous Research	12
1.6.1	Print research at the University of the West of England and the Centre for Fine Print Research.	13
1.6.2	Paul Thirkell.	13
1.6.3	David Huson	13
1.6.4	Andrew Atkinson.	13
1.7	Baselines and assumptions within the research.	15
1.8	Printing terminology	15
1.8.1	What is a print?.	16

1.8.2	Intaglio Printing	16
1.8.3	Continuous-tone and half-tone	17
1.8.4	Photoplastography	19
1.8.5	New terminology	20
1.8.6	Semi Continuous-tone	22
1.9	Next chapter	22

2 Methodological Approach

2.1	Introduction	23
2.2	Knowledge and intellectual abilities	25
2.2.1	Methodological approach	25
2.2.3	Research for art approaches	26
2.3	Methodological models and methods used to conduct the research	27
2.3.1	Research into 'print'	27
2.3.2	Research through 'print'	27
2.3.3	Research for 'print'.	27
2.4	Methods of conducting the literature review and historical documents sources	28
2.4.1	Archival visits, on-line digital archives and on-line communities	28
2.4.2	The British Library	29
2.4.3	e-theses on-line services (EThOS)	29
2.4.4	Library of Congress	29
2.4.5	Royal Photographic Society.	30
2.4.6	The Photographic Society of London, and its publication The Photographic Journal.	30
2.4.7	British Journal of Photography	30
2.4.8	The Photographic News (1858-1908) & The Yearbook of Photography and Photographic News Almanac	31
2.4.9	Centre for Fine Print Research Woodburytype Archive	31
2.4.10	Open source databases – Google Scholar	31
2.4.11	British Newspaper Archives	31
2.4.12	Intellectual Property Office (IPO)– Searchable Patents Journal.	31
2.4.13	St Brides Photographic Library (London)	32

2.4.14	Contemporary literature review32
2.4.15	Nicolai Klimasezewski (1994)32
2.4.16	Andrew Atkinson (2005).32
2.4.17	Barret Oliver (2006)32
2.4.18	RPS & Alan Elliott (2008).33
2.4.19	Chuck Close (2012).33
2.4.20	Factum-Arte (2016)33
2.4.21	Empirical observation of process33
2.4.22	Carbon transfer process workshop34
2.4.23	Wet plate collodion demonstrations34
2.4.24	Albumen printing workshop34
2.4.25	Video Sharing – YouTube and Vimeo.34
2.4.26	On-line forums and digital communities35
2.5	Empirical Investigation35
2.5.1	Empirical observation and measurement.36
2.5.2	Identification of known key variables and controls through literature36
2.5.3	Identification of new key variables and controls through testing methods36
2.5.4	International Standards and test prints.37
2.5.5	Measuring devices.37
2.6	Ethics37
2.7	Multiple methods and triangulation approaches37
2.7.1	Empirical development and testing38
2.7.2	Action research38
2.8	Qualitative and quantitative39
2.9	In summary.39
3	Historical Developments	
3.1	Literature review specific to this chapter40
3.1.1	Photographic history40
3.1.2	Photomechanical print history.41
3.1.3	Identifying prints and colour42
3.1.4	Gelatine processes, Carbon Transfer and the Woodburytype printing process.43

3.2	Historical Timeline of key photographic events leading to the Woodburytype	43
3.3	Historical analysis of the Woodburytype	54
3.3.1	The Woodburytype and its context within this research	54
3.3.2	Development of the process	56
3.4	Simplified Woodburytype process – key stages	59
3.5	The Woodburytype process – illustrations of key stages.	59
3.6	Financial advantage of commercial Woodburytype printing.	65
3.7	Industrial limitations of the Woodburytype.	65
3.7.1	High labour expenditure and time constraints.	65
3.7.2	Hydraulic press.	65
3.7.3	Attempts in colour.	66
3.7.4	Cost of investment and poor business acumen	67
3.7.5	Open and closed process.	68
3.7.6	Fixation and isolation.	69
3.7.7	Health and later years.	69
3.8	In summary.	71
3.8.1	Next Chapter - Chapter 4	72
4	Gaining historical knowledge through the reassessment of the Woodburytype process	
4.1	The relevance of this Woodburytype study	73
4.2	Presentation of information	74
4.2.1	Stages	74
4.2.2	Steps.	74
4.2.3	Summary	74
4.3	The Woodburytype process.	75
4.3.1	Photographic input image	75
4.3.2	Tissue manufacture & sensitising	75
4.3.3	Photographic exposure.	75
4.3.4	Developing process	75
4.3.5	Printing plate generation	75
4.3.6	Receiving substrate	75
4.3.7	Printing process	75
4.3.8	Print finishing.	75

4.4	Risk management and identifying areas of knowledge.76
4.4.1	Historical literature surveys78
4.4.2	Knowing the limitations of the process79
4.5	Stage 1 - Photographic input image79
4.5.1	Tonal ranges81
4.5.2	Positive or negative images.83
4.5.3	Enlarging and reducing sizes83
4.5.4	Framing the image84
4.5.5	Size restrictions85
4.6	Stage 2 - Photographic tissue generation.87
4.6.1	Spreading support.87
4.6.2	Traditional spreading supports87
4.6.3	Glass plate support87
4.6.4	Talc (Optional)89
4.6.5	Mica (Optional).89
4.6.6	Paper (Optional)89
4.6.7	Alternative spreading supports89
4.6.8	Acrylic and Polycarbonate89
4.6.9	Paper, paper substitutes and other flexible face substrates..89
4.6.10	Paper90
4.6.11	Acetate90
4.6.12	Synthetic Paper90
4.6.13	Medical Imaging Film90
4.6.14	Opaque materials90
4.6.15	Release agents (optional)91
4.6.16	Ox gall91
4.6.17	Transparent base support91
4.6.18	Collodion coating92
4.6.19	Flowing the collodion92
4.6.20	Variation of base structure - sensitized gelatine and skinning93
4.6.21	No support material or support added at a later stage93
4.6.22	Gelatine tissue mix93
4.6.23	Units of measurement94
4.6.24	Recipes matrix94
4.6.25	Additive ingredients95

4.6.26	Storage of tissue mix95
4.6.27	Biocides95
4.6.28	Surface tension95
4.6.29	Purified water	96
4.6.30	Plasticisers	96
4.6.31	Soap	96
4.6.32	Bloom value and quality of gelatine97
4.6.33	Gelatine strength and initial thickness of tissue97
4.6.34	Pigmented tissue	98
4.6.35	Photosensitising chemicals	99
4.6.36	Dichromate stability.	99
4.6.37	Dichromate toxicity.	99
4.6.38	Environmental concern	100
4.6.39	21st century environmental cases.	100
4.6.40	Reducing toxicity and disposal of potassium dichromate	100
4.6.41	Non-carcinogenic variation.	101
4.6.42	Increase in photosensitivity	101
4.6.43	Dark effect and continuing effect	101
4.6.44	Making the photosensitive tissue	101
4.6.45	Pre-sensitized gelatine tissue mix	101
4.6.46	Gelatine tissue sensitized by brushing on sensitizer.	102
4.6.47	Gelatine tissue sensitized by bathing in sensitizer.	102
4.6.48	Tissue and sensitizer mix used in this study	103
4.6.49	Spreading the tissue	105
4.6.50	Tissue thickness	108
4.6.51	Cooling and drying times	109
4.6.52	Removal from glass plate	111
4.6.53	Storage of tissue	111
4.7	Stage 3 – Photographic exposure	113
4.7.1	Preparation of tissue for photographic exposure	113
4.7.2	Sunlight	114
4.7.3	Optical exposure aids	115
4.7.4	Artificial light sources	116
4.7.5	Exposure times.	117
4.7.6	Over and under exposure	118

4.7.7	Removal from printing frame	119
4.8	Developing - Stage 4	121
4.8.1	Washing supports	121
4.8.2	Preparation of the wash support	121
4.8.3	Washing out	124
4.8.4	Water bath	124
4.8.5	Developer temperatures	124
4.8.6	Developing times	126
4.8.7	Development aids	126
4.8.8	Finishing the developing	129
4.8.9	Sharpening the image (optional).	129
4.8.10	Manually painting a matrix (alternative relief production).	131
4.8.11	Hardening the image	131
4.8.12	Alternatives to chrome alum	132
4.8.13	Chrome alum.	133
4.8.14	Removal from support	133
4.9	Plate manufacturing.	137
4.9.1	Electrodeposition	137
4.9.2	Electroplating:	137
4.9.3	Heavy deposition:	137
4.9.4	Electroforming:	137
4.9.5	Making the non-conductive photo-relief conductive	138
4.9.6	Separating the electrodeposited plate and backing it.	141
4.9.7	Casting plates	141
4.9.8	Plates manufactured by impression.	143
4.9.9	Hydraulic presses	143
4.9.10	Cost of investment.	144
4.9.11	The Tangye Bros 18" hydraulic ram press.	144
4.9.12	Intaglio plate alloys	147
4.9.13	Platens	148
4.9.14	Positioning the relief on the platen	148
4.9.15	Boundary frames (optional)	149
4.9.16	Positioning the relief into the boundary frame (optional, hydraulic impression only)	149
4.9.17	Top platen.	149

4.9.18	Removal from boundary frame (optional, hydraulic only)	150
4.9.19	Best results and relief depth	150
4.9.20	Hydraulic pressure	150
4.9.21	Lead printing plates	152
4.9.22	Intaglios per relief	152
4.9.23	Plate editing (optional)	153
4.9.24	Casting plates	153
4.9.25	Stannotype process	157
4.10	Substrates	159
4.10.1	Paper substrates.	159
4.10.2	Calendering.	159
4.10.3	Sealing the paper with shellac	160
4.10.4	Surface emulsion / sizing and keying the surface	161
4.11	Stage 7 - Printing.	163
4.11.1	Preparing the platen (optional).	165
4.11.2	Preparing the print bed	165
4.11.3	Final intaglio preparation.	166
4.11.4	Removable platen (optional)	166
4.11.5	Printing ink	166
4.11.6	Setting strength	166
4.11.7	Ink concentration in relation to intaglio depression.	167
4.11.8	Pigment	167
4.11.9	Fluidity	168
4.11.10	Gelatine strength	169
4.11.11	Printing	171
4.12	Stage 8 - Fixing and finishing the print	175
4.12.1	Fixing the print.	175
4.12.2	Finishing the print	175
4.13	In summary.	178
4.13.1	Further development of historical process.	179
4.13.2	In the next chapter.	180
5	Review of contemporary technology for the colour development of the Woodburytype process	
5.1	Digital Imaging and transitioning from half-tone to continuous tone.	181

5.1.1	Analogue and digital images	181
5.2	Digital tones	182
5.2.1	Bit-depth	182
5.2.2	Dynamic range	182
5.2.3	Pixels	183
5.2.4	Bitmaps	183
5.2.5	256 greyscale.	184
5.3	Image resolutions	184
5.3.1	Spatial resolution	184
5.3.2	Intensity or 'tonal resolution'.	184
5.3.3	Pixel dimensions	184
5.3.4	Output / print resolution	184
5.3.5	Artefacts	184
5.3.6	Banding	184
5.3.7	Just noticeable differences	185
5.3.8	ΔE (Delta-E)	185
5.4	Viewing conditions.	186
5.4.1	Luminance and its effect on the observer	186
5.4.2	Illuminance and its effect on the observer	186
5.5	Acceptable number of grey levels for the dynamic range of human vision	186
5.6	Grey channels within colour digital images.	187
5.6.1	Colour separations.	187
5.6.2	Digital half-tones.	188
5.7	24 bit and 32 bit images.	191
5.8	Generating a 3 dimensional relief model through spatial and tonal resolution.	192
5.8.1	Greyscale height fields and bit depth	192
5.8.2	Subtractive manufacturing or CNC milling	193
5.8.3	Subtractive printing plate manufacturing by computer numerical control	196
5.8.4	CNC resolution.	196
5.8.5	Cutting, material removal and surface finish.	196
5.8.6	Stepover amount calculation.	197
5.9	3D print technology and additive manufacturing	198

5.9.1	Fused deposition modelling (FDM)	199
5.9.2	Laser engineered net shaping (LENS)	199
5.9.3	Laminated object manufacturing (LOM)	199
5.9.4	Photo-polymeric inkjet deposition (Polyjet Printing)	199
5.9.5	Stereolithography (SLA).	199
5.9.6	Direct metal laser sintering (DMLS) / laser sintering (LS)	199
5.9.7	Three dimensional printing (3DP) / powder binder 3D printing	199
5.9.8	Digital light processing (DLP)	199
5.10	Actual losses and perceptual gains	202
5.10.1	Tool smoothing, tonal half-steps and sub-pixel resolution detail.	202
5.10.2	Semi-continuous tone.	202
5.10.3	Perceptual information gains through relief surfaces.	202
5.10.4	Perceptual information gains through viewing distance	203
5.11	Definition of colour and the subjectivity of testing	204
5.11.1	Colour constancy	204
5.11.2	Metamerisms.	205
5.11.3	Colour checker	205
5.11.4	Accuracy and fidelity	205
5.11.5	Colour memory	206
5.12	Colour management.	206
5.12.1	Standard colorimetric observer	207
5.12.2	Colour science and mathematical measurement	208
5.12.3	Subjective qualitative testing.	208
5.12.4	Initial and final quality assessment	209
5.13	Goethe's steigerung (gradual ascent) of colour.	211
5.13.1	Colour identification with illumination cues	211
5.13.2	Adams' zone system for tonal ranges	212
5.13.3	Fineness of grind draw down test / Stoufer Wedge	212
5.13.4	256 Steps and image test	216
5.14	In summary.	218
5.14.1	Next chapter	218
6	Colour printing method for the reproduction in continuous tone of digitally printed colour artworks	
6.1	Further development of a printing process	219
6.1.1	Development of a plastographic ink.	220

6.1.2	Silicone ink - initial test221
6.1.3	Silicone ink initial observation224
6.2	Photographic relief226
6.2.1	Stannotype surface / surface barrier227
6.2.2	Wax barrier release agent227
6.2.3	Initial paper substrate tests227
6.2.4	Surface finishes228
6.3	First steps to two-colour imaging231
6.3.1	Duotone printing.235
6.3.2	Duotone printing observations237
6.3.3	Two colour separation from different plates237
6.3.4	Two colour printing observations237
6.3.5	Overall duotone and two colour observations.237
6.4	Tertiary colours239
6.4.1	Three colour swatch observations.245
6.5	Photo-realistic rendering246
6.5.1	Tri-chromatic photo-realistic renderings in silicone.250
6.6	Results of tri-chromatic photo-realistic rendering in silicone255
6.6.1	Results of tri-chromatic photo-realistic rendering in silicone255
6.6.2	Children's toy owl image261
6.7	Re-evaluation of the Digital Woodburytype model to a polychromatic process269
6.7.1	Silicone printing plates269
6.7.2	Advances in 3D printing.271
6.8	Colour registration for silicone printing plates271
6.9	Substrates for colour printing272
6.10	Colour printing method.273
6.10.1	Wet on wet printing273
6.10.2	Wet on dry printing276
6.10.3	Finishing processes276
6.11	Microscope image captures and print comparison279
6.12	Additional observations293
6.13	In summary.296

7	Conclusion and areas for further research	
7	Conclusion and areas for further research297
A4	Appendix for chapter 4301
A5	Appendix for chapter 5342
A6	Appendix for chapter 6346
B	Bibliography363

1.0 Introduction

Synopsis: At the beginning of the 20th century, commercial printing methods focused primarily on the half-tone screening process. Modern 21st century commercial printing processes are still based on evolutions and variations of the half-toning process. The half-tone process is a versatile and efficient method of image translation in commercial printing. While versatile, this method also reduces and loses a portion of the mid-range in tonality contained within photographic images. However some processes preceding this method, towards the end of the 19th century, were capable of mechanically printing photographic image tones and did not rely on the halftone translation process. These methods did not restrict the gamut of mid-tones in the same manner and were quite often mistaken for photographs. This chapter introduces and reflects on printing methods that do not rely on half-toning of images, positioning their relevance to this thesis.

“Life imitates art. We shape our tools and thereafter they shape us”^[1]

FATHER JOHN CULKIN ON MARSHALL MCLUHAN

1.1 Looking back at print technology

In the 21st century, print is seen as the interchange of ideas, experimental practice and interdisciplinary thinking (Catanese & Geary, 2012) ^[2], and discussed globally by practitioners and scholars (Impact Conference, 2014) ^[3] (The Image Conference, 2015) ^[4]. Research in this thesis aims to contribute to this exchange of ideas and experimental approach. It has been debated and acknowledged that digital printing has influenced how we now look at the printed image, (Lowe, 1997) ^[5]. The ubiquity of 21st century technology enables us to capture, view and reproduce images with an acceptable

1 Culkin, J., 1967, March 18. A schoolman’s guide to Marshall McLuhan. Saturday Review, pp. 51-53, 71-72.

2 Catanese, P. and GEARY, A., 2012. Post-Digital Printmaking. CNC, Traditional and Hybrid Techniques. 1 edn. London: Bloomsbury.

3 Impact Impact 8 - Borders and Crossings, the Artist as an Explorer. Available from: <http://www.conf.dundee.ac.uk/impact8/schedule/> Accessed 04/05/2015.

4 The Image International Conference on the Image, Berlin 2014. Available from: <http://ontheimage.com/the-conference-2013/program-and-events/#Program> Accessed 04/05/2015.

5 Lowe, A. (1997) Digital Prints, Conceived and Edited by Adam Lowe 50 pages Edition of 50 box sets plus 500 hardback books. At: London: Permaprint London.

degree of fidelity of colour, resolution and tone across a multitude of devices. It seems that users of hand held devices for example, are less inclined to print images and more likely to view on a screen. As users we are now used to seeing digitally printed reproductions from images that have been processed or manipulated at some stage by viewing through a visual display unit (VDU). We are used to seeing colour reproductions as prints from half-toned screened processes such as inkjet, silkscreen and offset lithography etc. However what are the qualities that may have been lost or gained through the translation from an input device such as a camera, through an imaging pipeline eg a personal computer (PC) and eventually to print? Furthermore, what has influenced this change and how does this relate to printing?

Looking back over 150 years of image reproduction, the major milestones in capturing and reproducing images is generally acknowledged to be in half-toning techniques and photography (Lau & Ace, 2008) ^[6], (Baquai, Lee, Ufuk Agar & Allebach, 2005) ^[7], (Johnson,2005) ^[8] .

In the mid 19th century scientists such as Fox Talbot (Weaver, 1992) ^[9] and photographic practitioners (Crawford 1979) ^[10] were experimenting with capturing light and fixing images to paper though chemical means. While these were astonishing at the time permanence was difficult to achieve, and in 1855 the Photographic Society of London set up a Fading Committee to investigate the various causes of fading (Gernshiem 1955) ^[11] . The Duc de Luynes, a member of the Institut de France and of the Société Française de Photographie offered awards of 10,000f for the development of the best method of photomechanical printing (8,000f) and permanent pigment based prints (2,000f) (Newhall,1964) ^[12] . Both prizes were awarded to Alphonse Poitevin for his development of the Carbon Process (Wilson 1868) ^[13] (Duc de Luynes Gold Medal 1859) and for the Photolithographic (collotype) in 1867 (Photographic Journal, 1867) ^[14], (Fowler, 1867) ^[15].

-
- 6 Lau, D.L. and Ace, G. (2008) Modern Digital Halftoning. 2nd ed. CRC Press, Taylor & Francis Group.
 - 7 Baquai, F.A., Lee, J., Ufuk Agar, A. and Allebach, J.P. (2005) Digital Color Halftoning. Problems, algorithms, and recent trends. Ieee Signal Processing Magazine. (January), pp.87.
 - 8 Johnson, H. (2005) Mastering Digital Print. 2nd ed. USA: Thomson Course Technology PTR.
 - 9 Weaver, M., ed. (1992) Henry Fox Talbot, Selected Texts and Bibliography. 1st ed. Oxford, England: Clio Press.
 - 10 Crawford, W. (1979) The Keepers of Light. A History & Working Guide to Early Photographic Processes. 1st ed. New York: Morgan & Morgan Ltd.
 - 11 Gernsheim, H. and Gernsheim, A. (1955) The History of Photography. from the Earliest use of the Camera Obscura in the Eleventh Century Up to 1914. 1st ed. London: Oxford University Press.
 - 12 Newhall, B. (1964) The History of Photography. 1st ed. New York: The Museum of Modern Art, New York.
 - 13 Wilson, E.L. (1868) The American Carbon Manual. Scovill Manufacturing Company.
 - 14 Unknown (1867) Report of the Commission of the French Photographic Society for Awarding the Prize of 8000 Francs by the Duc De Luynes for Printing Photographs in Ink. The Photographic Journal. 12 (July 16), pp.64-78.
 - 15 Fowler, R.J. (24/05/1867) The History of the Processes for the Production of Permanent Photographic Pictures in Printers' Inks (Part 2). British Journal of Photography. XIV

Mechanically the problem was initially solved by the development of the Woodburytype in 1864. What makes this process of interest to this research is that this method of printing did not rely on half-toning technology as the method of printing and it was never able to address the issue of colour imaging.

1.1.1 The Woodburytype and its context within this research

There was an imperative in the 19th century to find a printing method that could firstly prevent a printed photographic image from fading, and secondly to be able to mass reproduce reproductions of photographic images mechanically. The Woodburytype was another printing method developed to address this challenge put forward by the “Institut de France and of the Société Française de Photographie” on permanency in photographic reproduction, (Fowler, R.J., 1867)^[16] While Poitevin achieved gold the Woodburytype process earned its inventor a silver medal award (The Photographic Journal, 1867)^[17]. Examples of original 19thC Woodburytypes show no signs of fading while the opposite can be said of the Woodburytype process.

1.1.2 Basic half-tone process

Further advances in printing technologies in the late 19th century enabled printers to commit a photograph to mechanical print, through the development of half-toning techniques, and which has dominated how images are reproduced. (Nadeau, 1989)^[18]

Explained in more detail in Chapter 5 the half-tone process in very simple terms is a method of converting a photographic image into a series of lines and dots so that it can be printed on a printing press with ink. The process was further developed into a full colour variation.

It has been said by theorist Paul Virilio (1999),^[19] that through technological advancement there is both a skill and quality that becomes forgotten or made redundant. For every gain there is a loss. He claims that people tend to shift their focus to the hype of technology but dismiss its less favourable aspects. It is in this approach in looking at what was lost through technological advancement but also what could be gained and regained that lead to this doctoral research project. Gains that can be seen in the leap from chemical wet process photography to paper and ink enabled economical reproduction of photographic images in print. These could be widely

¹⁶ Fowler, R.J. (24/05/1867) The History of the Processes for the Production of Permanent Photographic Pictures in Printers' Inks (Part 2). British Journal of Photography. XIV.

¹⁷ Anonymous (1867) Permanent Printing. The Photographic Journal. (Oct 15), pp.115.

¹⁸ Nadeau, L. Encyclopedia of Printing, Photographic, and Photomechanical Processes: A Comprehensive Reference to Reproduction Technologies, Containing Invaluable Information on Over 1500 Processes online. Fredericton, N.B., Canada : L. Nadeau, c1989-c1990.

¹⁹ Armitage, J., 1999. From Modernism to Hypermodernism and Beyond, An Interview with Paul Virilio. Theory, Culture & Society, Vol. 16((5-6)), pp. 25-55.

disseminated allowing images to become more accessible. The half-tone process undoubtedly brought economy, speed and value but could it be argued that this advance cost the loss of artistic craftsmanship, quality and inadvertently focused print development by half-tone translation throughout the next century.

This research enquiry is situated between the photograph and the halftone print and asks: can the creative application of 21st century digital fabrication technologies enable the qualities of continuous tone image to be regained?

1.2 Aim of this research

The aim of the thesis is to bridge the gap between digital and analogue by looking at the stages between ensuring a photograph’s longevity and the mechanical reproducibility of the image, thus investigating the potential of a digitally produced alternative to the halftone process.

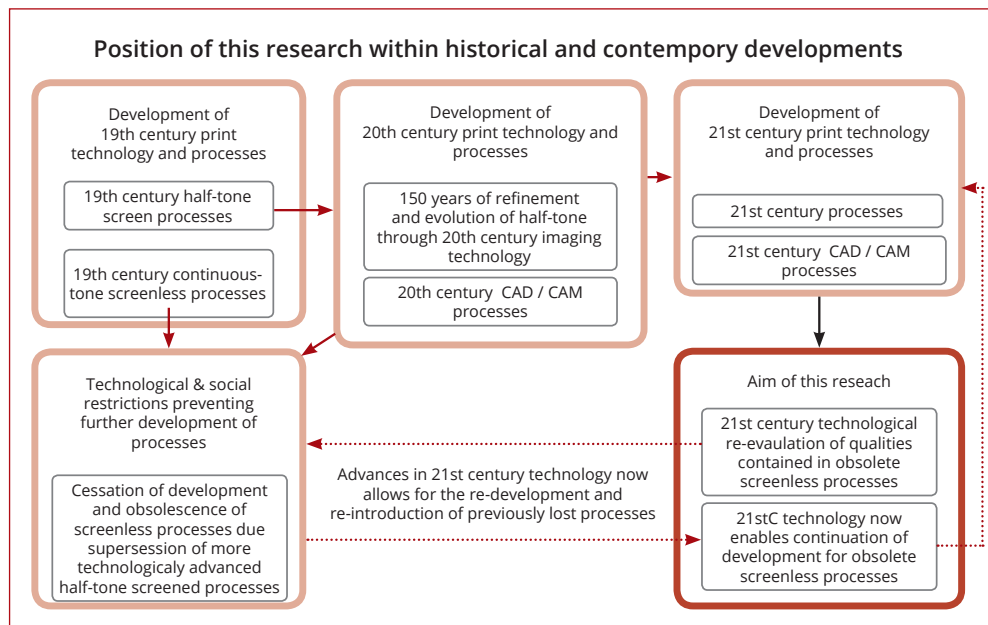

Figure 1.1: Position of this research within historical and contemporary developments

1.3 The objectives

This study examines processes that bridge the time gap between photography and photomechanical. It investigates inventors and scientists who were attempting to technologically advance printed photographic reproduction through photomechanical continuous tone methods. These methods involved the use of photographic gelatine

processes and carbon pigments as a way of improving image permanence. They were also desirous of quality and craft, however there was limitations on the processes and this is discussed later in Chapter 4. This introduces the notion of subjective qualitative metrics and benchmarks used to question and determine what is an acceptable print. (Discussed further in Chapter 5)

A group of processes in the 19th century (defined as photoplastographic printing (Figure 1.8) are important to this research. Two processes within this family of printing – the photographic carbon process and its photomechanical equivalent, the Woodburytype process – demonstrated a quality that bridged the gap between photography and photographic images in print by being able to permanently produce a full photographic tonal range. The next technological challenge in printing was to print photographic imagery and text simultaneously. However, due to the topographical surface structure of Woodburytype prints and how they were produced this was not possible and over time the process became moribund. Whilst the Woodburytype has been revived ad hoc by artists (Sultan, 2014)^[20] and historians (Oliver, 2007)^[21], it has been largely dormant for 88 years.^[22]

This thesis examines a specific topographical feature common across two 19th-century processes: the photographic carbon process and the photomechanical equivalent the Woodburytype process. Both processes translate the highlights and shadows contained within a photograph into a physical surface relief that is transferred to a sheet of paper or glass. They achieve this quality through using gelatine as a printing medium where as the print dries, the relief reduces in height until it looks flat in appearance. The fidelity and quality of carbon prints and Woodburytypes when compared to silver photographic prints was so high that to the untrained eye they were often mistaken for photographs themselves (Gernsheim, 1987)^[23]

Since the turn of the 20th century however more focus was on half-tone methods of printing which are generally considered to be coarser in detail for the reproduction of photographic images. Whilst undoubtedly successful in low cost, high volume image reproduction, half-toning representations are less refined in detail when compared to continuous tone photomechanical methods in use at that time, but the half-tone process addressed the issue of reproducibility of simultaneous text and image successfully.

20 Sultan, T. (2014) *Chuck Close Prints: Process and Collaboration*. 1st ed. Prestel Verlag.

21 Barret, O. (2007) *A History of the Woodburytype*. 1st ed. Nevada City, California: Carl Mautz publishing.

22 This time frame was correct at the time of the thesis submission September 2016

23 Gernsheim, H. and Gernsheim, A. (1987) *The History of Photography Volume II. the Rise of Photography 1850-1880. the Age of Collodion*. 3rd ed. London: Thames and Hudson.

Through an assessment of current digital technology, the aim of the thesis is to consider whether it is possible to create a colour separation printing process not based upon half-toning which provides us with insights into an alternative print method not predicated on the half-tone but based on a physical height as in the Woodburytype process.

In a digital age the four colour half-tone separation carried on due to the ease of transcription of 32-bit colour images into individual 8-bit separations (Chapter 5). This process is no longer essential in image generation and this thesis questions the need to continue to use half-toning by demonstrating an alternative approach to colour printing (Chapter 6).

1.4 Developing the work and contributions to new knowledge

1.4.1 The Structure of the Thesis

This thesis is presented in seven chapters. The following diagram highlights the relationship between chapters.

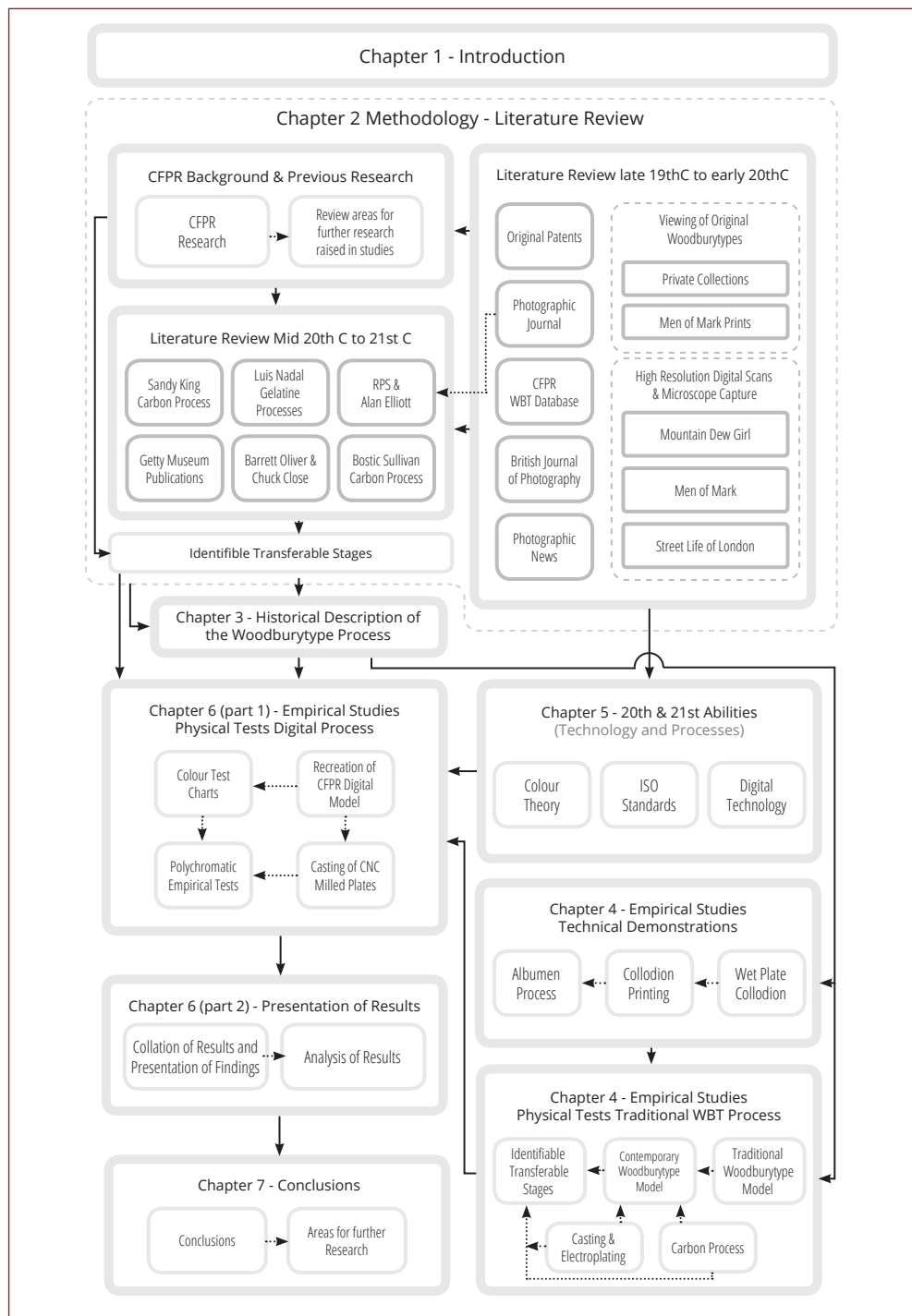

Figure 1.2: Flow diagram representing the structure of the research and layout of the thesis.

1.4.2 Chapter 1 - Introduction

Chapter 1 begins by introducing some of the baseline assumptions to this research. It identifies the aims and objectives of the research and where the new contributions to knowledge lie within this doctoral thesis. The chapter provides information on the researcher's background and his position within the Centre for Fine Print Research at the University of the West of England. Previous research taken at the research centre that is relevant to this study will be summarised. At the end of the chapter key terminology that is used throughout the thesis will be clarified.

1.4.3 Chapter 2 - Methodological approach to the research

Chapter 2 outlines the methodological approach to the research. The aim of this chapter is to convey the process of inquiry that is used throughout this doctoral study. It provides an overview of the methodologies that were used to determine the specific methods employed. It is believed that in its timeframe of 64 years, the process was only commercially active for approximately 35 years. Although the process never truly became extinct it has been largely obsolete for the past 88 years^[24] with the occasional photography and print historian attempting to revive the process, most with mixed levels of success and failure. A comprehensive literature survey of the publications prior to 1928 was done to understand the stages of Woodburytype production. These accounts were written when the process was commercially active by the inventor, licensees, eyewitnesses of demonstrations and authorities on photography at the time. These accounts contain detailed recipes, partial recipes and descriptions. Through this large literature review it was identified there was an incompleteness and discrepancy between the historical printing methods being investigated.

Accounts printed after 1928 do not contain the same level of detail as the initial journal accounts. It is quite common to see the same text almost verbatim in multiple publications as reports were repeated amongst the *Photographic News*, *Photographic Journal* and the *British Journal of Photography*. The Royal Photographic Society's journal entries after 1960 tend to be retrospective articles that reprint the original report, looking back in time. The original journal articles were the core sources in the historical chapter of this thesis in the understanding of the process. There has been little contemporary writing on the Woodburytype as a functioning process in the past 90 years that enabled the reader to follow the process from start to finish. The Royal Photographic Society (RPS) (2008)^[25] and Oliver (2007)^[26] provide excellent contemporary analysis in understanding the social history and life of the inventor

²⁴ This time frame was correct at the time of the thesis submission September 2016

²⁵ The Royal Photographic Society, Victorian Chapter, 2008. Walter Woodbury. A Victorian Study. 1 edn. Melbourne, Australia: RPS Victorian Chapter.

²⁶ Barret, O., 2007. A history of the Woodburytype. 1 edn. Nevada City, California: Carl Mautz publishing.

but lack technical details. Other contemporary literature by Nadeau^{[27], [28]}; Crawford^[29]; Webb & Reed^[30]; and King^[31] provide excellent resources for the creation of the alternative gelatine processes.

In addition to the literature survey of Woodburytype articles, original Woodburytypes had to be viewed. Literature on its own is not sufficient and the physical examples needed to be examined to appraise the quality of the process. Modern books are reproduced as half-tones so any fidelity of a continuous-tone print is destroyed when displayed in this manner.

The only process that can produce images that are of a similar kind to a Woodburytype are those produced through the carbon process. Images produced by the carbon process are not classed as prints and are considered photographic in nature. There are some distinguishable identifiable traits of a Woodburytype that are not present on Carbon process images. Therefore the only printing method capable of reproducing the qualities of a Woodburytype is the Woodburytype. This process cannot be replicated by any other traditional printing method. The visual assessment of original Woodburytype prints was required for the historical study.

The lack of practitioners has resulted in a de-skilling of the process. This de-skilling has meant that there was a need to undertake an empirical approach to rework the process in order to gain lost skills where one has had to work backwards (Carpenter, 2011)^[32]. This empirical study presented in Chapter 4 has led to a triangulation approach establishing the main contribution to knowledge of this thesis presented in Chapter 6.

1.4.4 Chapter 3 - Historical developments in photography and printing

Chapter 3 outlines a brief history of the developments in photography and printing that led to the development of the Woodburytype process. To understand the printing origins of this research project one must look at the developments in photography

-
- 27 NADEAU, L., 1986. Modern carbon printing: a practical guide to the ultimate in permanent photographic printing: monochrome carbon transfer and carbro. Fredericton, New Brunswick: Atelier Luis Nadeau.
 - 28 NADEAU, L., 1987. Gum Dichromate and other Direct Carbon Processes from Artigue to Zimmerman. 1 edn. Canada: Atelier Luis Nadeau.
 - 29 CRAWFORD, W., 1979. The Keepers of Light. A history & working guide to early photographic processes. 1 edn. New York: Morgan & Morgan Ltd.
 - 30 WEBB, R. and REED, M., 1999. Spirt of Salts. A working guide to old Photographic Processes. London: Argentum, Aurum Press.
 - 31 KING, S., 2003. The Book of Carbon and Carbro. Contemporary Procedures for Monochrome Pigment Printmaking. 1 edn. Greenville, South Carolina: Permanent Light Systems.
 - 32 CARPENTER, E., 2011. Social Making. In: D. CHARNY, ed, The Power of Making, The importance of being skilled. 1 edn. London: V&A Publishing and the Crafts Council, pp. 48

and printmaking in the 19th century and learn why specific processes were being developed. In the 1800s there was a drive to achieve two things in photography. The work of Wedgwood, Niépce and Fox Talbot advanced photography into a repeatable chemical process where images are fixed onto paper. However this technological advancement of capturing an image with photosensitive chemicals resulted in the images being non-permanent. Permanence in silver prints was a major issue. Over a relatively short period of time they would fade. Ponton's 1839 discovery that dichromated gelatin is light sensitive was a key point in this chronology as it enabled the development of other processes. Some of the processes that it inspired are continuous-tone processes such as the Carbon process (Poitevin, 1855), Collotype, Photogravure and the Woodburytype (Woodbury, 1864).

The problem of permanence was first resolved photographically by Poitevin's Carbon process and later mechanically by Woodburytype printing. Around the same time that the Carbon process was being developed, Fox Talbot in 1852 was describing his half-tone pattern. This was a method of translating an image using ruled glass screens and meshes into a series of dots that are placed in various sizes side by side ^[33] allowing for the image to be printed with traditional printers ink.

These historical developments were instrumental to the development of the print industry today. At this stage in history the print industry had to decide a commercial route to develop further, whether commercially produced images would be generated as continuous-tone or as half-toned prints. Ultimately it was the half-tone screening process that superseded the other methods. It became the main method of producing photoengraved printing plates.

This chapter assesses the development of the process in an attempt to understand why it quickly became one of the most popular methods of producing photographic imagery but also as to why it fell out of popular use. It concludes with a simplified description of the Woodburytype process is presented which will provide the base knowledge required for when the process is explained in detail in Chapter 4.

1.4.5 Chapter 4 - Gaining base knowledge through the reassessment of the Woodburytype process

Examine the complete workings of the Woodburytype process through the collation and assessment of the historical literature review. The findings are listed as a complete working process alongside the observations gathered throughout the empirical

33 NADEAU, L., Encyclopedia of printing, photographic, and photomechanical processes: a comprehensive reference to reproduction technologies, containing invaluable information on over 1500 processes. Fredericton, N.B., Canada : L. Nadeau, c1989-c1990.

re-assessment of the process. Functioning recipes, technical details and procedural specification will be presented in Appendix 4. Unlike other historical investigations into the Woodburytype this research re-created the process through more than one model and recorded every stage visually to generate a better understanding and working knowledge of the process for this and future research.

1.4.6 Chapter 5 - Contemporary knowledge of digital print technology and testing methods

Chapter 5 covers current digital technologies. It introduces the component parts of a digital image and how they are used within this research to generate a 3D model from which the semi-continuous tone printing plates developed through this research are manufactured. The additive (3D printing) and subtractive (CNC milling) manufacturing processes used to produce the plates are explored and discussed.

This chapter examines the relevant aspects of colour theory and what is needed for a printing process to be accurate. This chapter reviews qualitative elements that had previously been identified such as colour accuracy and fidelity so that quantitative benchmarks can be measured within the new printing method. By reviewing scientific literature on the limitations of the human visual system it presents a discussion on the technology threshold where information is lost when viewed by a human observer.

It highlights why standard quality test methods are unsuitable for determining quality metrics within this study. It presents a new method for relief pigment mixing grounded in colour theory which had to be developed for use within this research's printing model. It addresses repeatability testing within the International Standards Organization (ISO) and why these methods may be uncontrollable for processes as a whole.

1.4.7 Chapter 6 - Printed results of the new method for the reproduction in continuous tone of digitally presented artworks

Chapter 6 presents the main contribution to new knowledge within this thesis. It showcases the evolution of the new printing process and how it was developed from a monotone print to a duotone, and from a duotone to a tri-tone print with the ability to go to full colour and beyond four colour separation. It aims to show how this new method of colour translation from a digital file to a printing plate can be used to print images and control the physical height of the relief contained within the ink deposit. It will present representation of the actual print and microscope captures of the photographic images printed with this method. In doing so it will provide evidence that there is no cellular reticulation or half-tone structure within prints produced through this new method of digital print production but only pigment suspended in relief.

1.4.8 Chapter 7 - Conclusions

Chapter 7 draws the conclusions from the research findings . It outlines possible areas for further research into the subject through with 3D printing technology and further exploration of the potential of artistic printing techniques through painterly deposition of inks.

1.5 My background and position within the Centre for Fine Print Research

I trained in Graphic Product and Interactive Design (GPI). I have a commercial background in graphic design and printing. I had always worked in the design and print industry and I quickly found that I was fascinated with process, procedure and the cause and effect within workflows; in particular the specific stages within design, print and print finishing.

1.5.1 Could CAD/CAM reintroduce qualities from 19th century monochromatic processes but render them in colour?

It is apparent to the researcher that some of the problems that were prevalent at the end of the 19th century and at the turn of the 20th century are still relevant issues today even though technology has advanced significantly since then. Some of these problems such as interference patterns are due to the halftoning process in one form or another. Modern digital imaging pipelines can complicate matters more and add additional problems to the image translation such as banding. Other issues such as print permanence are still areas for concern with the conservation of prints. These are not new problems yet they still exist in some form with current digital inkjet print technologies. It is suggested by the researcher and others that in the development of printing technologies and the resulting evolution of artistic print other methods may have been more suitable for artistic expression. Some of these continuous tone printing methods are capable of photographic rendition of tones by applying pigment as a subtle surface relief, a quality that is lost with the homogenous output of current 2D inkjet printers.

1.6 Previous Research

This thesis builds on previous work undertaken at the Centre for Fine Print Research (CFPR) and continues to challenge the methods of half-tone image translation using continuous tone printing in a contemporary context. This research aims to discover new paths and indicate direction for further research.

1.6.1 **Print research at the University of the West of England and the Centre for Fine Print Research.**

There are three past research projects by the CFPR specific to the generation of this PhD thesis, Thirkell, Huson and Atkinson. All three methods use digital technology dependent on resolution to generate a semi-continuous tone image.

1.6.2 **Paul Thirkell**

Thirkell (2000)^[34] concentrated on practice led research methods that developed an approach with focus on the integration of digital technologies to traditional collotype printing. Thirkell's research covers the basics of photomechanical printmaking and concentrates more closely on the theoretical aspects of why continuous tone is more important as an indicative direction when creating prints from an artistic user perspective. His body of work undertakes a series of practical experiments from a practitioner perspective with a particular emphasis on collotype and the generation of digital negatives in the production of collotype printing plates.

1.6.3 **David Huson**

Huson (2004) along with Thirkell engaged in a practice led research project that focused on the integration of digital technologies and the ceramic portrait tiles originally developed by George Cartlidge (1916). Huson's research generates portrait tiles by utilising subtractive manufacturing process through a CAD/CAM pipeline to machine a bas-relief photographic tile that is CNC milled. As the tile is glazed, the glaze fills into the recess that was created by the CNC milling. Upon firing, the image is created through the thickness of the glaze.

1.6.4 **Andrew Atkinson**

Atkinson (2005)^[35] engaged in practice led research methods that integrated digital technologies and the Woodburytype printing process. It was specifically for the generation of photographic fine art prints. Atkinson's research takes the points raised by Thirkell, that photographic negatives needed for contact printing no longer needed to be created through a photographic exposure, but can be digitally generated and printed to the required size. Atkinson looks at how digital negatives can be output for another screenless photomechanical process, the Woodburytype. Atkinson further develops the CAD/CAM methods of Huson and Thirkell in the digital manufacturing of ceramic portrait tiles through a series of practical experiments to enable the creation of a digitally produced Woodburytype printing plates by CNC milling the matrix, thus removing the need for photographic negatives and contact printing altogether, making

34 THIRKELL, P., 2000. The integration of digitally mediated imaging techniques with 19th century continuous tone printing processes Paul Thirkell, University of the West of England.

35 ATKINSON, A., 2005. THE CREATION OF DIGITAL PHOTOGRAPHIC FINE ART PRINT THROUGH THE WOODBURYTYPE MODEL, University of the West of England.

the process completely digital. While addressing the practical experiments Atkinson focuses heavily on the theoretical aspects of “photographic truths” asking if you can believe the images that a camera produces as being a truthful representation of the world. The processes that Atkinson looked at were used to document, so the concept of producing entirely digitally produced images was a new concept for this particular photographic and printing practice, all the while discussing editing techniques in both traditional ‘wet’ and modern ‘digital’ photographic practices. While generating a model for outputting digital Woodburytypes, historical references to the traditional Woodburytype process are made throughout his research. Atkinson was prevented from recreating the traditional Woodburytype process. As stated in his thesis, it was due to the lack of access and availability of a hydraulic press powerful enough to make the lead printing plates. In this doctoral study the researcher was able to complete the process in its entirety from photographic negative, printing plate production and the printed image.

All examples mentioned from the CFPR involve the re-integration of screenless photographic image generation through digital semi-continuous^[36] tone outputs (See 1.8.6). The outputs from Huson and Atkinson are of particular interest to this new research question, as the tonality achieved in their screenless images is generated by varying the surface topology of the print through a varying relief of pigment deposition.

The research question within this thesis extends the work of Atkinson’s monochromatic approach so that screenless images can be digitally output as polychromatic photographic images while advancing methodological approaches for future research. This research further extends the understanding of the Woodburytype through additional research into historical photographic and print accounts and establishes working methods of multiple iterations of the process some 85 years after it became redundant and left in a dormant state.

36 Semi-continuous tone is explained on page 22.

1.7 Baselines and assumptions within the research

To avoid assumptions a baseline knowledge of printing is needed in understanding this thesis. Quite often in photography and printing, terminology is borrowed from one to another and vice versa. This can include the same or similar terminology being used in both the non-digital and digital equivalent. This can sometimes lead to confusion and is something the reader should be aware of. Any ambiguous terminology used within this thesis will be highlighted and explained in the relevant context to avoid any confusion that may arise.

Throughout this thesis the terms, continuous-tone and half-tone will be used. There are various spellings of the words in different formats. Separate words “continuous tone or half tone”, hyphenated words “continuous-tone or half-tone” and abbreviated and compound words “contone or halftone”. Some authors differentiate between the terms where some variants are used to describe the human visual system (HVS), photographic terminology, the image translation process required for printing and finally the printing process itself that is employed by the printer (both the occupation and machine). When directly quoting an author, the spellings of these words may change from this researcher’s use in the main thesis body text. It can be confusing, so the reader must be aware of this. For clarity, in this research unless quoting an author directly the terminology used will be the hyphenated variants – “continuous-tone and half-tone” and the term “colour” will be used unless quoting an author using the alternative ‘international’ variant.

1.8 Printing terminology

Specific print terminology is used in this thesis from the outset. In order to highlight previous studies that have influenced this doctoral study, some terminology must be explained in order to understand it. These definitions and explanations include; a method of printing using a specific kind of printing plate - intaglio; two well known print genres continuous-tone and half-tone are discussed; a lesser known printing sub-genre known photoplastographic and finally a term generated for this study that will be known throughout as semi continuous-tone. I will now identify and describe these core terms.

1.8.1 What is a print?

A print is the end result of one of the most widespread artistic practices, it is by its most basic definition “a picture or design made from an inked impression of an engraved metal plate, wooden block, lithographic stone.”^[37] It is simply a method of transferring an image from a matrix (printing plate or digital print file) to a substrate (material onto which you print) by means of a pigmented medium (ink).

Today prints normally fall into two categories, commercial and artistic. Artistic prints can be described slightly differently as follows: “A print is a work of art that is made by transferring an image from an inked surface to a sheet of paper and that exists as one of multiple impressions, which together constitute an edition.”^[38]

1.8.2 Intaglio Printing

The term intaglio comes from the Italian verb intagliare, meaning “to carve”,^[39] and it is a blanket term for a range of printing techniques. In intaglio, concavities below the surface of the printing plate hold the ink. The grooves are either manually cut, impressed, or chemically etched into the plate. The thickness and depth of the grooves can vary meaning that the ink can be transferred to the paper in different sizes and intensity. Prints produced earlier in the edition tend to be stronger, darker and with more fine detail. Prints produced later in the edition can appear less intense and with less detail as the printing plates become worn due to the nature of the printing process.^[40]

³⁷ OXFORD ENGLISH DICTIONARY, , Definition of print Homepage of Oxford English Dictionary, Online. Available: <http://www.oed.com/view/Entry/151479?rskey=5vi38j&result=1&isAdvanced=false#eid> April 19th, 2013.

³⁸ SUZUKI, S., 2011. What is a print? Selections from the Museum of Modern Art. 1 edn. New York: The Museum of Modern Art.

³⁹ SUZUKI, S., 2011. What is a print? Selections from the Museum of Modern Art. 1 edn. New York: The Museum of Modern Art.

⁴⁰ GASCOIGNE, B., 2004. How to identify prints. A complete guide to manual and mechanical processes from woodcut to inkjet. 2 edn. London: Thames & Hudson.

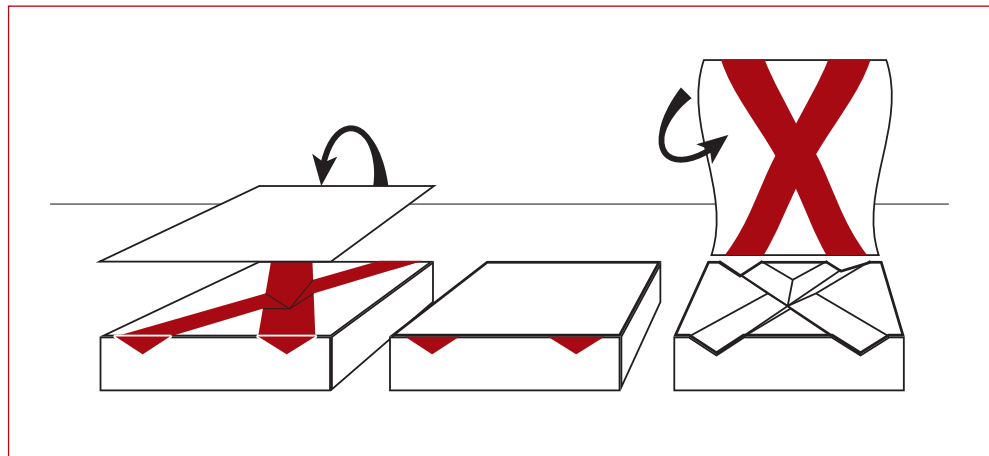

Figure 1.3 Illustration of intaglio printing

Commercial printing had its origins between 206 BC and 221 AD. The Chinese had established a method for creating multiple copies of text by means of printing called woodblock printing (Brown, 2005)^[41]. Woodblock printing translates an image into areas that were inked (black) or not inked (white), and which form the basic principles of binary or half-tone printing.

1.8.3 Continuous-tone and half-tone

A continuous-tone (contone) image is one that contains no grain or structure allowing for smooth gradations from light to dark, such as a photograph.

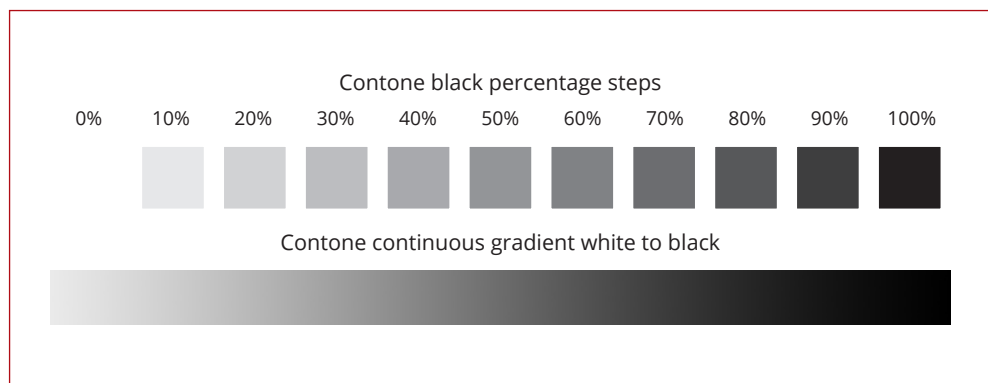

Figure 1.4 Example of continuous tone printing (for demonstration purposes only)

⁴¹ BROWN, A.P., 2005. *Inks for the fine art printmaker: a system and methodology for the development, testing and manufacture of oil-based printing inks for the fine art sector*, University of the West of England.

When a continuous-tone input image needs to be output through a process that is not capable of rendering the tones contained in the original, a translation process needs to take place. This translation process gives the illusion of tonality when printed with this restricted output gamut (colour range). This translation process enables the middle tones (mid-tones) or half-tones as they are also known as to be printed. This process is known as a half-tone translation process or half-tone screening. Half-tone printing processes usually translate the input image into a series of binary lines or dots, ^[42] and either adjusting their sizes, distances apart or a combination of both ^[43]. The terms half-tone screen or half-tone screening should not be confused with serigraphy also known as screenprinting in the UK and silkscreen in the US. Serigraphy is a printing method which utilises the half-tone translation process. Half-toning has been the subject of over 120 years of research and development ^[44].

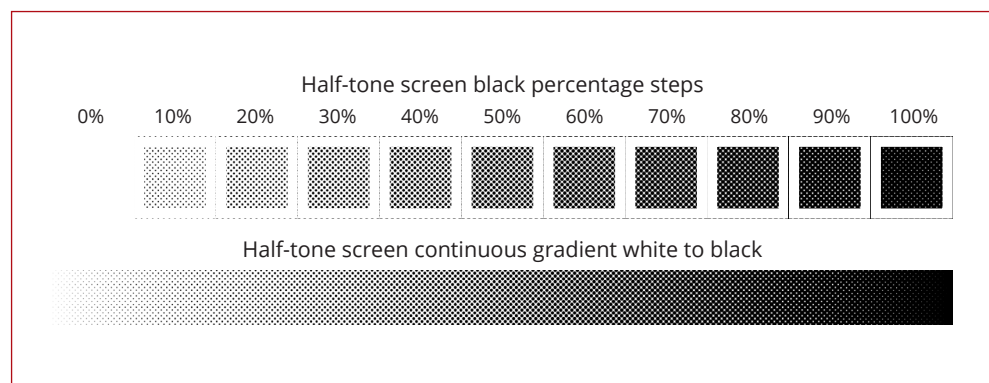

Figure 1.5 Example of half-tone tone printing

More recent definitions are very similar in context, but may include terminology such as digital half-toning. This can be somewhat confusing but the general principal is the same, it is still the conversion of a continuous tone image into an image with a limited number of colours. Digital images need this conversion as the image may be output through devices such as colour printers or viewed on low-bit depth displays. ^[45] With half-toning the goal is the same regardless if digital or non-digital. For the half-tone image to have the illusion of being a continuous tone image, the translation process is reliant on the limitations of the human visual system (HVS). The viewer therefore

⁴² NADEAU, L., Encyclopedia of printing, photographic, and photomechanical processes: a comprehensive reference to reproduction technologies, containing invaluable information on over 1500 processes. Fredericton, N.B., Canada : L. Nadeau, c1989-c1990.

⁴³ TRITTON, K., 1996. Stochastic Screening. Surrey, UK: PIRA International.

⁴⁴ LAU, D.L. and ACE, G., 2008. Modern Digital Halftoning. 2 edn. CRC Press, Taylor & Francis Group.

⁴⁵ BAQAI, F.A., LEE, J., UFUKAGAR, A. and ALLEBACH, J.P., 2005. Digital Color Halftoning. Problems, algorithms, and recent trends. IEEE SIGNAL PROCESSING MAGAZINE, (January), pp. 87

interprets it as having the ‘appearance’ of a continuous tone image as our eyes act as a low pass filter filling in the gaps of information.

1.8.4 Photoplastography

This thesis looks at two processes called the Woodburytype and Carbon process. These processes produce photographic quality images and are categorised into a broad category of printmaking previously described as continuous-tone. Nonetheless, both processes, the Woodburytype and the Carbon process also fall into a smaller specific and lesser-known sub-genus of continuous-tone printing known as photoplastography.

The term photoplastography, in photography, is any process in which a plastic substance changes its form because of the action of light and returns to a thickness suitable for a colored gelatinous ink (Whitney, Smith, 1911)^[46], i.e. Woodburytypes (McDowell Patterson, 1921)^[47]. Prints produced in this manner generate photographic quality tonal gradations through physical relief obtained by printing with a gelatinous printing ink.

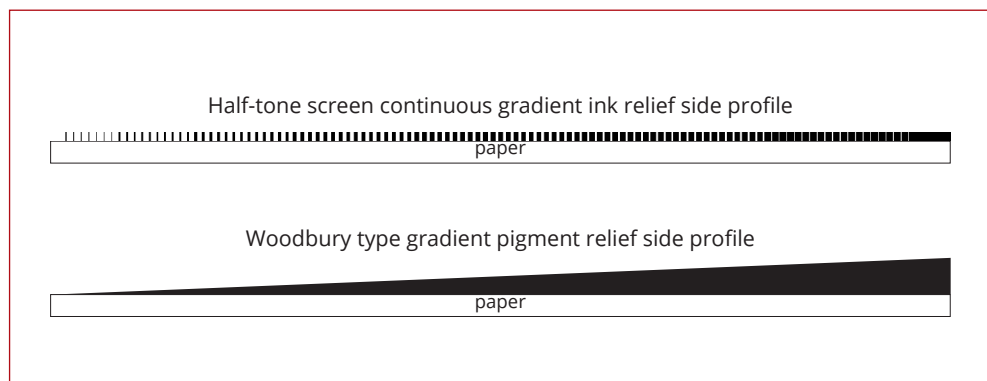

Figure 1.6 Example of continuous tone printing (for demonstration purposes only)

⁴⁶ Whitney, W.D. and Smith, B.E. (1911) *The Century Dictionary and Cyclopedia*. Revised ed. Century Company.

⁴⁷ Mc Dowell Patterson, Austin M (1921) *A French-English Dictionary for Chemists 1876-1956*. illustrated reprint ed. BiblioLife, 2015.

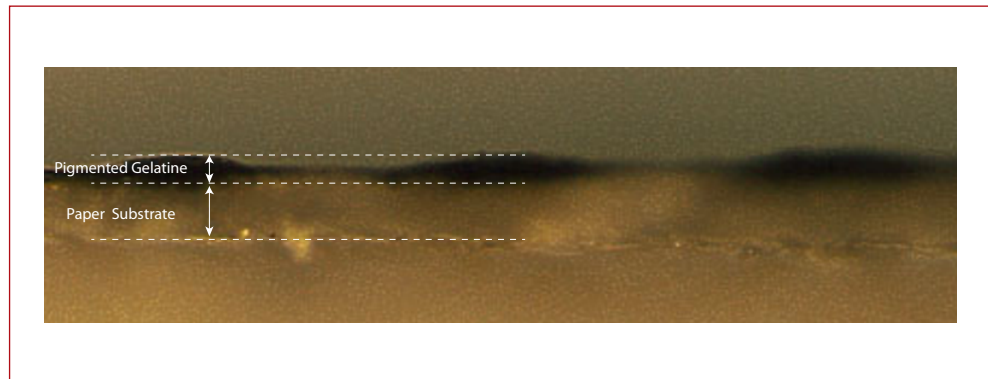

Figure 1.7 Microscopic cross section of a Woodburytype print showing pigment relief.
Image used with permission, Stephen Hoskins, CFPR, UWE Bristol.

1.8.5 New terminology

It was stated previously that terminology in photography and printing often gets borrowed and adapted to suit the classification of new processes. In Chapters 4 through 6 this research project describes new printing processes for the first time and as such have no officially recognised print genus. These new processes are modern variants of traditional photoplastographic processes. New terminology was generated for this thesis by adapting and using existing terms. A table illustrating the new family of processes is shown below and an example mentioned to highlight the context.

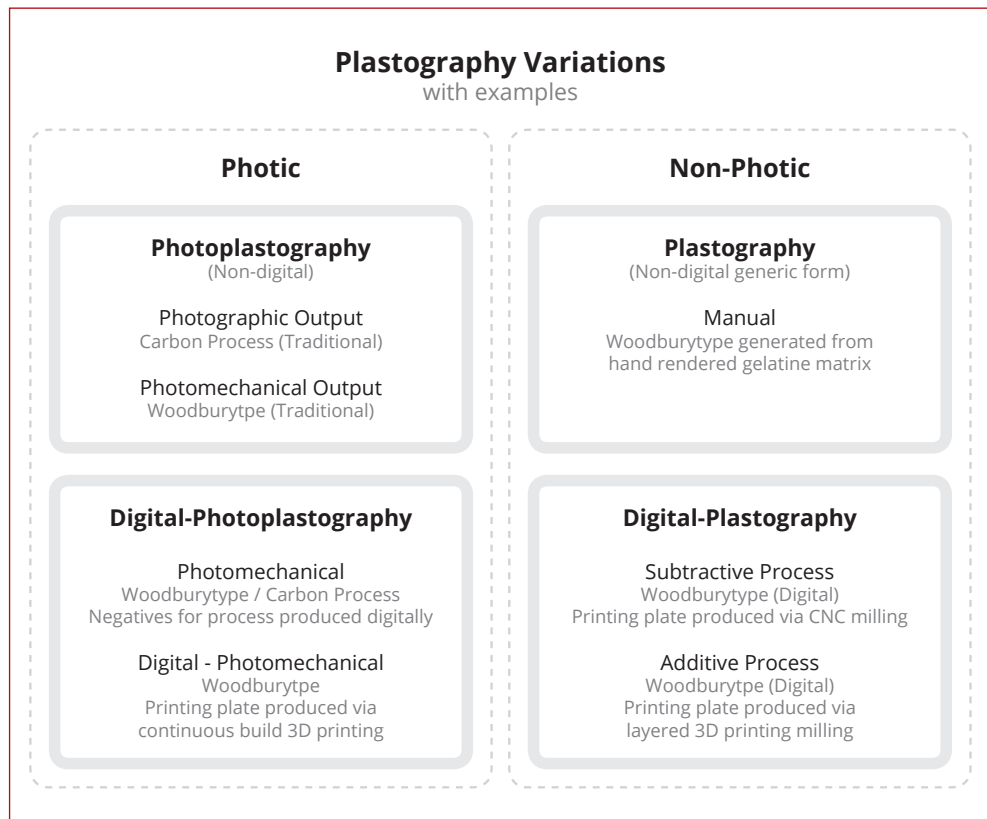

Figure 1.8 Diagram showing plastographic terminology variations within this research

The processes that require a reaction to UV light are 'photic' and as such these processes will be classed as photoplastographic. The processes that require no reaction to UV light are therefore 'non-photic' and as such are termed generically plastographic. In addition to this, if the processes contain a digital element then the hyphenated prefix 'digital' is added. The new process identifying names are: photoplastography, plastography, digital-photoplastography and digital-plastography. The prints from the processes will be described generically as plastographic.

1.8.6 Semi Continuous-tone

Within this thesis is the presentation of results generated from empirical studies. Some of the results that are discussed are from prints produced by printing plates that have been designed to emulate the topographical qualities of the 19th century intaglio processes. Prints taken from these digitally produced printing plates are continuous-tone as they contain no half-tone dot structure in the final print. However the input information needed to produce and digitally manufacture these intaglio-printing plates contains an element of bit-depth (see 5.2.1) and this is then passed onto the final image regardless of output.

This bit depth and resolution dependence, however fine, ultimately reduces the fidelity of the final printed image. The manner in which the printing plate is produced requires a translation stage. This translation reduces the information contained within the source image, for example converting a RAW photographic file to Jpeg. This down-sampling can occur at the start of the digital image file generation. Additional translation stages may also occur that affect the output file and furthermore may reduce fidelity, for example the method of output may also require a reduction of the bit-depth information thus down-sampling the image. Due to this consideration, in this thesis the plastographic prints produced within a digital imaging pipeline are termed semi-continuous-tone. This is because they are produced from a restricted input image and / or output file that has been down-sampled due to a technical limitation within the process.

1.9 Next chapter

In Chapter 2 the methodological approach to this research will be discussed in detail.

2 Methodological Approach

Synopsis: The aim of this methodological chapter is to convey the process of inquiry throughout this doctoral study. It will provide an overview of the methodological approaches that were used to determine the specific methods employed. It will demonstrate the rationale behind the critical thinking into the approach so that data could be collected and critically assessed.

“There is no single pathway to good research: there are always options and alternatives. At any stage of any enquiry, researchers need to take decisions, make judgements and use discretion in order to successfully complete a project.” ^[1]

MARTYN DENSCOMBE

2.1 Introduction

Methodologies are best achieved by comparatively assessing the possible approaches and selecting the most appropriate methods through an informed choice (Gray, Malins, 2004).^[2] While the scope of discipline that research doctorates fall under are broad, several descriptors define them into a handful of specific key identifiers or doctoral descriptors. All of which include a description of what is a methodological approach. Phillips and Hughes state that you must have mastery of appropriate techniques that are currently being used, and also be aware of their limitations within the confines of research (Phillips, Pugh, 2010).^[3] The Quality Assurance Agency for Higher Education (QAA) in the UK adds to this that a doctoral methodological approach must show a detailed understanding of applicable techniques for research and advanced academic enquiry (QAA, 2011).^[4] Archer adds that the critical appraisal of prior research and

¹ Denscombe, M. (2010) *The Good Research Guide: For Small-Scale Social Research Projects*. 4th ed. UK: Open University Press.

² GRAY, C. and MALINS, J., 2004. *Visualizing Research. A Guide to the Research Process in Art and Design*. Ashgate Publishing Limited.

³ PHILLIPS, E.M. and PUGH, DEREK S. 2010 *How to get a PhD: a handbook for students and their supervisors*. Open University Press.

⁴ THE QUALITY ASSURANCE AGENCY FOR HIGHER EDUCATION, 2011. *The UK Doctorate*.

close attention to the principles and practice of research methodology are necessary (Archer 1995). ^[5]

The Vitae Researcher Development framework (RDF) (2010) ^[6] categorises all of these doctoral descriptors within a series of domains represented as the four quadrants in figure 2.1 below. This framework demonstrates the total criteria needed to complete a doctoral study in the UK.

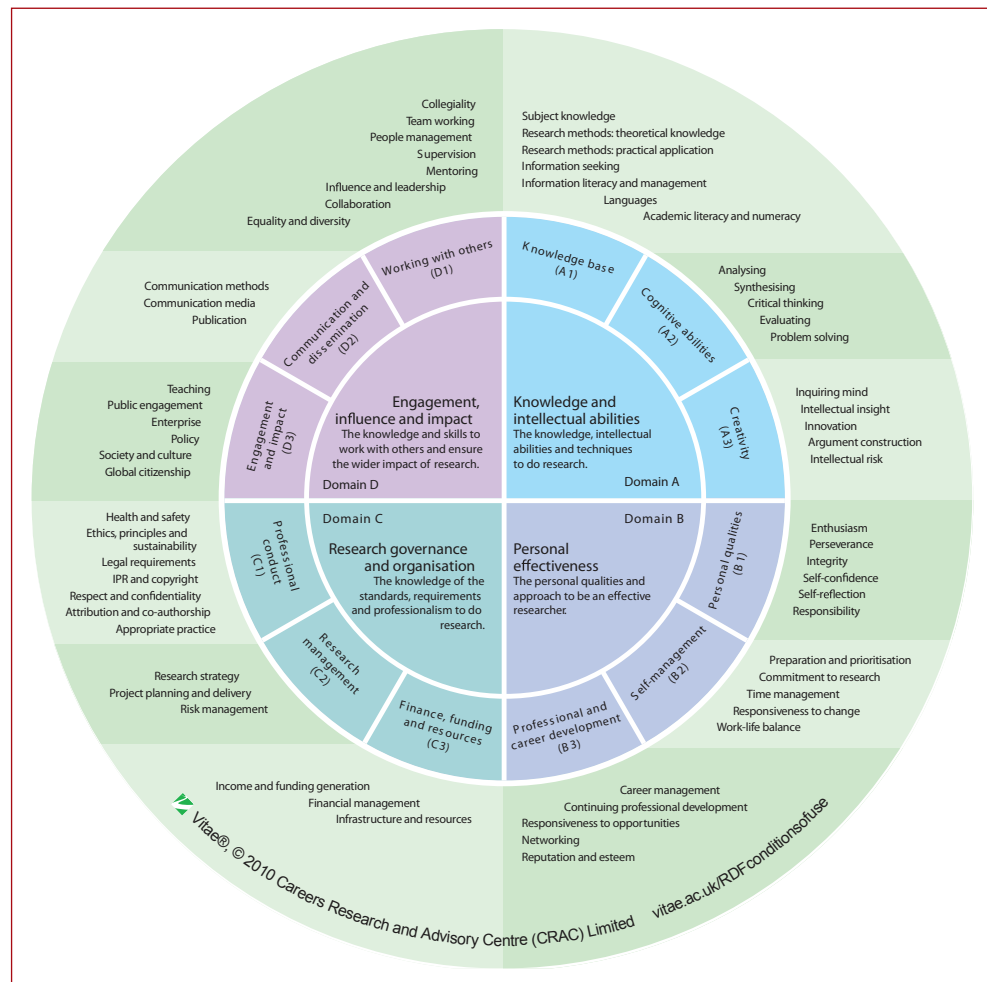

Figure 2.1 Vitae Researcher Development Framework (www.vitae.ac.uk/rdf).

The RDF framework gives a set of measurable and assessable outcomes which are essential for doctoral students and for professional researchers. The methodological

5 ARCHER, B., 1995. The Nature of Design. Co-Design. Interdisciplinary journal of design, (January), pp. 6-13

6 VITAE, 2010. Introducing the Researcher Development Framework. Vitae, Careers Research and Advisory Centre.

approach taken in this doctoral research falls under Domain A of the Vitae Doctoral Descriptor as part of the Researcher Development Framework (RDF),

2.2 Knowledge and intellectual abilities

This chapter will demonstrate the knowledge, intellectual abilities and techniques that were employed to complete this doctoral research study. The terms 'methodology' and 'method' are often confused and mistakenly used interchangeably. They are not the same thing. The method is an element of the methodology as a whole as the definitions below state

Method, *n.*

- The principles or procedures of any mode or field of cognitive activity, themselves considered as an object or branch of study;
- A special form of procedure or characteristic set of procedures employed (more or less systematically) in an intellectual discipline or field of study as a mode of investigation and inquiry, or of teaching and exposition;
- **Philos.** Any of various principles or canons of inductive reasoning used by scientists in searching for or testing causal laws, esp. the general principles of experimental inquiry discussed in J. S. Mill's *Syst. Logic* (1843). (Oxford English Dictionary Online, 2001). ^[7]

Methodology, *n.*

- **Originally:** the branch of knowledge that deals with method generally or with the methods of a particular discipline or field of study;
- **Arch:** a treatise or dissertation on method;
- **Bot:** systematic classification;
- **Obs.** rare: Subsequently also: the study of the direction and implications of empirical research, or of the suitability of the techniques employed in it;
- **More generally:** a method or body of methods used in a particular field of study or activity. (Oxford English Dictionary Online, 2001). ^[8]

2.2.1 Methodological approach

There is no clear consensus about how research into art and design disciplines should

⁷ Oxford English Dictionary (2001) Method. Available from: <http://www.oed.com/view/Entry/117560?rskey=Pcmncl&result=1#eid> Accessed 27/05/2016.

⁸ Oxford English Dictionary (2001) Methodology. Available from: <http://www.oed.com/view/Entry/117578?redirectedFrom=Methodology&> Accessed 27/05/2016.

be undertaken according to Newbury (1996). He states that research itself is an integral part of the art and design process and suggests that the best research approach into the creative disciplines is one that it spans the logical and analytical, in combination with the subjective and idiosyncratic. He argues that by separating theory from artistic practice in research, the academic institutions are creating a divide that is ultimately damaging the successful development of art and design research.^[9] Making the most appropriate methodological choices is vital in producing sufficient data needed for evidence to develop and conclude a convincing academic argument. Toulmin (2003) developed a model of a structure for academic argument^[10] consisting of four components:

Claim	an arguable statement.
Evidence	data used to support the claim.
Warrant	an expectation that provides the link between the evidence and claim.
Backing	context and assumptions used to support the validity of the warrant and evidence.

The methodology of the research is inextricably linked to the evidencing, warranting and backing for the initial claim.

2.2.3 Research for art approaches

Herbert Read (1958)^[11] wrote that Art Education research fell neatly into three distinct but individual categories; research into art and design, research through art and design, and research for art and design. The definitions of Read's categories are as follows, Research into art and design examines historical research, aesthetic or perceptual research; the theoretical; social; material and technical issues that arise. Research through art and design is embodied as materials research, developmental work and action. Research for art is concerned in using background research to produce a work of art or an artefact where the artwork is the final contribution.

Frayling (1993) later adapted and expanded upon these distinctions stating that Read was limiting their scope by restricting them to one category or another.^[12] Frayling felt they worked more efficiently when combined as a multiple approach to research in creative disciplines. This mixed method approach appears to be common place within research into the arts or creative disciplines.

9 NEWBURY, D., 1996. Knowledge and research in art and design. *Design Studies*, 17, pp. 215-219

10 Toulmin, S.E. (2003) *The Uses of Argument*. 2nd ed. Cambridge University Press.

11 Read, H. (1958) *Education through Art*. 3rd ed. Faber & Faber.

12 FRAYLING, C., 1993. *Research in Art and Design*.

2.3 Methodological models and methods used to conduct the research

There was no single methodological approach upon which to undertake the research. A mixed method approach was deemed the best strategy. In the simplest form a mixed method approach is one that takes a qualitative and quantitative approach. However as this body of research is firmly in the arts large portions of the outcomes are subjective in nature. The research consisted mainly of two component parts – theory and practical investigation. Continuing with Read’s categories my approach in generating the research can be described as a combination of the first two components, research into and through art and design. Which leaves the third distinction, research for art and design as a possible outcome for post-doctoral research.

2.3.1 Research into ‘print’

Historical theoretical analysis was undertaken to gain knowledge of an obsolete photographic and printing process that was once heralded as the most beautiful process ever invented. Research into the contemporary derivations of the Woodburytype process through digital methods were also analysed.

2.3.2 Research through ‘print’

Empirical testing of the historical knowledge was then tested with modern materials to see if a contemporary method could be developed with the aim of leaving a working model for others to follow. An analysis of digital Woodburytype methods was undertaken for the verification of contemporary methods. Component areas of these studies were verified through repeat testing and analysis. Contemporary methods of analysing and gaining quantitative data from prints were designed purely for flat artwork. This also led to the development of hybrid testing methods.

2.3.3 Research for ‘print’

The nature of the research is practice led, resulting in new knowledge from a large historical background with empirical and action research producing a functioning model, but without presenting the findings as a creative outcome. The overarching goal of this research is not to produce artistic printed outcomes but an alternative vein of continuing print development parallel to the halftone process.

2.4 Methods of conducting the literature review and historical documents sources

The initial research method was to perform a critical analytical review of the current literature in the field. The approaches and paradigms that were employed were assessed for their appropriateness, the techniques they used and the results that they obtained. Several difficulties were anticipated from this review. The identification and isolation of these difficulties have allowed me to generate a reliable methodological

approach that provides me with the data required to complete the research. There has been little contemporary writing on the Woodburytype as a complete functioning process since the process' partial obsolescence. There have been even fewer commentaries on plastographic printing techniques which constitutes the core printing genus of this study. Remnants of Woodburytype printing equipment used in the 19th century are sparse and not all located at one site. Quite often they are in museums and not all are in working order. This makes it impractical and expensive to fully assess the mechanical elements of the Woodburytype process through the original equipment. The main body of work conducted in the first section of this research is theoretical due to this issue. It relies on documentation that already exists. Public and academic demonstrations of the Woodburytype are a rarity so witnessing the process in action is nearly an impossibility. There are videos which demonstrate the process but again I would challenge these demonstrations as they are not technically accurate and they do not show the process in its entirety often focusing on the final stages involving the 'pulling of a print'. This is discussed more in Chapter 3 and Chapter 4 and the findings of this literature review is presented in Appendix 4.

The information that was obtained and accessed in this literature survey was a combination of primary and secondary sources. The primary sources included are articles and letters that were published by the inventor of the process, along with his accounts of the process, and patents. A selection of Woodburytypes were viewed at the the Royal Photographic Society where they had volumes of the "Photographic Journal" in their archive that included original Woodburytypes. Others were presented at exhibitions and from private collections. Modern publications describing the process often represent the Woodburytype prints as halftone reproductions which destroy the continuous tone qualities of the originals, and as such are not good representations of the print quality. They are useful in assessing the subject matter of the print but not much else as the image would have been digitally edited pre-press. The issue of viewing halftone reproductions can be avoided by viewing original artefacts. The Woodburytypes that were observed were in a very good condition that allowed for a visual assessment.

Secondary information was contained in the form of published and written eyewitness accounts, historical descriptions of the details and of the process by people who have not re-enacted it.

2.4.1 Archival visits, on-line digital archives and on-line communities

Many archives and journal databases are now available digitally. This allows the researcher to access previously restricted journals, articles and theses from anywhere in the world at any time of day. The documents are generally available to download in PDF format allowing them to be viewed on a multitude of digital display devices

or printed in hard-copy format (where restrictions have not been placed on the digital file's usage). During this doctoral study some digital archives became available making information gathering much more expedient and efficient in terms of time and the resources needed to view the articles. Digitised historical journals tend to be optimised with Optical Character Recognition (OCR) allowing for functioning word and phrasing searches. This can make it more expedient to locate articles. Historical journals that were printed through the letterpress printing process can be troublesome for OCR. The kerning and leading^{[13]*} for some of the letter shapes make it difficult for some words to be identified, and therefore can go unmissed unless read by a human observer. This is not an issue for modern digitally typeset documents. While it may make it quicker to identify articles that contain key words or phrases, it is not appropriate to do a "catch all" blanket search within data bases. Terminology used within the print industry and in digital imaging technology is applicable to many disciplines including physics, biology, and the computer sciences. The context of the article cannot be identified until it is viewed and such a wide search will produce many misleading paths to follow as a researcher. The criteria for digital database searching must be considered along with specific key terminology and subject specific identifiers.

2.4.2 The British Library

Articles that were identified as being essential reading (through the cross referencing of bibliographies) were requested from the British Library. ^[14] The digitising of journals and newspapers in the British Library acts as conservation process. Fragile documents such as the journals containing information on the Woodburytype process once digitised are removed from public access in the reading rooms and can only be viewed through the digital versions.

2.4.3 E-Theses On-line services (ETHOS)

ETHOS ^[15] provides access to over 400,000 doctoral theses that are available instantly to download in PDF format. Theses that are not available digitally can be requested through this service where they can be sent to institutional libraries or digitised.

2.4.4 Library of Congress

Several American photographic journals unavailable through the British Library were available through the Library of Congress ^[16] in the form of downloadable PDFs.

¹³ * The kern is a feature of a typeset character that extends beyond its bounding box. This allows these features to slightly overlap the characters set next to them, creating a more natural spacing between the two. The leading is the distance, measured in points, from the top of one line of type to the baseline of the line that precedes it. (Felici 2003)

¹⁴ British Library British Library. Available from: <http://www.bl.uk> Accessed 27 May 2016.

¹⁵ British Library E-Theses Online Service (ETHOS). Available from: <http://ethos.bl.uk/Home.do> Accessed 27 May 2016.

¹⁶ Library of Congress Library of Congress. Available from: <https://www.loc.gov> Accessed 27 May 2016.

2.4.5 Royal Photographic Society

The Royal Photographic Society's (RPS) journal is the longest continually running photographic periodical in the world from March 1853 to present day. The Photographic Journal (PJ), (now published as 'The RPS Journal') was initially accessed by visiting the RPS offices in Bath (UK). I was given access to a set of Journals from the 1853 through the 20th century. Throughout the later part of this research study the RPS completed a digital archival of the journals from 1853 to 2012. ^[17] These were made publically available just before this thesis was written. Many of the articles printed in the mid 1900s that contained a positive search match were simply re-prints of articles from the 1800s. While this may seem fruitless it actually indicated a point in history when original articles on the Woodburytype process ceased to be published.

2.4.6 The Photographic Society of London, and its publication The Photographic Journal.

Later The Royal Photographic Society (John Hannavy, 2008) ^[18]

2.4.7 British Journal of Photography

The The British Journal of Photography (BjOP) contains many technical articles and documents regarding the workings of the Woodburytype. During the course of this research, the publisher of the BjOP '*Apptitude Media Ltd*' has announced that it is digitising the journals from 1854 – 2005 into an accessible database. At present it is available through ProQuest to colleges, universities and subscribers. ^[19] The disadvantage of this is at present the database is incomplete and was unavailable for a wider literature review rendering the resource impractical. It will however be a massive resource for further researchers in this field when it is fully functional.

Initially it began as Liverpool Photographic Journal on 14 January 1854 and continued through to December 1856 (vols 1–3). The name changed to the Liverpool & Manchester Photographic Journal from January 1857 to December 1858 (vols 4–5). After this date the name changed to the Photographic Journal from January to December 1859 (vol 6) and finally known as The British Journal of Photography from January 1860 (vol 7) to the present day. The British Journal of Photography was able to disseminate more information with national and international contributors due to separate Colonial and Overseas editions (Michael Hallett, 2008) ^[20]

¹⁷ Royal Photographic Society The RPS Journals. Available from: <http://archive.rps.org> Accessed 27 May 2016.

¹⁸ Hannavy, J., ed. (2008) Encyclopedia of Nineteenth-Century Photography. 1st ed. USA: Routledge.

¹⁹ British Journal of Photography British Journal of Photography (1854-2005). Available from: <http://www.proquest.com/products-services/artarcharc.html> Accessed 27 May 2016.

²⁰ Hannavy, J., ed. (2008) Encyclopedia of Nineteenth-Century Photography. 1st ed. USA: Routledge.

2.4.8 The Photographic News (1858-1908) & The Yearbook of Photography and Photographic News Almanac

The Photographic News was an important source of technical instruction and improvements to photographic processes for this research. The publication was lauded for its critical reviews of literature and exhibitions including reports from photographic societies throughout Europe. (John Plunkett, 2008) ^[21]

2.4.9 Centre for Fine Print Research Woodburytype Archive

The CFPR has a comprehensive collection of Woodburytype prints, and articles on the process within its Woodburytype Archive. ^[22]

There were quite a few publications and journals that it did not reference such as the “Photographic Journal”. Identifying this gap in historical knowledge directed me to investigate the articles from the PJ and make contact with the RPS. The Photographic News (PN) and the BJoP make up a substantial portion of the CFPR’s database.

2.4.10 Open source databases – Google Scholar

Google Scholar ^[23] is becoming a very accessible source of historical journals due to copyright expiration and the IP of publications becoming public domain. Older educational institutions and academic libraries are digitising their copies of pre 1900 texts and making them publically available through this outlet.

2.4.11 British Newspaper Archives

These archives ^[24] contain no practical information on the process but they offer a social insight on how the Woodburytype process was announced outside of the photographic circles and explained to the wider public. They also provide various interesting obituary notices on the death of the process’ inventor Walter Bentley Woodbury and the circumstances around it.

2.4.12 Intellectual Property Office (IPO)– Searchable Patents Journal

The Intellectual Property (IP) within patents is available from the IPO. ^[25] Some patents were available in the form of downloadable PDFs. However not all of the patents could be accessed due to issues relating to when the digital archives started and that most of the original patents used a different numbering system no longer in use or were no longer available.

²¹ Hannavy, J., ed. (2008) Encyclopedia of Nineteenth-Century Photography. 1st ed. USA: Routledge.

²² Centre for Fine Print Research Woodburytype Archive. Available from: <http://www.uwe.ac.uk/sca/research/cfpr/dissemination/archives/woodburytype.html> Accessed 27 May 2016.

²³ Google Google Scholar. Available from: <https://scholar.google.co.uk> Accessed 27 May 2016.

²⁴ British Library, f. The British Newspaper Archive. Available from: <http://www.britishnewspaperarchive.co.uk> Accessed 27 May 2016.

²⁵ UK Government Intellectual Property Office. Searchable Patents Journal. Available from: <https://www.ipo.gov.uk/p-pj> Accessed 27 May 2016.

2.4.13 St Brides Photographic Library (London)

St Brides Photographic Library London was identified as a potential resource. However it was not visited for this research. It was referenced in other research methodologies relating to the Woodburytype process. The articles that were used were listed in the bibliographies and were obtained for this study through various digital archives and document copy requests through the British Library. This allowed for the reading of fragile documents without travelling to London to visit the library personally. This was a considered decision as the articles were written pre-1900 and no new work was added to the publications.

2.4.14 Contemporary Literature Review

There have been very few contemporary writings on the Woodburytype process in the 21st century. Most writings on the subject tend to be information collected from historical journals without any new contribution on the subject. A select few modern authors have provided a valuable insight in the process as they not only have historically documented the process but recreated the process in part or entirety through traditional or modern processes.

2.4.15 Nicolai Klimaszewski (1994)

Klimaszewski^[26] developed a method of generating Woodburytype printing plates through subtractive manufacturing using CNC cutting tools. This appears to be the earliest mention of a contemporary practitioner using digital technology to develop a functioning process.

2.4.16 Andrew Atkinson (2005)

Atkinson's Thesis (2005) gives a detailed insight into the Woodburytype process, however it also presented several areas to recreate and test his observations. Detailed accounts were given and enough information is available in it to test parts of the process. Atkinson was unable to recreate the traditional Woodburytype process in its entirety due to technical limitations. He followed on with a method similar to Klimaszewski's CNC method and developed an additional digital method using polymer plates.

2.4.17 Barret Oliver (2006)

Barret Oliver is possibly the foremost authority on the Woodburytype process today having published the History of the Woodburytype.^[27] This publication gives an account of the Woodburytype but no functioning details as how to recreate the process. It contains halftone reproductions of Woodburytype prints, and is printed on a paper stock that does nothing to improve their quality.

²⁶ Klimaszewski, N. Nicolai Klimaszewski. Photography / Printmaking / Sculpture. Available from: <http://www.klimko.com> Accessed 27 May 2016.

²⁷ Barret, O. (2007) A History of the Woodburytype. 1st ed. Nevada City, California: Carl Mautz publishing.

2.4.18 RPS & Alan Elliott (2008)

The RPS published Walter Woodbury, A Victorian Study in 2008. ^[28] This historical account retraces Walter Bentley Woodbury's time in Australia and Java. It mostly follows the social settings leading up to the invention of the Woodburytype. In it they give an abbreviated description of the Woodburytype and give accounts of their attempts to recreate it. They do not give their recipe for the method. They mention the difficulties in creating Woodburytypes in a hot climate and state the reasons as to why the Woodburytype failed in Australia as a popular process. Through the RPS and this publication I came into contact with Alan Elliott, one of the authors of the book.

2.4.19 Chuck Close (2012)

The artist Chuck Close worked with Barret Oliver in 2012 on a series of Woodburytype prints produced at Two Palms Press ^[29]. The prints were then exhibited in the USA 2012. The project was included in a revised edition of Chuck Close Prints: Process and Collaboration. ^[30] It includes an interview with Close and Oliver where they describe their feelings on the process and the equipment they use. Some of the comments I would challenge and disagree with later in this thesis. It contains several photographs of Oliver working on various stages of the process showing the equipment he used.

2.4.20 Factum-Arte (2016)

Factum-Arte ^[31] came to my attention too late in the research project to make contact with (in the final few months of completing this thesis). Of the contemporary practitioners of the Woodburytype process it seems that Factum-Arte have the most in common with my interest in the process and how to develop it further through the advancement of technology. This could be an area of further collaboration and research.

2.4.21 Empirical Observation of Process

Where possible in this research if technical demonstrations were available on historical process that were directly or indirectly involved with the Woodburytype process they were attended and observed. This occurred in the instances where a practical overview deemed beneficial yet it would have been impractical to learn the process to a proficient level of expertise.

28 The Royal Photographic Society, Victorian Chapter (2008) Walter Woodbury. A Victorian Study. 1st ed. Melbourne, Australia: RPS Victorian Chapter.

29 Close, C. Chuck Close. Two Palms Studios, New York 2012. Available from: <http://www.twopalms.us/artists/chuck-close>

30 Sultan, T. (2014) Chuck Close Prints: Process and Collaboration. 1st ed. Prestel Verlag.

31 Factum-Arte Woodburytype Prints: Redeveloping a 19th Century Print Process. Available from: <http://www.factum-arte.com/pag/731/-span--span-Woodburytype--span---span--Prints---br--Redeveloping-a-19th-century-print-process> Accessed 27 May 2016.

2.4.22 Carbon Transfer Process Workshop

The closest process relating to the Woodburytype is the photographic carbon transfer process. An intensive one on one workshop over three days was attended to gain experience with this gelatine photographic processes. The workshop was lead by Dr Peter Moseley, a practioner and expert in 19th century photomechanical processes and the empirical results from the workshop are presented in Appendix 4. The Carbon Transfer Process is identical in theory to the Woodburytype up to a certain point of the process and will be described in the next chapter. There is a large selection of contemporary literature on the topic and many videos demonstrating the stages of the process listed in the bibliography. The knowledge gained from this process leads directly to the empirical tests described in Chapter 4.

2.4.23 Wet plate collodion demonstrations

A series of demonstrations were attended at the “Rethinking early photography”^[32] conference held at the University of Lincoln 16–17 June 2015. Historical and wetplate process photographer Michael Schaaf^[33] gave a practical demonstration and walk-through of the wet plate collodion photographic process. (Photographs of the process can be seen in figure 4.3). This provided valuable insight to the processes leading up to the negative generation of the Woodburytype process. Sadly Michael passed away in the summer of 2016.

2.4.24 Albumen printing workshop

Continuing with the “Rethinking early photography” conference, Schaaf lead a practical workshop on collodion printing techniques including Albumen process. While not directly related to this research it was attended to get a better understanding of the technology and processes involved with photographic contact printing utilised at the time of the Woodburytype’s inception. (The print produced and photographic records can be seen in figure 4.20).

2.4.25 Video Sharing – YouTube and Vimeo

In disciplines where formal logic and serial thinking are not predominant such as art and design the thinking tends to be visual and lateral.^[34] Traditionally most academics are very strong verbally and have been trained to present their findings verbally. Previously access to empirical observations that had been recorded were not openly available, unlike the written findings of researchers which had long shelf lives in libraries and on digital repositories accessible through the internet.

³² University of Lincoln Rethinking Photography. Available from: <http://www.rethinkingphotography.com> Accessed 04/05/2015.

³³ Schaaf, M. Michael Schaaf Photography. Available from: <http://mics-foto.de> Accessed 27 May 2016.

³⁴ Gray, C. and Malins, J. (2004) Visualizing Research. A Guide to the Research Process in Art and Design. Ashgate Publishing Limited.

Youtube ^[35] and Vimeo ^[36] are changing this norm ^[37] allowing anyone with access to an internet connection to publish and upload digital media content. The advantage is that it allows visual information to be disseminated globally and instantaneously. The disadvantages to this is that previously available video footage can be removed without warning, especially if made public without consent from the author or copyright holder and secondly it can also disseminate misleading information to a wide audience very quickly. Like all reference material the authenticity must be verified, and traceable to the origin and shown to come from a reputable source. Photographic initiations such as the Getty Institute have a highly insightful selection of video demonstrations of printing processes such as the Woodburytype. Please note that the Woodburytype demonstrations appear to be demonstrations designed to show the theory behind the method and do demonstrate the process with the traditional printing plates and presses. While not a traditional source of reference material, it allows anyone with access to a camera and the internet to post their findings and observations online to a global audience.

2.4.26 On-line forums and digital communities

Engagement and dissemination of information through digital and social media is actively encouraged by UWE, Bristol. It is also a practice undertaken by other academics in the field where information can be exchanged and debated. One online personal blog and forum that was found to be of great use within the research was that of Dr. Michael Pritchard, director of the Royal Photographic Society.^[38]

2.5 Empirical Investigation

Empirical investigations under controlled conditions were designed to examine the relationships between specific elements of the existing models and the new polychromatic print model. The purpose of these investigations was to isolate the variables and constraints and through detailed observation record their effect on the models as a whole and in detail. The benefits of empirical investigation is that it allows the identification of the key variables and factors that cause the observed results and that replication of the testing process can verify the results as it takes place under closed control of variables. Through the manipulation, inclusion, and exclusion of the identified key variables a working process model can then be generated. Empirical investigation is vital to this research as it allows for the discovery of new variables

³⁵ Google YouTube. Available from: <https://www.youtube.com>

³⁶ Vimeo Vimeo. Available from: <https://vimeo.com> Accessed 27 May 2016.

³⁷ Basil, M. (2011) Use of photography and video in observational research. *Qualitative Market Research; an International Journal*. 14 (3), pp.246-257.

³⁸ <http://britishphotohistory.ning.com/profile/MichaelPritchard> (Accessed 21/08/2016)

and their relationships between each other enabling a desired printed outcome to be reproduced consistently.

2.5.1 Empirical observation and measurement.

Initial empirical investigation relies on detailed observation of changes that occur following the introduction or removal of variable controls. The observations are used to identify the causes and effects of the independent and dependent variables. Through the manipulation of these variables I can control specific visual qualities within the final printed outcomes. Empirical testing in this research is considered to be an appropriate method as the actual act of printing is very similar to the testing procedures themselves. The printing process typically occurs in a convenient location where there is a closed control of variables. The timeframe for the actual 'doing' of the empirical tests of a relatively short duration and is expected to be repeatable and precise. Unlike other disciplines that may use an empirical investigative approach, empirical testing in printing is generally not conducted in an artificial setting. The only disadvantage that I encountered through empirical investigation is that the printing process relies on a human facilitator and human observer. In this research I was the facilitator and end observer. Whilst I remained objective throughout the study, ultimately the final printing process is designed for the creation of subjective prints. In which case personal preference is introduced and this is an uncontrollable and unavoidable variable.

2.5.2 Identification of known key variables and controls through literature

Through literature review previous knowledge generated in other studies was gained. This identified empirical investigations that need to be recreated, tested and either verified or refuted. This enabled a working understanding of both the historical printing method, and contemporary approaches to this specialism in the field. The procedures were observed and critically reflected upon. The tests were conducted in controlled conditions to ensure consistency in the results and minimise uncontrolled variables.

2.5.3 Identification of new key variables and controls through testing methods

The goal of the testing methods employed within this research is to have rigour, coherence and consistency to a professional standard. Their aim was to produce data that is valid using methods that are reliable and that conformed with ethical standards.

2.5.4 International Standards and test prints

Testing methods were conducted as closely as possible to the methods recommended within the British Standards Institute (BSI), the International Standards Organisation (ISO) and the American Society for Testing and Materials (ATSM). These institutions are used to produce repeatable coherent testing to a professional standard. Manufacturers today adhere to some system that allows for accurate repeatability in manufacturing procedure and supply chain management. Test methods either follow or are based on the procedures recommended by these institutions. Testing methods were generated through the knowledge gained from BSI and ISO in the creation of repeatable tests. The tests were flexible enough to producing data results that could be recorded and verified quantitatively with minimal variation and high degrees of tolerances while being used for a subjective outcome. The results from the testing was used as a benchmark starting point so that Action research methods (Chapters 4 and 6) could then be implemented.

2.5.5 Measuring Devices

Spectrophotometer and densitometers were available and their usage explored. These measurement tools are designed for standardised testing procedures on flat prints. It was not possible to guarantee accurate readings on the devices when measuring prints with a high topographical surface. In these instances observational viewing occurred following recommendations from BSI and ISO procedures.

2.6 Ethics

There were no ethical issues or grey area considerations within this study. Testing procedures where possible followed the guidance set out by standardisation organisations to ensure consistency. No human subjects or participants were used or required.

2.7 Multiple methods and triangulation approaches

Both historical, and contemporary literature surveys highlighted developmental and educational gaps which led to having to gain historical knowledge through empirical research. This was reinforced through empirical observation for the processes that I realistically did not have the time available to get to a high level of proficiency of execution. A triangulation approach was taken where theoretical understanding from different viewpoints was integrated with empirical testing. ^[39] This approach

39 GRAY, C. and MALINS, J., 2004. Visualizing Research. A Guide to the Research Process in Art and Design. Ashgate Publishing Limited.

allows for mutual checks against what was being said and providing me with the most comprehensive coverage of the claims and observations under investigation.

2.7.1 Empirical development and testing

Accumulating new data through the systematic design of tests was considered the most appropriate method given the time available to do the research project and the research that preceded it. Systematic design is a design process methodology best described by J. Christopher Jones ^[40] where his model states that systematic design can be broken down into three key components - analysis, synthesis, and evaluation. It was regarded the most appropriate empirical method for collecting the type of data necessary for addressing the issues, problems and questions that underpin the research. Using this model I have been able to generate several tests allowing for quantitative description, statistical analyses, and numerical generation of data to be recorded enabling the calibration and refinement of tooling processes and image resolution and output. This allows repeatability in the actual printing processes ^[41]. Building on the empirical investigation leads directly into action research.

2.7.2 Action Research

Action research is best suited for hands on small scale research projects (McNiff and Whitehead 2006, ^[42] Reason and Bradbury 2006, ^[43] Somekh 2006;^[44] Koshy 2010) ^[45]. Generally it is used as a method to improve a particular method, process, or practice that may arise as a routine part of activity in the real world. The goal of action research is to enable the practitioner to bring about an improvement in their own practice (Birley and Moreland, 1998). When problems within a model are identified, variables in the process can be changed providing information in a feedback loop. This method allows for the fine-tuning of a process through multiple iterations and tests. Variables can be adjusted in each iteration through a cyclical process of Plan, Act, Observe, Reflect. Each iteration generates the possibilities of change which can either be implemented or fed back into the feedback loop.

40 CROSS, N., ed, 23/11/1984. *Developments in Design Methodology*. 1 edn. Wiley.

41 LAWLER, B.P., 2006. *The Official Adobe Print Publishing Guide*. 2 edn. USA: Adobe Press.

42 McNIFF and WHITEHEAD 2006, *Doing Action Research in Education*, SAGE Publications.

43 REASON and BRADBURY 2006, *Handbook of Action Research*. 2edn. SAGE Publications

44 SOMEKH 2006;

45 KOSHY, V, 2010. *Action Research for Improving Educational Practice*, 2 edn. SAGE Publications.

2.8 Qualitative and Quantitative

The aim of qualitative research is to transform information from observation into written words or imagery and not into numbers. (Denscombe, 2010) ^[46]

The aim of quantitative research is to measure phenomena so that they can be recorded and reported as numbers that can then be analysed.(Denscombe, 2010) ^[47]

2.9 In summary

The methodological approach of this research is theoretical and empirical. Theoretical elements are addressed in Chapter 3 and Chapter 5. The empirical investigation is qualitative and quantitative and these aspects are presented in Chapter 4 and Chapter 6. Critical reflection occurs in Chapter 7 where strengths and areas of potential further development will be discussed in conjunction with the shortcomings and problems that were encountered.

⁴⁶ DENSCOMBE, M. (2010) The Good Research Guide: For Small-Scale Social Research Projects. 4th ed. UK: Open University Press.

⁴⁷ DENSCOMBE, M. (2010) The Good Research Guide: For Small-Scale Social Research Projects. 4th ed. UK: Open University Press.

3 Historical Developments

Synopsis: This chapter discusses the development and importance of the Woodburytype printing process within the context of this research. Developments within photographic and photo-mechanical processes will be introduced. When these processes are viewed in a chronological order the influences that lead to the invention of the Woodburytype process become apparent.

“The most beautiful photographic reproduction process ever invented” ^[1]

J.S. MERTLE

3.1 Literature review specific to this chapter

3.1.1 Photographic history

There has been much written about photographic history in great detail. A standard history can be found in the “Encyclopedia of Nineteenth-Century Photography” (Hannavy, 2008)^[2] and the “Encyclopedia of Twentieth-Century Photography” (Warren, 2005).^[3] This chapter is not going to recreate this history again, but comment on history related specifically to printing and the printing of images. What this brief historical study is doing is to highlight some of the important discoveries that acted as stepping stones to further the development of the photomechanically printed image. Within the literature reviewed there have been several key texts that concisely cover a general history of photographic practices, in particular ‘History of photography’ (Eder, 1932)^[4] (Translated by Epstein, 1978)^[5], ‘Keepers of Light’ (Crawford 1979)^[6], ‘Encyclopaedia

¹ Mertle, J.S. (1957) The Woodburytype. The most beautiful photographic reproduction process ever invented. Image.the Journal of Photography and Motion Pictures of the George Eastman House. 53 (September), pp.165-170.

² Hannavy, J., ed. (2008) Encyclopedia of Nineteenth-Century Photography. 1st ed. USA: Routledge.

³ Warren, L., ed. (2005) Encyclopedia of Twentieth-Century Photography (Volume 1-3). 1st ed. USA: Routledge.

⁴ Eder, J.M. (1932) Geschichte Der Photographie. 4th ed. Germany:

⁵ Eder, J.M. (1978) History of Photography. 4rd ed. USA: Dover. Translated by Epstein, Edward.

⁶ Crawford, W. (1979) The Keepers of Light. A History & Working Guide to Early Photographic Processes. 1st ed. New York: Morgan & Morgan Ltd.

of Nineteenth-Century Photography, Volumes 1-2' (Hannavy 2008)^[7], 'Encyclopaedia of Twentieth-Century Photography, Volumes 1-3' (Warren 2005)^[8].

3.1.2 Photomechanical print history

Photography itself is not a printing process, it is the creation an image through a chemical reaction caused by light. Many of the continuous-tone printing processes, such as photogravure, collotype, and Woodburytype were photo-mechanical in nature and as such relied on elements of photography to manufacture the printing plates from which image reproductions could be generated through a mechanical means. The Woodburytype process is of interest in this study as it is truly continuous-tone. Prints produced by this process contain no cell structure or reticulation. The figure below presents a microscope image capture from three of the main methods of continuous tone photomechanical printing.

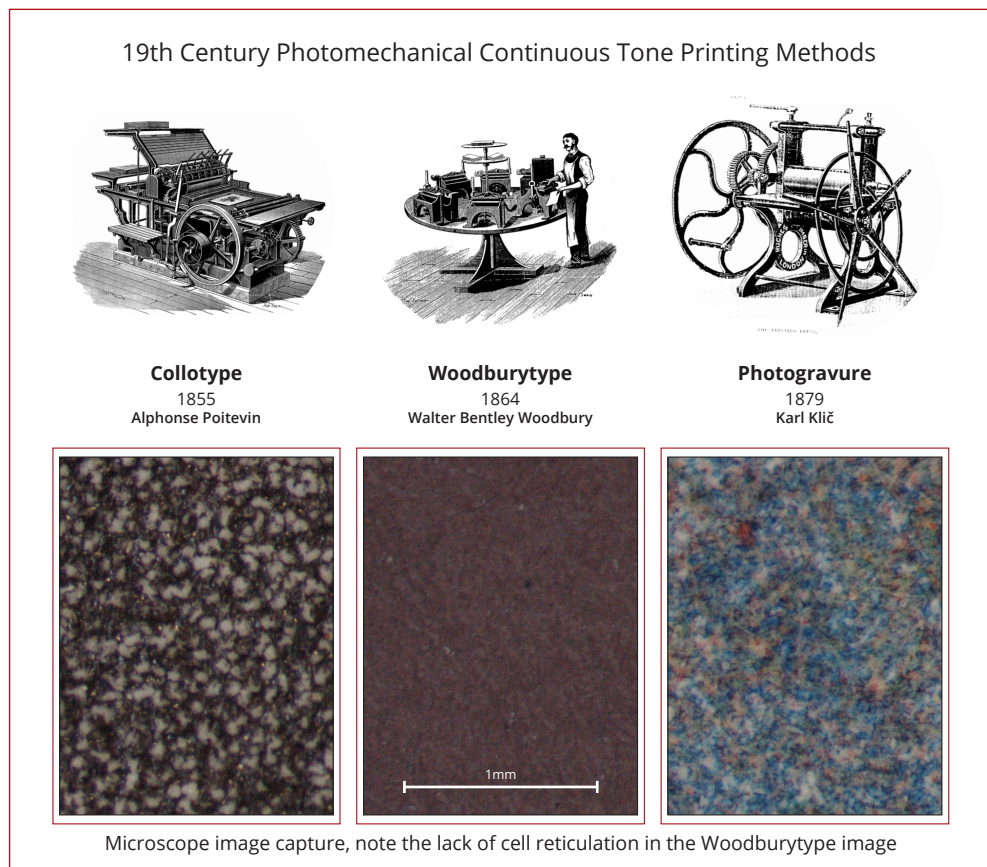

Figure 3.1 19th century photomechanical continuous tone printing methods. Illustrations published in the Engineer 1888

⁷ Hannavy, J., ed. (2008) Encyclopedia of Nineteenth-Century Photography. 1st ed. USA: Routledge.

⁸ Warren, L., ed. (2005) Encyclopedia of Twentieth-Century Photography (Volume 1-3). 1st ed. USA: Routledge.

The key text that clearly defines all aspects of photomechanical printing is the 'Encyclopedia of Printing, Photographic, and Photomechanical Processes' (Nadeau 1990)^[9]. The research by Nadeau has spanned over 30 years and has been referenced in hundreds of publications with particular interest in the permanent and archival, non-silver processes and colloid processes (Lawlor)^[10].

3.1.3 Identifying prints and colour

Specific descriptors are used throughout this doctoral research with reference to prints and printing. This study recommends that for a concise background into the nature of prints that the following texts are reviewed, *Stochastic Screening* (Tritton, 1996)^[11], *Digital Print Portfolio* (Lowe, 1997)^[12], *Digital Color Imaging Handbook* (Sharma 2003)^[13], *How to Identify Prints* (Gascoigne 2004)^[14], *Mastering Digital Printing* (Johnson, 2005)^[15], *The Printed Picture* (Benson 2008)^[16], *Characterization and Identification of Printed Objects* (Fernandez 2008)^[17], *Modern Digital Halftoning* (Lau & Ace 2008)^[18], *Fundamentals of Digital Imaging* (Trussell & Vrhel, 2008)^[19], *The Semantics of Colour – A Historical Approach* (Biggam, 2012)^[20]. While these publications describe many of the physical qualities of prints they are all produced with half-tone reproductions, all with the exception of Lowe's *Digital Print Portfolio* where a physical example of each process is presented. Later in Chapter 6 I will present microscope captures of my own duotone and trichromatic prints alongside microscope captures of other processes to allow for a visual comparison between processes.

-
- 9 Nadeau, L. Encyclopedia of Printing, Photographic, and Photomechanical Processes: A Comprehensive Reference to Reproduction Technologies, Containing Invaluable Information on Over 1500 Processes online. Fredericton, N.B., Canada : L. Nadeau, c1989-c1990.
- 10 Lawlor, M.C. (2016) About Luis Nadeau. Available from: http://www.photoconservation.com/index.php?option=com_content&view=article&id=46&Itemid=55 Accessed 03/07/2016.
- 11 Tritton, K. (1996) Stochastic Screening. Surrey, UK: PIRA International.
- 12 Lowe, A. (1997) Digital Prints
Conceived and Edited by Adam Lowe 50 pages Edition of 50 box sets plus 500 hardback books. At: London: Permaprint London
- 13 Sharma, G., ed. (2003) Digital Color Imaging Handbook. USA: CRC Press.
- 14 Gascoigne, B. (2004) How to Identify Prints. A Complete Guide to Manual and Mechanical Processes from Woodcut to Inkjet. 2nd ed. London: Thames & Hudson.
- 15 Johnson, H. (2005) Mastering Digital Print. 2nd ed. USA: Thomson Course Technology PTR.
- 16 Benson, R.V. The Printed Picture online. New York : Museum of Modern Art : c2008.
- 17 Fernandes, L.J.O. (2008) Characterization and Identification of Printed Objects. Universidade de Nova de Lisboa. https://run.unl.pt/bitstream/10362/1763/1/Fernandes_2008.pdf.
- 18 Lau, D.L. and Ace, G. (2008) Modern Digital Halftoning. 2nd ed. CRC Press, Taylor & Francis Group.
- 19 Trussell, H.J. and Vrhel, M.J. (2008) Fundamentals of Digital Imaging. 1st ed. USA: Cambridge.
- 20 Biggam, C.P. (2012) The Semantics of Colour. A Historical Approach. 1st ed. USA: Cambridge University Press.

3.1.4 Gelatine processes, Carbon Transfer and the Woodburytype printing process

There are four key contemporary texts specific to the Woodburytype process, *The History of the Woodburytype* (Oliver 2007) ^[21], *Walter Woodbury a Victorian Study* (RPS, 2008) ^[22], *Woodburytype* (Stulik & Kaplan, 2013) ^[23], *Carbon* (Stulik & Kaplan, 2013) ^[24]. These texts provide a streamlined overview with a social commentary into the development of the Woodburytype. Atkinson's thesis (2005)^[25] begins to touch on creating a working model so that the process can be re-appraised and developed, however due to technical limitations he states that he was unable to make the metal printing plates. *Light Sensitive Systems* (Kosar, 1965) ^[26] provides a very detailed insight into the chemistry of colloid printing and photographic processes.

3.2 Historical Timeline of key photographic events leading to the Woodburytype

This section will now give a brief overview of the photographic and photomechanical processes important to this research. In order to describe the Woodburytype process it is important first to address the preceding events in photography and printing that have transferable steps within their processes, that would have helped develop the knowledge needed to create the Woodburytype process. While the developments may not have been a direct precursors to Woodbury's process they would have been incremental starting points that when combined would result in a complete working photomechanical process. It is clear that there is a very strong connection between the various methods and the final Woodburytype process enabling it to become a process of printed perfection.

1727 Silver compounds are light sensitive, Johann Heinrich Schulze

The beginnings of the chemistry that were instrumental to photography began in the early 18th century in 1727 when Johann Heinrich Schulze began experimenting with jars of silver compounds and paper stencil masks. When placed against the jar and exposed to a light source the salts would darken. Where the salts were masked in the jar, they would remain a lighter colour, that is, until they too were exposed to light and then they would also darken in colour, while this is instrumental to the photographic

21 Barret, O. (2007) *A History of the Woodburytype*. 1st ed. Nevada City, California: Carl Mautz publishing.

22 The Royal Photographic Society, Victorian Chapter (2008) *Walter Woodbury. A Victorian Study*. 1st ed. Melbourne, Australia: RPS Victorian Chapter.

23 Stulik, D.C. and Kaplan, A. (2013) *The Woodburytype*. 1st ed. United States: J. Paul Getty Trust.

24 Stulik, D.C. and Kaplan, A. (2013) *Carbon*. 1st ed. United States: J. Paul Getty Trust.

25 Atkinson, A. (2005) *The Creation of Digital Photographic Fine Art Print through the Woodburytype Model*. University of the West of England.

26 Kosar, J. (1965) *Light-Sensitive Systems: Chemistry and Application of Nonsilver Halide Photographic Processes*. New York: John Wiley & Sons.

process, (Newhall, 1964) ^[27] (Eder, 1978) ^[28] the use of silver salts for photography didn't occur until almost a century later through the experiments of Herschel, Fox Talbot and Niépce. (Frizot, 1998) ^[29]

1802 Images with light on paper, Thomas Wedgewood

Wedgewood (the son of the famous British potter) was familiar with the use of the camera obscura as it was used in the pottery industry to aid in the decoration of ceramic plates. Wedgewood experimented with Schultze's discovery of light sensitive silver nitrate salts by using them to sensitise paper and leather. He placed flat objects and painted transparencies onto the sensitised paper and exposed it to daylight. Wedgewood was unsuccessful in making the image permanent, and when the exposures were viewed in daylight the image continued to expose and burnt out. The result was that the only way Wedgewood could view his images was very carefully by candlelight.

c.1826-c.1829 Heliography – early photography, Nicéphore Niépce

Nicéphore Niépce was an avid inventor. He was working on methods to improve the lithographic process when he started to experiment with photosensitive materials and the camera obscura. Niépce originally intended to copy artwork and drawings by using silver chloride which was more photosensitive than the silver nitrate that Wedgewood used. The initial work by Niépce describes that a negative image was generated from the exposure. Had Niépce been able to get a double exposure he would have been able to reverse this to create a positive image. Unfortunately he was unable to do so and decided to explore alternative chemistry that would produce a positive image. Niépce found that by using a photosensitive asphalt called Bitumen of Judea he could create insoluble areas that were exposed to the light. The unexposed areas remained soluble and could be washed away with oil of lavender. Niépce's first attempts at using this new process focused on recreating the black and white areas generated by metal printing plates. He did this by sensitising the plates with the bitumen and exposing them. When washed with the lavender oil the plates could then be treated with acid to bite into the bare unexposed areas of metal. Having seen that this was somewhat successful Niépce decided to put smaller exposed plates into camera obscura to see if he could capture images from nature onto the plates. He was successful in permanently fixing a positive image onto the plate. This is the first successful example of a photographic process. (Newhall, 1964) ^[30]

²⁷ Newhall, B. (1964) The history of photography.

²⁸ Eder, J.M. (1978) History of Photography. 4th ed. USA: Dover. pp73

²⁹ Frizot, M. (1998) The new history of photography. pp19

³⁰ Newhall, B. (1964) The History of Photography. 1st ed. New York: The Museum of Modern Art, New York.

1839 Photosensitivity of Sodium Bi-Chromate of potassium, Mungo Ponton

Ponton discovered that potassium dichromate renders colloids photosensitive. (Kosar, 1965), ^[31] and as it is considerably cheaper than nitrate of silver (Ponton, 1839) ^[32] eventually superseded it in gelatine based processes.

c.1833-9 William Henry Fox Talbot invents Calotype (See 1841 Calotype)

Fox Talbot invents the Calotype but does not declare it until 1841 for fear that Daguerre will get primacy of chemically fixing an image to a photosensitive substrate.

1838 Galvanoplastie – Moritz Herman Von Jarobi

(Precursor to electrotyping, See **1840 Electrotyping**)

1839 Daguerreotype, Louis Daguerre

Initially Daguerre presented an image but with no technical details which were finally presented in August 1839. Daguerre was a talented painter who through expert use of the camera obscura painted opera and theatre backdrops including the 45.5' x 71.5' sets for the diorama theatre in France. His use of the camera obscura led him to experiment with creating images through photosensitive materials. In 1826 Daguerre sent a letter to Nicéphore Niépce (Heliography, c.1826-c.1829) stating that he was experimenting with images along the same vein as him. They eventually formed a formal partnership to last ten years in 1829. Niépce died in 1833 after only four years of the partnership. Daguerre continued working towards the goals that he and Niépce set out to achieve. He made modifications to Niépce's methodology and in 1837 he created what was to be named the Daguerreotype. In 1839 the process was demonstrated to the director of the Paris Observatory, Francois Arago. Daguerre then went on to lecture about his process to the Academy of Sciences in January of the same year. The technical details of his process were not made public until August 1839 where it was presented to the Academy of Sciences and the Academy of Fine Arts. The principle of bringing out an image after exposure still remains a key feature in the development of photography

Daguerre's process was extremely dangerous as it involves 'bringing out the image' by holding it over mercury vapour. The process is still considered hazardous and for this reason (Webb, Reed, 1999) ^[33] it was omitted from the book '*Spirits of Salts – a working guide to old photographic processes*'.

31 Kosar, J. (1965) Light-Sensitive Systems: Chemistry and Application of Nonsilver Halide Photographic Processes. .

32 Ponton, M. (1839) Notice of a cheap and simple method of preparing paper for photographic drawing, in which the use of any salt of silver is dispensed with. The Edinburgh New Philosophical Journal. (July),

33 Webb, R. and Reed, M. (1999) Spirit of Salts. A Working Guide to Old Photographic Processes. London: Argentum, Aurum Press.

1840 Electrotyping, Robert Murray

Murray presents to the Royal Institute on electrotyping printing plates.

Electrotyping or electroforming is a process in which the metal is deposited through the process of electrolysis (using a direct current (DC) to cause a chemical reaction). An example of one method is to add a metal salt such as copper sulphate (CuSO_4) to water and an electric current is passed through it. The electrical current causes the copper particles (Cu) and the sulphate particles (SO_4) to separate into what are called ions. The copper ions are positively charged and the sulphate ions are negatively charged. The electric current causes the copper ions to travel towards a positively charged cathode where the metal is deposited and the sulphate ions to travel towards a negatively charged anode that is dissolved (replacing the loss of the copper being removed from the solution due to the metallic deposition). (Curtis, 2004)^[34]

1841 Calotype (later called Talbot type) announced – Fox Talbot

Daguerre announced his Daguerreotype process in 1839 claiming to be the first to have solved the problem of fixing photographic images to a sensitised substrate. News of this reached William Henry Fox Talbot who had also been working towards a solution. Talbot was extremely knowledgeable with chemistry and assumed that Daguerre's process was similar to his own mainly due to the fact that details of Daguerre's process had not been made public at this stage. Talbot's contention was that he had solved the problem in 1833-34, six years before Daguerre, but he withheld announcing it as he wanted to develop it further. In a panic Talbot sent images that he had generated through his process to the Royal Society with an accompanying paper to gain primacy, he also supplied descriptions of the images and the technical details of his process. Talbot was visiting Herschel, his friend and inventor of the cyanotype. Herschel demonstrated to him a method of fixing his image using Sodium thiosulfate, known in photographic terminology as "hypo". Talbot incorporated this method into his own practice without any objection from Herschel who had taken legal action against infringements on his work in the past. The prints that Talbot had presented to the society were reversed, but he solved this problem by re-coping the image. Herschel described Talbot's new technique as being a "negative-positive" one.

Talbot's process was suitable for mass duplication of an image as it was produced from a single negative, unlike Daguerreotypes which were unique. The image captured from the Daguerrotype required shorter exposure times and was much finer. Talbot reassessed his approach and changed his process so that similar to the Daguerrotype the image could be 'brought out' after exposure through chemical washes. This new process, initially called the calotype and later changed to the Talbotype, could now

34 CURTIS, L., 2004. Electroforming. 1 edn. London: A&C Black Publishers Ltd.

capture positive images with a short exposure time and mass produce them for publication on treated paper. (Newhall, 1964) ^[35] (Frizot, 1998) ^[36] .

1851-1855c Collodion Process, (Wet Plate) Fedrick Scot Archer

Archer described his process in “The Chemist”. It involves the pouring of a collodion and Potassium iodide solution onto a glass plate, then before the ether within the collodion solution evaporates it is sensitised in a bath of silver nitrate. While the plate is still wet it is placed into a camera and exposed and processed immediately before it dries, hence the name Wet Plate Collodion Process. Once dried the glass plate is varnished to seal the image and protect it. From this glass negative contact prints can then be made using sensitised printing out papers such as those used for albumen paper process (Louis Désiré Blanquart Evrard late 1840s / May 27th 1850). Archer also described a variation of his process where the glass collodion negative is placed onto a dark background. The exposed and fixed negative image on the glass appears lighter and when placed onto a dark background it gives the appearance of a positive image. This variant was known as Ambrotype. (Coe & Haworth-Booth, 1983) ^[37]

1852 Photoglyptic engraving, Fox Talbot

Talbot, while experimenting with Ponton’s 1839 discovery, noted that bi-chromate of potash when mixed with organic substances such as gum or gelatine would cause them too to take on the light sensitive properties and become soluble / insoluble depending on their exposure to light. Fox’s photoglyptic engraving was an early attempt in photomechanical printing by attempting to create intaglio plates by etching images from Talbottypes (Crookes, 1858). ^[38]

1852 Nature Printing, Alois Auer

This is a method of printing that was first patented in 1852 by Alois Auer of Austria. The method involved placing organic objects of fine surface relief such as leaves, twigs, feathers or man made textiles such as lace between two metal plates of different hardness. The sheet of soft metal (traditionally lead) is placed on top of the sheet hard metal; originally copper, it was later replaced by sheet steel. The object that is to be printed is sandwiched between the two metal plates and rolled through a press consisting of two rollers screwed closely together. The pressure exerted upon the two plates forces the soft metal plate to take an impression of the organic matter beneath. The result is an intaglio printing plate being formed from the sheet of soft metal. The

³⁵ Newhall, B. (1964) *The History of Photography*. 1st ed. New York: The Museum of Modern Art, New York.

³⁶ Frizot, M. (1998) *The New History of Photography*. 1 (English) ed. Koln: Konemann.

³⁷ Coe, B. and Haworth-Booth, M. (1983) *A Guide to Early Photographic Processes*. 1st ed. England: The Victoria and Albert Museum in Association with Hurtwood Press.

³⁸ Crookes, W. (1858) Mr. Fox Talbot’s New Discovery: Photoglyptic Engraving. *Photographic News*. 1. No3 (24 September), pp.25-26.

intaglio plate can then be electrotyped with copper and printed from. The resulting print contains subtle tonal gradations and photorealistic details often not achievable by the photomechanical printing methods available at that time. (Hume, 2011) ^[39].

1855 Carbon process, Alphonse Poitevin

Poitevin continued exploring Ponton's and Fox Talbot's work with photosensitive gelatine focusing more on creating permanent photographic prints and photolithography. Poitevin was an engineer and chemist who set about to address the problem of repeatability within the daguerreotype process. In 1855 he patented the Carbon process. He realised that by adding powdered carbon to the bichromated gelatine sheets (tissues) and exposing them through a negative that a tonal image would remain within the insoluble areas of the gelatine. The soluble area could then be washed away to reveal the image. The first iteration of the Carbon process was only partly successful. While the principles within the methodology were theoretically sound, the printed results were not satisfactory enough to demonstrate halftones. In the second iteration of his process in 1860 Poitevin introduced a transfer method allowing the image to be transferred to gelatinised paper. The reason for the lack of halftones was observed by Abbé Laborde, in that the unexposed gelatine was behind the exposed gelatine and was thus unable to be washed away. Attempts to expose the gelatine from behind although correct in principle were unsuccessful as the paper interfered with the exposure and softened the details of the image. (King, 2003) ^[40], (Sullivan, 2007) ^[41], (Stulik & Kaplan, 2013) ^[42]

1858-1860c Autotypography, George Wallis

This printing method was developed between 1858 and 1860 by George Wallis, who after seeing examples of nature printing wanted to be able to reproduce drawings in a similar manner. In 1863 Wallis presented a paper describing his process titled "The new art of Autotypography" to the Royal Society of Arts. (Wallis, 1863) ^[43] The method consisted of drawing with or painting with a gelatine medium upon a sheet of gelatine. The gelatine would then be placed between a two sheets of metal. When dried the gelatine would be harder than the sheet of lead and an impression the artwork could be taken by rolling the metal plates through pressure rollers in the same manner in which a nature print is achieved (Anonymous, 1862). ^[44]

³⁹ Hume, N. (2011) The Nature Print and Photography in the 1850s. *History of Photography*. 35 (1), pp.44-58.

⁴⁰ King, S. (2003) *The Book of Carbon and Carbro*. Contemporary Procedures for Monochrome Pigment Printmaking. 1st ed. Greenville, South Carolina: Permanent Light Systems.

⁴¹ Sullivan, D. (2007) *The Bostick & Sullivan Book of Modern Carbon Printing*. 1st ed. Santa Fe, New Mexico: The Bostick & Sullivan Press.

⁴² Stulik, D. C. and Kaplan, A. (2013) *Carbon*. .

⁴³ Wallis, G. (1863) The New Art of Autotypography. *The Engineer*. (April 24), pp.229-230.

⁴⁴ Anonymous (1862) *The International Exhibition of 1862, The Illustrated Catalogue of the Industrial Department*. . 1 British Division 1 pp.86.

Wallis also noticed that because the gelatine is transparent a drawing could be placed beneath it and traced allowing for existing artwork to be traced. By building up height through brushing on washes of the gelatine this effect could then be reproduced in the print.

1860 Carbon transfer – Adolphe Fargier (1860 France) (Patented England 1861)

Fargier furthered the development of transferring carbon prints. Fargier poured the bichromated gelatine to make a tissue on top of a layer of collodion on a glass sheet. Once exposed the imaged was captured within the gelatine tissue. By developing the image under hot water the soluble unexposed gelatine melted away revealing the image still attached to the collodion layer. This could then be separated from the glass plate and transferred to a sheet of gelatinised paper. Once transferred it was treated with an ether wash which dissolved the collodion. This adaptaion of the process was technically very difficult to master but the image quality achieved in the print was to a very high standard (The Photographic Journal, 1867) ^[45] (Abney, 1896) ^[46] (Kosar) ^[47] .

1864 Carbon double tissue transfer (Swans Process), Joseph Swan

In 1864, Joseph Swan manufactured carbon tissue (sheets of prepared pigmented gelatine ready to be photosensitised) on a commercial scale. Once Poitevin's patent lapsed in 1858 he began to experiment with the Carbon process. After exposing the tissues under a negative and washing the print he would transfer the gelatine image to a temporary paper support. When dried the image would be in a reversed orientation. Swan coated the image with an adhesive rubber solution and then performed a second or double transfer of the image onto a final paper support. The image would now be in the correct orientation. Swan is considered to have perfected the Carbon process and often mistakenly credited as the original inventor. He patented his method in 1864. (The Photographic Journal, 1867) ^[48] (Abney, 1896) ^[49]

1864 Swans Double Transfer Carbon process patented

⁴⁵ Unknown (1867) Report of the commission of the French Photographic Society of awarding the Prize of 8000 francs founded by the Duc de Luynes for Printing Photographs in Ink. Photographic Journal. (July), pp.64-68-76.

⁴⁶ Abney, W.D.W. (1896) Affiliation of Photographic Societies. Six Lectures on "Photography with the Bichromate Salts" i) Scientific and Historil Preliminary. The Photographic Journal. May 29 (36), pp.254-259.

⁴⁷ Kosar, J. (1965) Light-Sensitive Systems: Chemistry and Application of Nonsilver Halide Photographic Processes. New York: John Wiley & Sons.

⁴⁸ Unknown (1867) Swan's Carbon Process. The Photographic Journal. 12 (July 16), pp.77.

⁴⁹ Abney, W.D.W. (1896) Affiliation of Photographic Societies. Six Lectures on "Photography with the Bichromate Salts" i) Scientific and Historil Preliminary. The Photographic Journal. May 29 (36), pp.254-259.

1864 September – Woodburytype – Walter Bentley Woodbury

Woodbury filed a patent application for his Photorelievo Process on 23rd September 1864 which was granted on March 1865. Woodbury developed a method of photomechanical printing that essentially created a printing plate by electrotyping a gelatine relief (an unpigmented carbon print). An ink made from warm gelatine and pigment was then poured into the electrotyped printing plate and placed against shellacked paper, while the gelatine was still warm and fluid, and mild pressure was applied to expel the surplus pigment. Once cooled the gelatine would solidify and the print could be removed from the printing plate. This method of printing was created independently from Swan's Photomezzotint process (1865). Woodbury later modified his process in which the printing plates could be obtained by impression under force or by casting. The impression method is a combination of carbon printing, autotyping and nature printing. A processed gelatine relief image is placed under a sheet of lead and a large amount of force is applied. The gelatine relief is impressed into the lead and can then be used as a printing plate with pigmented gelatine ink and shellacked paper. The casting method involves pouring molten sulphur onto the gelatine relief. When cooled the gelatine can be removed from the hardened sulphur. Cast or moulds can then be made from the sulphur impression. It was also possible to imprint the gelatine relief into soft plaster moulds. Over time the method of obtaining lead printing plates by force became the standardised method. (The Photographic Journal, 1865)^[50] (Simpson, 1865)^[51]

1865 Woodburytype presented**1865 Photomezzotint process (patented July), Joseph Swan**

Swan developed a method of photomechanically printing by electrotyping an unpigmented carbon print (Swan, 1865)^[52]. Created independently from Woodbury it became a subject of contention between the two.

1867 Woodbury filigraine, Walter Bentley Woodbury.

This is a process developed and patented by Walter B Woodbury in which a photographic gelatine relief made in the same manner as his photorelievo process is pressed against fibrous materials such as paper or card so that a photographic watermark is created. (British Patent 947 in 1867 with additional amendments and simplifications of the process described in patents No: 2171, 1870, No: 2912 In 1878 and No. 3760 in 1879.) It was suggested that it could be used to impress a likeness onto a

⁵⁰ Journal, P. (1865) New Method of Photo-relievo Printing. The Photographic Journal. (September 15), pp.150-153.

⁵¹ Simpson, W., G. (1864) A New System of Printing. Photographic News. (October 14),

⁵² Swan, J., Wilson. (1865, July 6) Improvements in the Production of Printing Surfaces by Photographic Agency, and in Obtaining Prints Therefrom. (British Patent 1791).

gentleman's calling card. (The Graphic, 1879)^[53]. It is unknown if this was ever used commercially or just for his own experimentation pre 1880s when it is believed to have been launched and was credited as a novelty. (Gill, 1970)^[54]

1868 Carbon transfer tri-colour, Louis Ducos Du Hauron

First Photographic printing process to use three-colour subtractive photography. Cyan, magenta and yellow separations were made from red, green and blue exposures and they were then manually registered on top of each other. (Newton, 1913)^[55]

1874 Photochromie / photochromy (Vidal Process), Léon Vidal

A combination process of lithograph and Woodburytype. This variation of combination printing was the closest that the Woodburytype got to colour printing commercially. Initially colours were printed with litho blocks in registration and then the final layer of black was printed on the reverse of the page as a Woodburytype print. (Vidal, 1891)^[56]

There were reports of true colour Woodburytypes being made but no evidence of prints exist, only an eyewitness account. One account reports that 2 to 3 colours were being printed as individual layers on a collodion support and when dried were manually lifted and registered. The prints were supposed to be of a high standard but without any prints to corroborate the eyewitness account it has to be taken at face value. Chromo-Woodbury (Blackburn Standard, 1890)^[57]

1879 Stannotype, Walter B Woodbury

This was Woodbury's final improvement on the Woodburytype before his death. The modification resulted in making printing plates without the need for the expensive and large hydraulic press. Initially the gelatine matrix was covered with gutta percha (a natural tree rubber) and a sheet of tin foil placed onto the surface and then electroformed. The electroform deposition was then removed and used as a printing plate. In later stages the electroforming stage was made obsolete and prints were lifted directly from the tinfoil surface. At this point in time the Woodburytype was slowly becoming obsolete itself and it had been superseded by collotype printing and the halftone screen processes.

⁵³ Anon. (1879) Scientific Notes. The Graphic. May 31 , 530.

⁵⁴ Gill, A.T. (1970) One hundred years ago. Photographic Journal. (August), pp.334-335.

⁵⁵ Newton, A.J. (1913) The Evolution of Photomechanical Illustration. The Photographic Journal. 53 (June), pp.206-212.

⁵⁶ Vidal, L. (1891) Photographic Methods of Obtaining Polychromatic Impressions. The Photographic Journal. 31 (May 22), pp.146-153.

⁵⁷ Anonymous. (1890) Photographs in Colour. The Blackburn Standard and Weekly Express. Saturday September 6, 3.

1900 Woodburytype Machine (patent), Paul Charles and Stephan Faujat

This British Patent 16803 shows 'plans' for a machine that supposedly could print a colour Woodburytype through automation. (Charles & Faujat, 1900)^[58] No prints exist from this machine, even though there are reports that they were beautiful. Again this is another account which has no evidence to back up the claims that colour Woodburytypes were obtainable.

1905 Ozobrome process, Thomas Manly

This was the earliest form of Carbro printing. Manly found that silver images could be used to make pigment images directly from bromide prints. The Ozobrome process made carbon prints without the photographic exposure by pressing a sheet of sensitized pigmented gelatine on bromide paper in firm contact with a silver image. The relief of the gelatine was in proportion to the amount of silver in the image (Kosar, 1965)^[59]. Ozobrome Process, Patent No: 148462 (June 16 1919) BJoP Nov 18 1921 P691 A method of turning a bromide print into an oil pigment as in the bromoil process. (Dictionary of Photography 1912)

1919 Carbro process, H.F. Farmer,

This was a combination of carbon and bromide processes (Kosar, 1965)^[60] as it does not rely on sunlight but a chemical reaction with a bromide print. (Willis, 1921)^[61] (King, 2003)^[62].

c.1920 Carbro tricolour replaces carbon tricolour.

A three-colour subtractive variation of the carbro process which became more popular than three-colour carbon due to the release of one-shot colour separation cameras but which produced smaller negatives. This was a disadvantage for tricolour carbon printing but not for carbro. (Nadeau, 1994)^[63].

⁵⁸ Charles, P. and Faujat, S. (1900) Machine for Production of Gelatine Pictures in Connection with Photography Anon.

⁵⁹ Kosar, J. (1965) Light-Sensitive Systems: Chemistry and Application of Nonsilver Halide Photographic Processes. .

⁶⁰ Kosar, J. (1965) Light-Sensitive Systems: Chemistry and Application of Nonsilver Halide Photographic Processes. .

⁶¹ Willis, A.G. (1921) The no light Carbo Process. British Journal of Photography. 68 (July 22nd), pp.434.

⁶² King, S. (2003) The Book of Carbon and Carbro. Contemporary Procedures for Monochrome Pigment Printmaking. 1st ed. Greenville, South Carolina: Permanent Light Systems.

⁶³ Nadeau, L. Encyclopedia of printing, photographic, and photomechanical processes: a comprehensive reference to reproduction technologies, containing invaluable information on over 1500 processes..

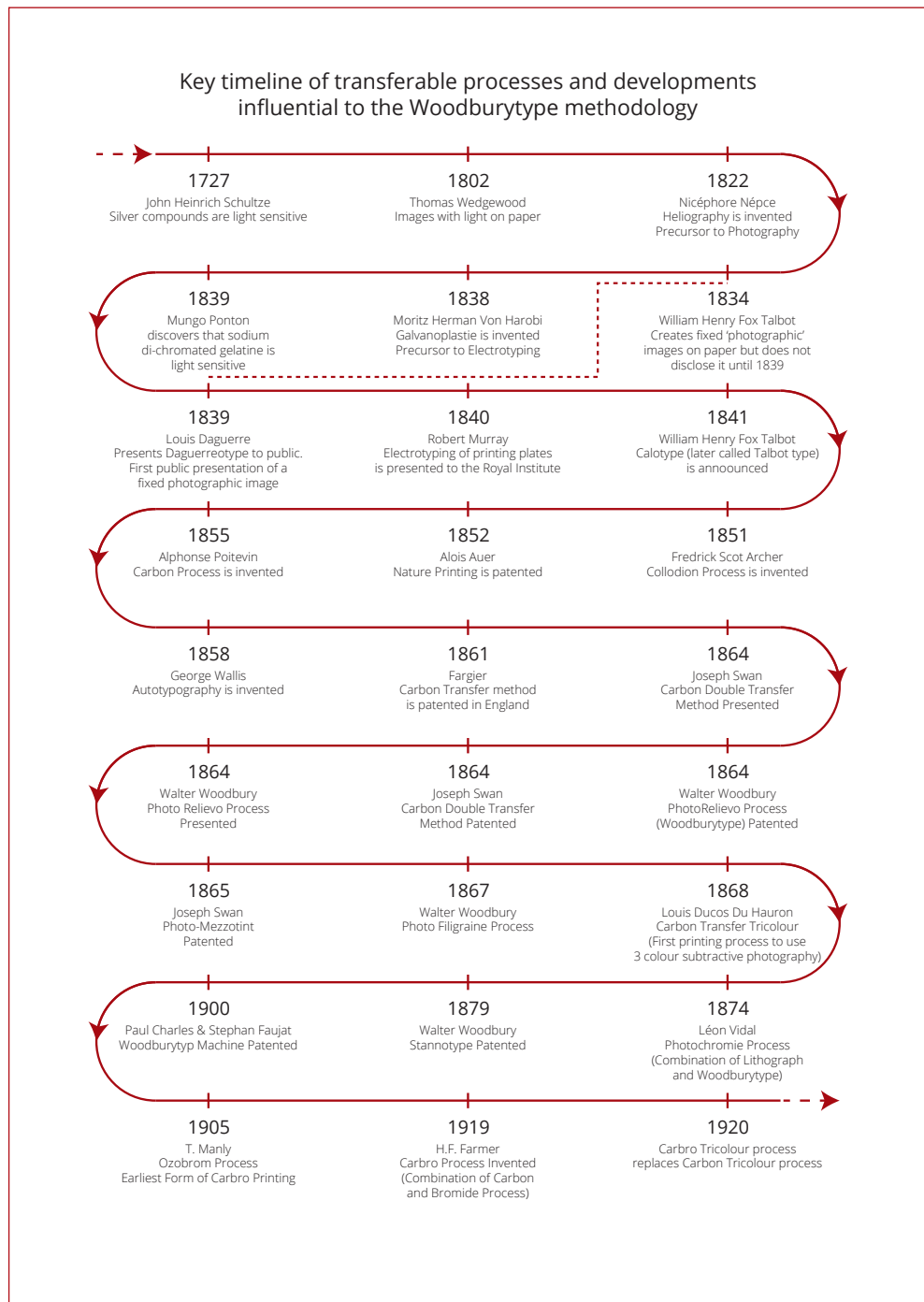

Figure 3.2 Key timeline of transferable processes and developments influential to the Woodburytype

3.3 Historical analysis of the Woodburytype

This historical analysis, reflects centrally around the Woodburytype process. While other near continuous tone photomechanical processes exist, such as the collotype and the photogravure process, emphasis within this research is being put on the Woodburytype. By analysing this historical process the research gathered from this doctoral study will be used to develop methods for the reproduction in continuous tone of digitally printed colour artworks and will be presented in Chapter 6. The Woodburytype is a true continuous tone (Gernsheim, 1987)^[64] photomechanical printing method. It was the only photomechanical printing method that could produce continuous tonal gradation (Cartier-Bresson 1998)^[65]. As seen in Figure 3.1 no reticulation exists within a Woodburytype print. Tones are generated through printing the image as a relief structure where the tonal range is adjusted by depositing thicker or thinner pigmented gelatine (Figure 1.7).

3.3.1 The Woodburytype and its context within this research

In the mid 19th century there was an imperative to find a printing method that could firstly, prevent a printed photographic image from fading, and secondly to be able to mass reproduce photographic images mechanically. The Woodburytype was one printing method developed to address this challenge put forward by the “*Institut de France*” and the “*Société Française de Photographie*” on permanency in photographic reproduction, (Fowler, R.J., 1867)^[66] The process earned its inventor a silver medal award (The Photographic Journal, 1867)^[67]. While examples of original 19thC Woodburytype show no signs of fading the opposite can be said of the Woodburytype process itself.

In the first description of the method contained in Woodbury’s initial patent (British Patent No 2338)^[68] the actual intent for the process and printing materials to be used are quite indecisive. The initial output for “photorelievo” printing was not as images on paper but portraits produced in ceramics and enamel.

Woodbury produced examples from this new process, but made them from gelatine and paper so that they could be shown to Mr G. Wharton Simpson, (Editor

⁶⁴ Gernsheim, H. and Gernsheim, A. (1987) *The History of Photography Volume II. the Rise of Photography 1850-1880. the Age of Collodion*. 3rd ed. London: Thames and Hudson.

⁶⁵ Frizot, M. (1998) *The New History of Photography*. 1 (English) ed. Koln: Konemann.

⁶⁶ Fowler, R.J. (24/05/1867) *The History of the Processes for the Production of Permanent Photographic Pictures in Printers’ Inks (Part 2)*. *British Journal of Photography*. XIV

⁶⁷ Anonymous (1867) *Permanent Printing*. *The Photographic Journal*. (Oct 15), pp.115.

⁶⁸ WOODBURY, W.B., 1864. *An Improved Method of Producing or Obtaining by the aid of Photography Surfaces in ‘Relievo’ and ‘Intaglio’ upon Aluminous, Vitreous, Metallic, or other suitable Materials*. 2338 edn. Britain:

of the *Photographic News*)^[69]. Little importance was placed on Woodbury's rough experiment and oddly he (Woodbury) did not see it as having a successful application. Simpson however saw the similarities of Woodbury's process and that of the then unannounced Photo-mezzotint process by Joseph Swan, from whom he had also been presented with prints a few months earlier (Simpson, 1865)^[70]. Unless Swan came forward, Simpson would have to publish Woodbury's process without acknowledging Swan (Swan, 1865)^[71]. Woodbury patented his variation first and later presented details of his process publically on 17 March 1865. (Woodbury, 1865)^[72].

This appears to be the starting point of the controversial historical dispute between Walter Woodbury and Joseph Swan both of whom developed two almost identical processes independently from the others knowledge (Simpson, 1864)^[73]. As both men admitted in their own patents that they did not fully invent the processes upon which their own methodologies were based, Woodbury offered half of his patent for his method of photorelievo printing as a sign of respect to Swan. Both men discussed going into partnership however it was never finalised and disagreements between the inventors escalated (Swan, 1865)^[74] (Woodbury, 1865)^[75] (Swan, 1865)^[76]. The relationship dissolved and a lengthy and costly legal battle ensued. Swan, despite having primacy of the processes walked away from the dispute and Woodbury eventually retained the patent rights.

On a side note, an obituary notice for Swan was found almost ten years after Woodbury's death where he was being credited as joint inventor of the Woodburytype (Wrexham Advertiser, 1894)^[77]

⁶⁹ Hannavy, J., ed. (2008) *Encyclopedia of Nineteenth-Century Photography*. 1st ed. USA: Routledge. Pp1086

⁷⁰ Simpson, W., G. (1864) A New System of Printing. *Photographic News*. (October 14),

⁷¹ Swan, J. (05/05/1865) Mr. Swan's Claim Versus Mr. Woodbury's. *British Journal of Photography*. XII

⁷² Woodbury, W.B. (17/03/1865) Woodbury's New Printing Process. *British Journal of Photography*. XII

⁷³ Simpson, W., G. (1864) A New System of Printing. *Photographic News*. (October 14),

⁷⁴ Swan, J. (05/05/1865) Mr. Swan's Claim Versus Mr. Woodbury's. *British Journal of Photography*. XII

⁷⁵ Woodbury, W.B. (12/05/1865) Mr. Swan's Claim Versus Mr. Woodbury's. *British Journal of Photography*. XII

⁷⁶ Woodbury, W.B. (12/05/1865) Mr. Swan's Claim Versus Mr. Woodbury's. *British Journal of Photography*. XII

⁷⁷ Unknown. (1894) Art and Science. *The Wrexham Advertiser*. Saturday 6 January, 7.

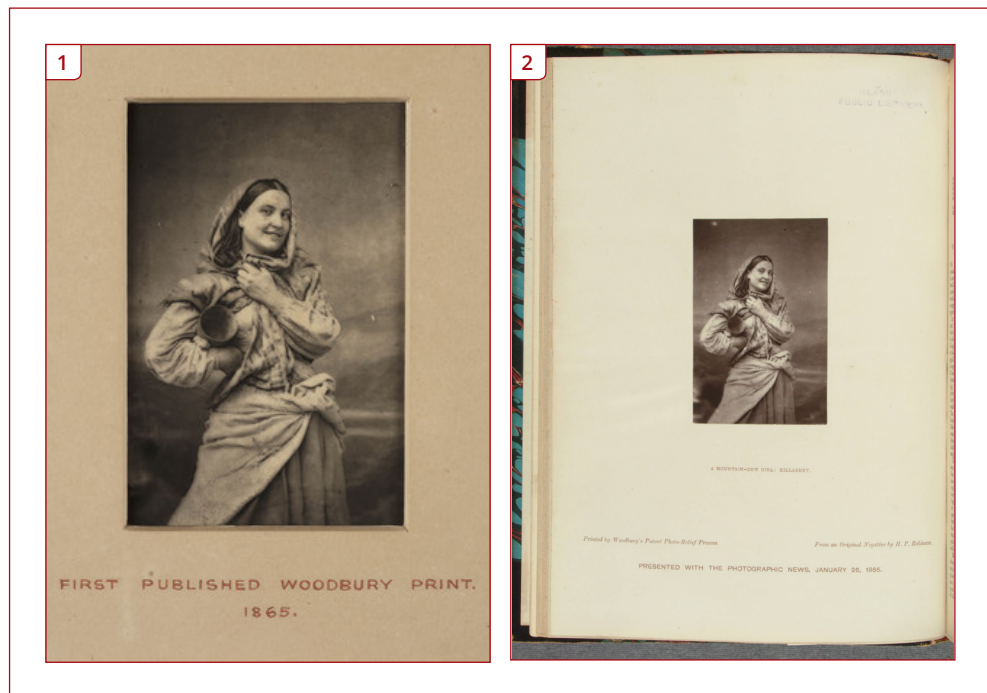

Figure 3.3 Mountain Dew Girl : Killarney, printed by Walter Woodbury. Negative by HP Robinson.

On January 26 1866 an edition of prints personally produced by Woodbury were included with the *Photographic News*. The print entitled “Mountain Dew Girl : Killarney” was from a negative by Henry Peach Robinson. It was the first publically presented Woodburytype print. ^[78]

MM Goupil et Cie (a large French photographic printing company) adapted Woodbury's process under licence (Sutton, 1870) ^[79] in 1865 in France where it was known as the photoglyptie (Dominique de Font-RéLaulx, 2008) ^[80] (*Amateur Photographer*, 1887) ^[81] . As the popularity of the process grew other regional variations of the name developed e.g. Woodburydruck / Woodburytypie in German (Nadeau, 1994) ^[82]

3.3.2 Development of the process

Woodbury left his engineering training in England and moved to Australia as a young

⁷⁸ Anonymous (1866) Our Presentation Print. - Woodbury's Process. *Photographic News*. X (January 26), pp.37-38.

⁷⁹ Sutton, T. (01/03/1870) A Week at the Woodbury - Printing Establishment of MM. Goupil at Ansières, near Paris. *The Photographic Art Journal*.

⁸⁰ Hannavy, J., ed. (2008) *Encyclopedia of Nineteenth-Century Photography*. 1st ed. USA: Routledge.

⁸¹ Unknown (03/06/1887) Fifty Years Development of the Graphic Arts. *Amateur Photographer*. V

⁸² Nadeau, L. *Encyclopedia of printing, photographic, and photomechanical processes: a comprehensive reference to reproduction technologies, containing invaluable information on over 1500 processes..*

man as part of the Gold Rush in 1852. He didn't find his fortune, and with the last of his money he bought a camera. In his youth he was a keen photographer. He did various labouring jobs and eventually worked with the Commissioners of Sewers and Water Supply for the City of Melbourne. Woodbury photographed the buildings during construction in his own time which got him noticed and began his reputation as an accomplished photographer.

Woodbury's proficiency in wet plate photography was evident when he set up Woodbury and Page, a successful photography studio with business partner James Page. He was a very well respected photographer working mostly in Australia and Java where he built a reputation photographing royalty and dignitaries of that area. (Royal Photographic Society, 2008) ^[83]. In the lead up to his return to England from Australia and Java in 1862 he made reference in his notes of acquiring copies of the photographic journals of the time as frequently as he could so that he could read as much as possible in order to keep up to date.

It is unknown if Woodbury adapted elements openly in regards to other printing processes but he would have been aware of new developments in the photographic sciences. This researcher believes that there are several discoveries that would have influenced the development of the Woodburytype photomechanical process within the time frame between 1822 and 1879. Early descriptions of the process make comparisons to components of other processes. For example it is mentioned that Fargiers carbon process was used to generate the gelatin relief needed to make the lead plates (The Photographic Journal, 1867) ^[84]

Woodbury's working knowledge of other printing and photographic techniques of the time will no doubt have played a part in the development of his own process both consciously and subconsciously, although never formally admitted by him. It is known that he was an avid reader of the photographic journals of that time and that he did run a successful commercial photographic business in Java where he was highly proficient in wet plate processes before his return to England.

83 The Royal Photographic Society, Victorian Chapter (2008) Walter Woodbury. A Victorian Study. 1st ed. Melbourne, Australia: RPS Victorian Chapter.

84 Unknown (1867) Report of the commission of the French Photographic Society of awarding the Prize of 8000 francs founded by the Duc de Luynes for Printing Photographs in Ink. Photographic Journal. (July), pp.64-68-76.

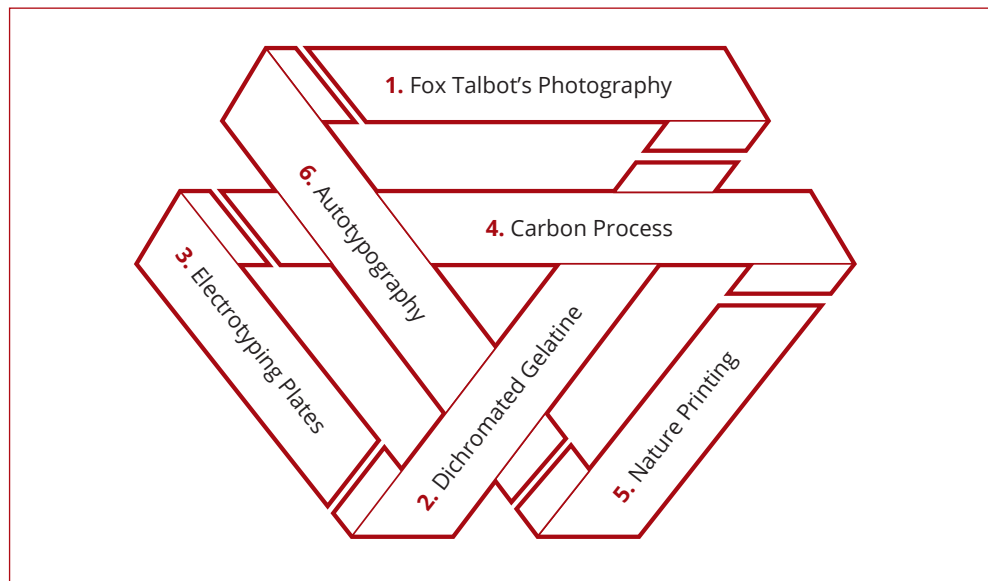

Figure 3.4: Methodologies transferable to the Woodburytype process

According to Nadeau (1994) – “This important process can probably be classified as the most photographic of the photomechanical processes.”^[85] The Woodburytype process is the only true continuous tone photomechanical print process ever invented and art historian J.S. Mertle (1957) states that it is “The most beautiful photographic reproduction process ever invented”^[86].

Within the historical documentation surrounding the Woodburytype there is an agreed and systematic approach to the process. The steps contained within this process are open to interpretation and as a result of this over time many iterations developed. One of the difficulties encountered by this research was finding a complete methodology looking at every specific detail of the process without generalising or assuming prior knowledge. Of the few modern studies on the Woodburytype available there appears to be one agreed methodology for the process. This agreed methodology is very streamlined in its description with the majority of the variations and nuances of each stage simplified, with the reason for this most likely to be that as the process is not readily available or practiced actual working accounts are scarce. The iterations also seem to vary depending on geographical location, and the scale of production.

⁸⁵ Nadeau, L. Encyclopedia of printing, photographic, and photomechanical processes: a comprehensive reference to reproduction technologies, containing invaluable information on over 1500 processes..

⁸⁶ Mertle, J. S. (1957) The Woodburytype. The most beautiful photographic reproduction process ever invented. Image, the Journal of Photography and Motion Pictures of the George Eastman House. 53(September), pp. 165-170.

As the process was developed before widespread use of photographic images, written descriptions were usually given in technical publications, with illustrations of the process being less often used than actual finished prints.

3.4 Simplified Woodburytype process – Key stages

One of the difficulties that this researcher has found in understanding the Woodburytype is that if you are initially unfamiliar with the process the illustrations like Figure 3.5 were used to explain it. It requires quite a bit of imagination on the part of the reader to visualise how the process works. These diagrams are difficult to understand particularly when explaining the process to someone with no prior knowledge.

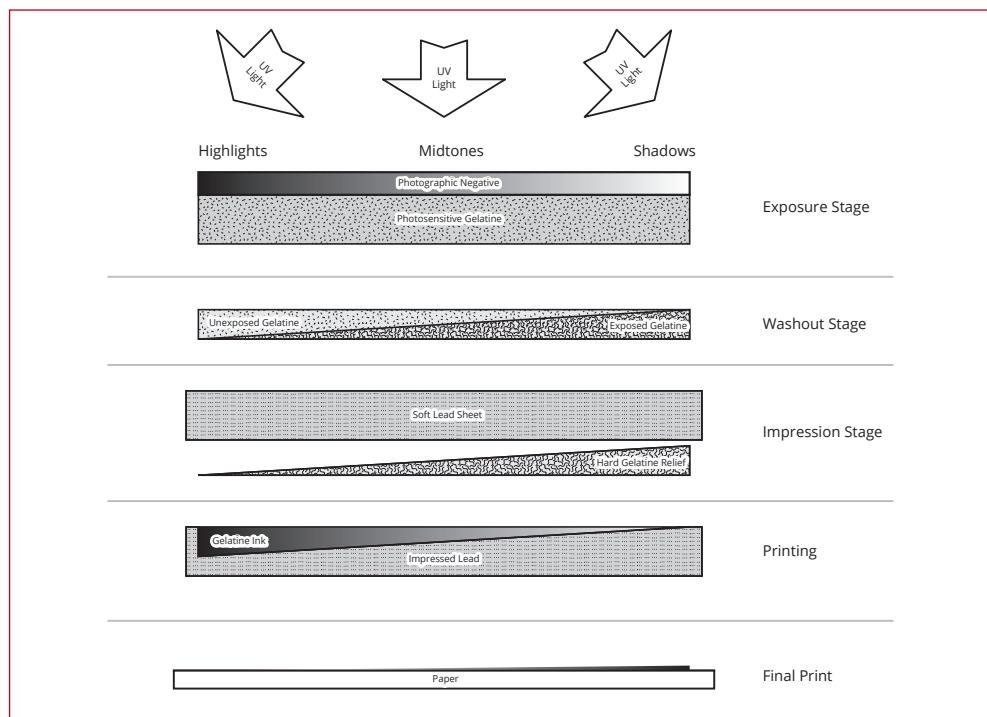

Figure 3.5 Simplified illustration highlighting the key stages of the Woodburytype process

3.5 The Woodburytype process – illustrations of key stages.

In an aim to increase clarity about the Woodburytype within this study a simplified 3D illustration of the keystages of the process has been produced. A full written description of the process combined with photographs taken during the empirical re-creation of the process will be presented In Chapter 4.

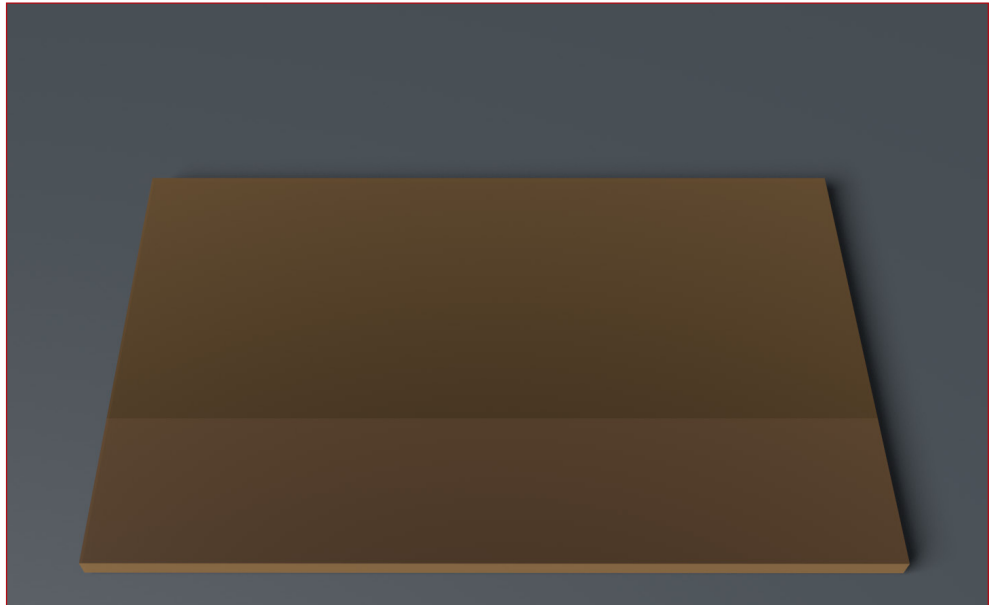

Figure 3.6 A thick sheet of gelatine tissue is cast and made photosensitive

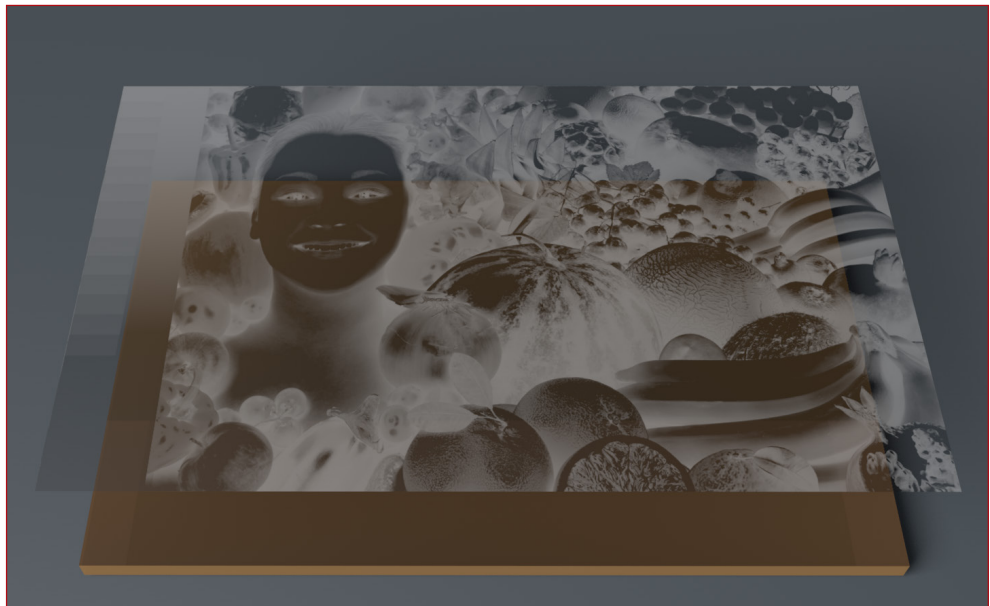

Figure 3.7 A photographic negative is placed onto the sensitised gelatine tissue

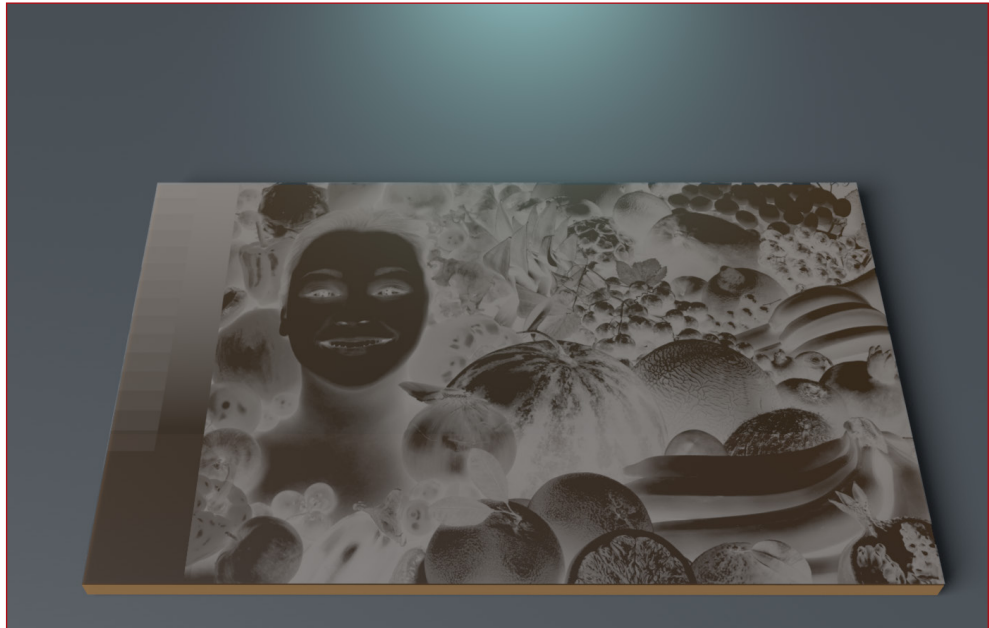

Figure 3.8 The photosensitive gelatine tissue is exposed through the negative

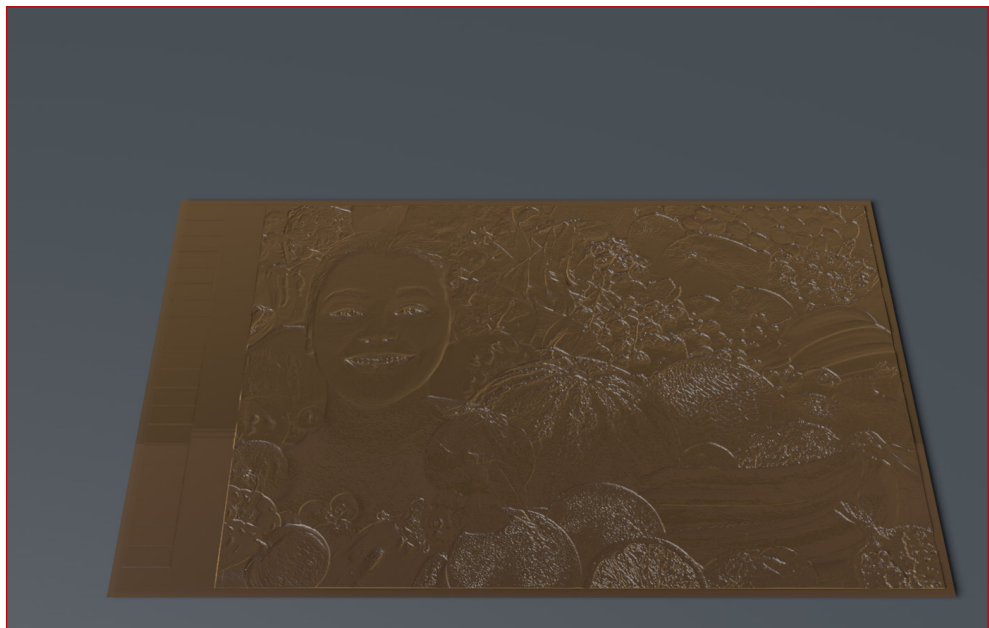

Figure 3.9 Once exposed the tissue is developed by washing away the unexposed areas to leave a relief



Figure 3.10 A billet of lead is pressed onto the dried gelatine tissue with a lot of even force.

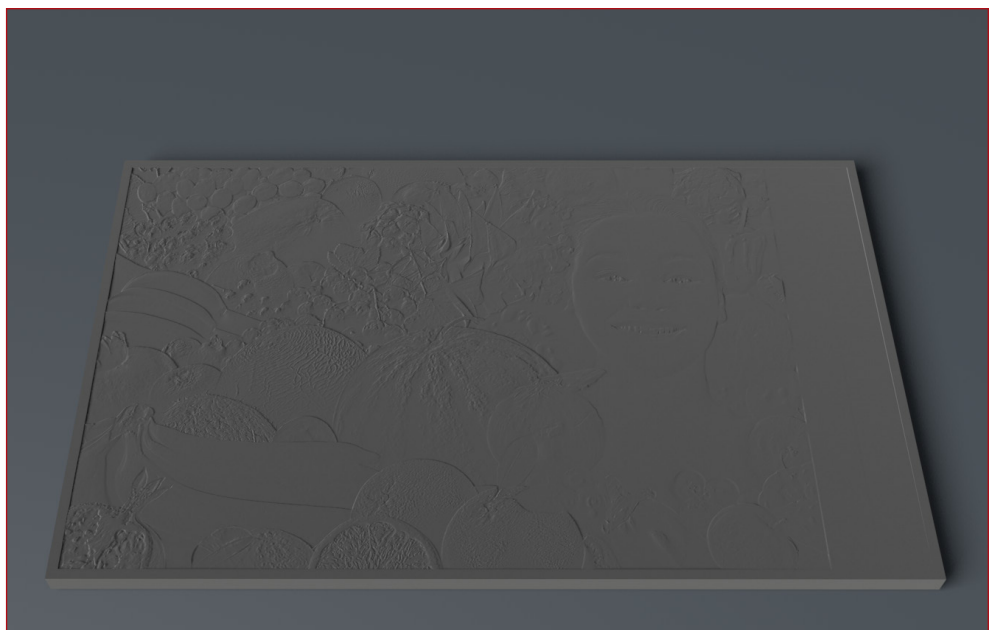

Figure 3.11 When removed from the tissue the lead sheet is trimmed back to leave a printing plate



Figure 3.12 Warm pigmented gealtine ink is poured onto the printing plate

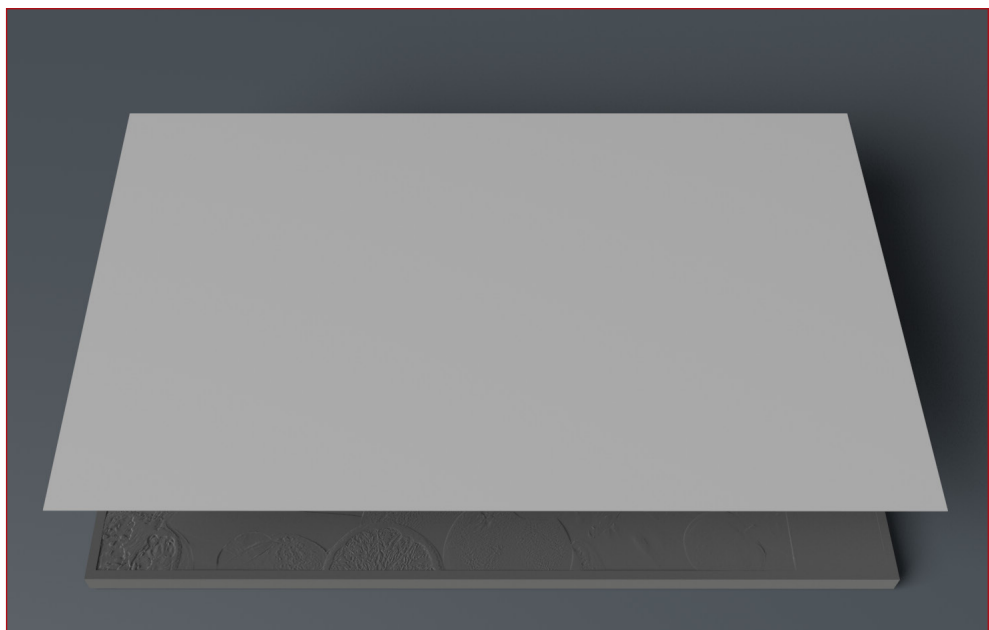

Figure 3.13 Prepared paper is placed onto the the printing plate and gentle pressue is applied

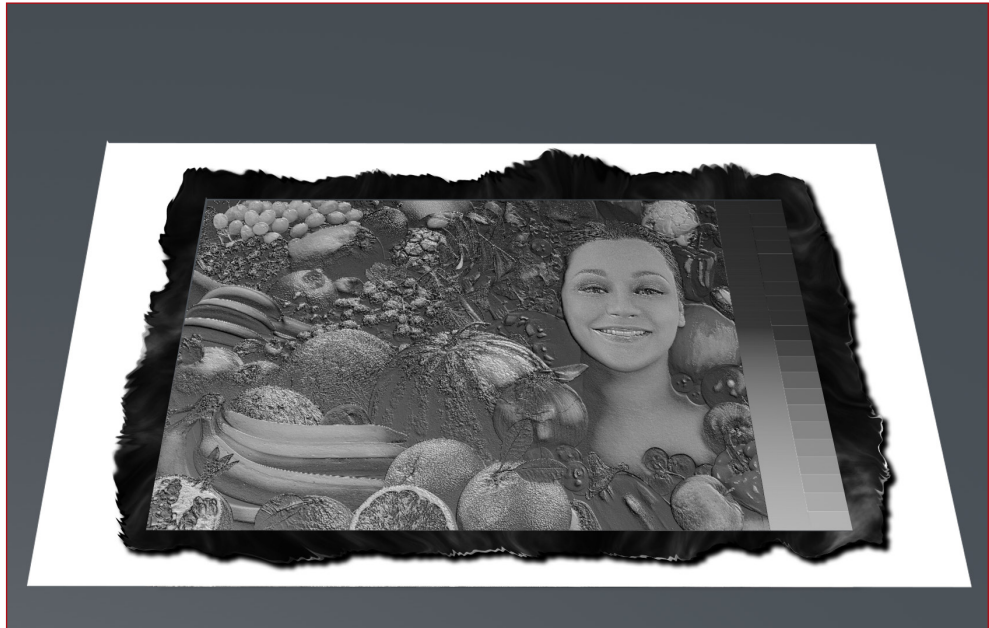

Figure 3.14 When removed from the plate the print is in high relief. Excess ink has been expelled to the edge

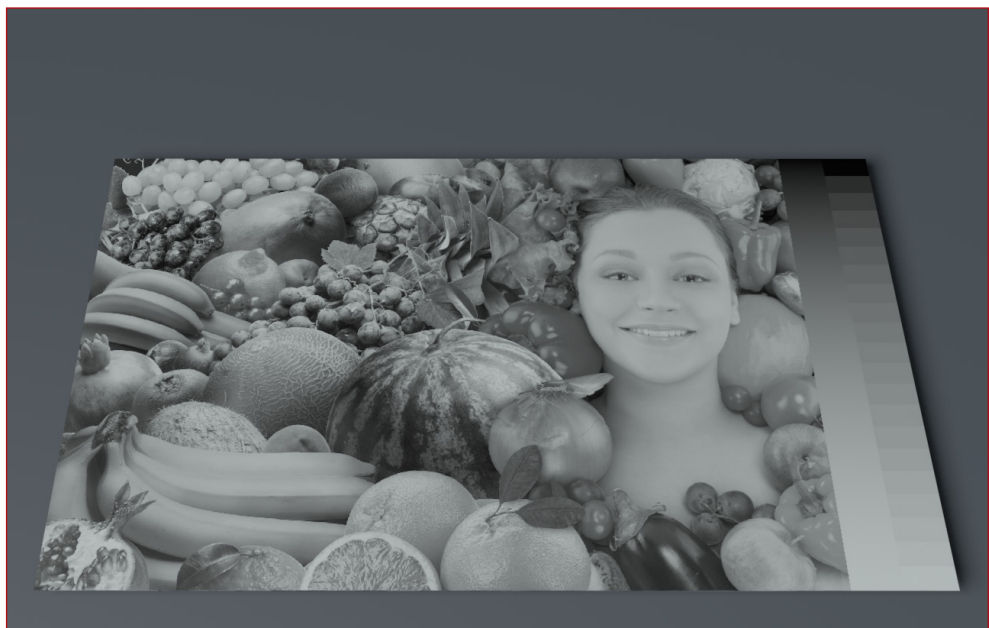

Figure 3.15 The print chemically treated and it shrinks as it dries. When dry it is cut to size and glued into the publication or “tipped-in”.

The Woodburytype and a later adaptations of the process known as Stanotype printing, have been achieved so far as single colour reproduction.

3.6 Financial advantage of commercial Woodburytype printing

The initial set up cost was greater than other photographic practices, but printed editions of Woodburytypes were cheaper to produce. For example Woodburytypes were cheaper to produce than silver prints as a result of not having to use silver and light sensitive chemicals within each print. The usual cost of three cabinet sized prints mounted on white cardboard with a white border was 2s, each (Dorking Advisor, 1889) ^[87] (£9.97 in 2015 economy) ^[88]

3.7 Industrial limitations of the Woodburytype.

3.7.1 High labour expenditure and time constraints

The Woodburytype was not without limitations (Woodbury, 1869) ^[89], it suffered from high labour expenditure, time constraints and the necessity of having to trim the image and mount it separately. This was one of the main limitations that prevented it being widely assimilated into the printing industry as it could not be successfully integrated to include letterpress on the same page (due to the excess gelatine being forced from the plate). Each image had to be manually printed, trimmed and inserted or 'tipped in' to the final publications. Woodbury had ideas on how to print with white margins (Woodbury, 1866) ^[90]. Throughout the literature survey no evidence could be found to state that this was successfully implemented within the process.

3.7.2 Hydraulic press

In order to make the lead printing plate a hydraulic press was needed to exert 4 tonnes of pressure per square inch. The size of the press needed to exert this force put restrictions on the size of printing plates that could be produced.

"...it the Woodburytype is a very ingenious and new mode of impression, but has not yet produced any large-sized pictures." (Fowler R.J. 1867) ^[91]. Commercial prints rarely exceeded 10 x 8 inches (254mm x 203mm) – 12 x 10 inches (305mm x 254mm) ^[92] in size but there are reports of prints at 11 x 9 inches (279mm x 229mm). ^[93]

⁸⁷ Anon. (1889) The Cabinet Portrait Gallery. Dorking Advisor. September 28

⁸⁸ OFFICER, L.H. and WILLIAMSON, S.H. (2016) Measuring Worth Purchasing. Power of Money in the United States from 1774 to 2010. Available from: <https://www.measuringworth.com/ukcompare/relativevalue.php> Accessed 03/06/2016.

⁸⁹ WOODBURY, W.B., 1869. Description of the Woodburytype, or Photo-relief process. The Photographic Journal, 14(March 16), pp. 4-5

⁹⁰ WOODBURY, W.B., 1866. Printing photo-relievo photographs with white margins. Photographic News, (November 9), pp. 534

⁹¹ Fowler, R.J. (24/05/1867) The History of the Processes for the Production of Permanent Photographic Pictures in Printers' Inks (Part 2). British Journal of Photography. XIV

⁹² WOODBURY, W.B., 1865. Woodbury's New Printing Process. British Journal of Photography, 12(134),

⁹³ WOODBURY, W.B., 1864. An Improved Method of Producing or Obtaining by the aid of Photography Surfaces in 'Relievo' and 'Intaglio' upon Aluminous, Vitreous, Metallic, or other suitable Materials. 2338 edn. Britain:

Groupil et Cie were able to print at 12 x 15 inches (305mm x 381mm) for 20 - 30 francs. They relied on a press that could exert 700 lbs per sq inch through a 35cm piston to produce the prints. At the time it was considered the most powerful hydraulic press in existence. (Pall Mall Gazette, 1887) ^[94]. Carbon prints did not rely on presses and the process was capable of producing prints larger than the Woodburytype. Carbon printing was the preferred method for artistic reproductions.

3.7.3 Attempts in colour

Three years after its public announcement in 1868 Louis Ducon du Hauron developed the first three colour photographic printing process, the Three Colour Carbon process. While the Carbon process had made the evolutionary leap to become tri-chromatic, Woodbury made attempts to develop colour variations of the Woodburytype called the photochrome where the three primary colours was lithoprinted onto the page and the keyline black was printed by means of the Woodburytype process on top. Other instances involved hand tinting the back of the print. The attempts to make a colour Woodburytype failed mainly due to registration problems. Woodbury himself had hesitations about attempting colour variations as he feared the black ink would muddy the vibrancy of colour when it was placed on top as a keyline (Wills & Wills, 1985) ^[95]. By the 1890s Carbon Process prints could be produced larger and in colour for artistic reproductions and the introduction of the half-tone screen enabled mass production of printed image and text.

The carbon printing process evolved into colour printing by creating individual colour separations that are exposed onto 3 sheets of bichromated gelatine in each of the three subtractive primaries. The exposed coloured gelatine would then go through a layering process where the gelatine is sandwiched together in registration using Swan's double tissue transfer method. In 1900 Paul Charles and Stephan Faujat of Frankfurt patented a machine that could reportedly fully automate the Woodburytype printing process and produce the prints in colour (see figure 14, page 19) ^[96]. There were accounts that it did in fact create beautiful colour Woodburytypes successfully, however there are no known examples of these prints or the machine in existence today ^[97]. This doctoral study in Chapter 6 will present a three colour digital Woodburytype in accurate registration.

⁹⁴ Anonymous (1887) The Home of the Photogravure, A Visit to Messrs. Boussod, Valadon, and Co. At Ansieres. - How Photographs of Pictures are Multiplied. Pall Mall Gazette. (September 29), pp.2.

⁹⁵ WILLS, C. and WILLS, D., 1985. WALTER BENTLEY WOODBURY. PHOTOGRAPHIC JOURNAL, 125(125), pp. 551-554

⁹⁶ TWYMAN, M., Printing 1770-1970 an illustrated history of its development and uses in England. London Eyre & Spottiswoode 1970.

⁹⁷ WHALE, G. and BARFIELD, N., 2001. Digital printmaking. 1 edn. London: A. & C. Black.

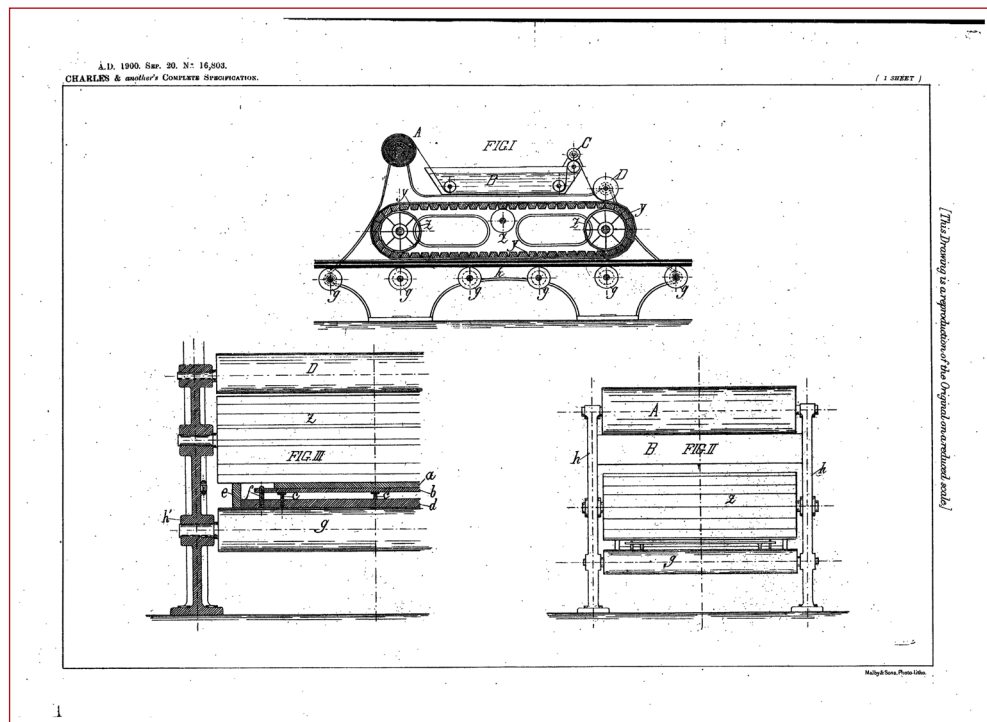

Figure 3.16 Patent 16803 - Woodburytype machine by Paul Charles and Stephan Faujat, 1900

3.7.4 Cost of investment and poor business acumen

The initial investment of equipment to create Woodburytypes was very high. A large hydraulic press capable of exerting 450 tonnes of pressure was required to create the lead plates, in 1870 this cost £156^[98] plus the cost of a licence to produce the prints. Amateur photographers and small print shops simply could not afford the initial investment. In 2015's economy, this is roughly £13,460^[99].

Poor business choices had negative financial repercussions for Woodbury. French capitalist Disdéri and Co in 1868 reportedly paid £40,000^[100] (£3,246,000 in 2015 economy^[101]) to set up a Woodburytype printing establishment. However unfortunately for Woodbury in 1869 Disdéri disappeared and there was no trace of the £40,000. The lack of payment meant that the rights transferred back to The Photo

⁹⁸ Whale, Barfield, 2001pp1510

⁹⁹ OFFICER, L.H. and WILLIAMSON, S.H. (2016) Measuring Worth Purchasing. Power of Money in the United States from 1774 to 2010. Available from: <https://www.measuringworth.com/ukcompare/relativevalue.php> Accessed 03/06/2016.

¹⁰⁰ REESE, J.J.R. and HOESEN, P.P.V.V., 2006. Maybe it's time: Making print simpleTM.

¹⁰¹ OFFICER, L.H. and WILLIAMSON, S.H. (2016) Measuring Worth Purchasing. Power of Money in the United States from 1774 to 2010. Available from: <https://www.measuringworth.com/ukcompare/relativevalue.php> Accessed 03/06/2016.

Relief Company who previously had them. Established printers Groupil et Cie paid in total 150,000f (£6,000) (£486,900 in 2015's economy) ^[102] for the rights in France. Groupil's licence conditions allowed them to re-licence the process to additional printers in France, of which Woodbury didn't get any additional fees.

By comparison the licence fee for professional photographers wanting to use Swan's process was £10 per year (£811.40 in 2015's economy ^[103]), but most sent their work off to the printing services at the Autotype Company ^[104]. More than one licence was required to commercially produce Carbon Prints in all forms, American photographers paid \$150 (£30) (£2,434 in 2015 economy) for the various licences needed to do so ^[105]. By comparison the Carbon process was much cheaper to invest in, with almost identical print results.

3.7.5 Open and closed process

When Swan's process was patented and unveiled in 1864, Mr Thomas present at the announcement stated *"that it was important to know what were the points claimed in the patent as new, as patents were generally obstructive of progress"* (Photographic Journal, 1864). ^[106]

Swan himself seems to have taken a different approach to his process than Woodbury did to his. At the process' public announcement Swan stated that putting a heavy tax would restrict its use, and he was quite averse to *"imposing any unwanted restrictions upon the experimental development of the photographic art"* (Ibid) ^[107]

It appears the public did not have easy access to modifying or adapting the Woodburytype due to patents. Even when the main patent was allowed to lapse in 1872 by the owner "The Photo Relief Company" complications in the description resulted in the process not being openly released to the public and it was retained under the patent for Swan's Mezzotint process which they also owned. As this process was almost identical to the Woodburytype, public access to the process was prevented

¹⁰² OFFICER, L.H. and WILLIAMSON, S.H. (2016) Measuring Worth Purchasing. Power of Money in the United States from 1774 to 2010. Available from: <https://www.measuringworth.com/ukcompare/relativevalue.php> Accessed 03/06/2016.

¹⁰³ OFFICER, L.H. and WILLIAMSON, S.H. (2016) Measuring Worth Purchasing. Power of Money in the United States from 1774 to 2010. Available from: <https://www.measuringworth.com/ukcompare/relativevalue.php> Accessed 03/06/2016.

¹⁰⁴ GERNESHEIM, H. and GERNESHEIM, A. (1987) The History of Photography Volume II. the Rise of Photography 1850-1880. the Age of Collodion. 3rd ed. London: Thames and Hudson. Pp263

¹⁰⁵ OFFICER, L.H. and WILLIAMSON, S.H. (2016) Measuring Worth Purchasing. Power of Money in the United States from 1774 to 2010. Available from: <https://www.measuringworth.com/ukcompare/relativevalue.php> Accessed 03/06/2016.

¹⁰⁶ Journal, P. (1864) A New Method of Carbon Printing. The Photographic Journal. (April 15), pp.20-25.

¹⁰⁷ Journal, P. (1864) A New Method of Carbon Printing. The Photographic Journal. (April 15), pp.20-25.

and the loop remained closed. By 1896 the Woodburytype was not as popular as it had been. Practitioners no longer needed a license to use the process, but it was very difficult to get lead clichés (lead printing plates) made commercially at this time. (Photographic Journal, 1896) ^[108]

3.7.6 Fixation and isolation

Walter Woodbury devoted himself completely to solving problems related to his processes, but it appeared that he did so mostly on his own. Every change he made to the process resulted in new patents, which were modifications of the existing ones. His last modification to the process was the Stanotype Process (Woodbury, 1880) ^[109], which came seventeen years after his first patent on the process. Working in isolation may have hindered the progress of his printing process.

Poor business choices in seeking to sell exclusivity rights to the process, filing multiple patents before any money could be recuperated from previous iterations of the process (Crawford, 1979)^[110], and the lengthy legal costs to protect his process, resulted in financial difficulty. This combined with a long period of poor health resulted in a charity collection being set up for Woodbury by means of a subscription committee (The Photographic Journal, 1885)^[111], of approx. £400 (£38,970 in 2015 economy) ^[112] with the Manchester Photographic Society donating 50 guineas (£5,086 in 2015 economy) ^[113].

3.7.7 Health and later years

Woodbury worked with many highly toxic chemicals in the chemistry of photography. Woodbury noted that his eyesight deteriorated rapidly specifically his centre of vision which was obscured with a glare or spot, and he wondered if it was due to experimenting with arc lights. (The Yearbook of Photography and Photographic News Almanac, 1883) ^[114].

¹⁰⁸ Journal, P. (1896) Answers to Correspondents. British Journal of Photography. (January 17), pp.48.

¹⁰⁹ WOODBURY, W.B. (1880) Woodbury's New Photoglypic Process. British Journal of Photography. 27 (May 14), pp.233.

¹¹⁰ CRAWFORD, W. (1979) The Keepers of Light. A History & Working Guide to Early Photographic Processes. 1st ed. New York: Morgan & Morgan Ltd. Pp289

¹¹¹ Unknown (1885) WB Woodbury Fund. The Photographic Journal. 25 (Vol IX) (April 24), pp.126.

¹¹² OFFICER, L.H. and WILLIAMSON, S.H. (2016) Measuring Worth Purchasing. Power of Money in the United States from 1774 to 2010. Available from: <https://www.measuringworth.com/ukcompare/relativevalue.php> Accessed 03/06/2016.

¹¹³ OFFICER, L.H. and WILLIAMSON, S.H. (2016) Measuring Worth Purchasing. Power of Money in the United States from 1774 to 2010. Available from: <https://www.measuringworth.com/ukcompare/relativevalue.php> Accessed 03/06/2016.

¹¹⁴ Unknown (1883) The Yearbook of Photography and Photographic News Almanac for 1883 . . pp.87.

Reports came later after his death that he did nearly destroy his eye-sight staring into a carbon arc light (The Photographic Journal, 1888)^[115].

It is not the first time that Woodbury may have been involved in unsafe practice. One article states that Woodbury was experimenting with the same phosphorescent mixture used by French luminous watch dial makers. "The Graphic" (1879) gives an account of a demonstration by Woodbury where he is handling the mixture as a dust and coating card with it to be used as a backing material for glass photographic positives. It describes how Woodbury uses the warmth of his fingers to increase the luminance of the image. ^[116]

Radium, a commonly used radioactive illuminescence for watch dials, wasn't discovered until 1908 by Marie Curie. It is known that other radioactive chemicals such as uranium, pitchblende, and torbernite were being mined in Cornwall in the UK and used to colour glass and pottery and also in the production of photographic chemicals from about 1830. (Harvie, 1999) ^[117].

Woodbury died at the age of 51 while visiting Margate with his two youngest daughters. He had been in declining health and was suffering for the last year with diabetes. He had been depressed at the time of his death and was drinking more than he should, up to a bottle of brandy a day. It was believed he began excessively drinking in Java and Singapore and continued on his return to England, although he was never seen drunk. His finances were said to have improved, and were good, with prospects on the up as he had sold a patent days before his death. Years previous to this, when he was having financial difficulties he said that he was tired of life. Lately he had become restless and unable to sleep, and was known to regularly take laudanum (an opiate containing morphine and codeine), although he said it had no effect on him. On the night of his death he was seen drinking a brown liquid from a tumbler (Whitstable Times and Herne Bay Herald, 1885). ^[118]

115 Unknown (1888) Tuesday, August 28th, 1888. J.Traill, Taylor, Member of Council, in the Chair. The Photographic Journal. 29 (November 30), pp.19-20.

116 Anon. (1879) Scientific Notes. The Graphic. May 31 , 530.

117 HARVIE, D., I. (1999) The radium century. Endeavour. 23 (3), pp.100-105.

118 Unknown. (1885) Poisoning by an overdose of laudanum. Whitstable Times and Herne Bay Herald. , 5.

He died from a laudanum overdose which he took to help him sleep. (Leeds Mercury, 1885)^[119] There was not sufficient evidence to suggest that the overdose was accidental or otherwise. (Manchester Courier and Lancashire General, 1885)^[120]. Woodbury was buried on Saturday 12 September 1885 in Abney Park Cemetary , Stoke Newington. (Manchester Courier and Lancashire General, 1885).^[121]

After his death in 1885 the gross value of his personal estate was said to be £240, (£22,560 in 2015 economy)^[122] (Royal Photographic Society, 2008)^[123].

3.8 In summary

When presented in a linear fashion it is clear to see that many processes lead to the invention of the Woodburytype. It is apparent that the process itself is a hybrid combination of several photographic and photo-mechanical methods. It is very closely related to the carbon process and many of the steps of both processes are identical.

While the initial objective of the Woodburytype was to permanently and mechanically produce photographic images, the textural qualities in how it achieved this is what is of interest to this study's contribution to knowledge. By translating photographic tones into a physical height the process developed a method of image translation for mechanical reproduction parallel to other methods of that time that were looking at half-tone screen translation processes.

Woodbury's process was more suited at a craft and artistic level of output and only for the highest level of reproduction and quality publications such as *Street Life of London* (Thompson, Smith 1876–7).^[124] It was not suitable for the industrialisation of the 1800s.

¹¹⁹ Anon. (1885) Literary and art gossip. The Leeds Mercury. Monday September 28 , 3.

¹²⁰ Anon. (1885) Sudden death of Mr. Walter Woodbury. Manchester Courier and Lancashire General Advertiser. Tuesday September 08 , 6.

¹²¹ Anon. (1885) The Late Mr. W. B. Woodbury. Manchester Courier and Lancashire General Advertiser. Tuesday 15 September , 7.

¹²² OFFICER, L.H. and WILLIAMSON, S.H. (2016) Measuring Worth Purchasing. Power of Money in the United States from 1774 to 2010. Available from: <https://www.measuringworth.com/ukcompare/relativevalue.php> Accessed 03/06/2016.

¹²³ The Royal Photographic Society,Victorian Chapter (2008) Walter Woodbury. A Victorian Study. 1st ed. Melbourne, Australia: RPS Victorian Chapter. Woodbury's last years, Elliott, Alan pp104-105

¹²⁴ THOMPSON, John; Smith, Adolphe (1876–7) Sampson Low, Marston, Searle and Rivington, London

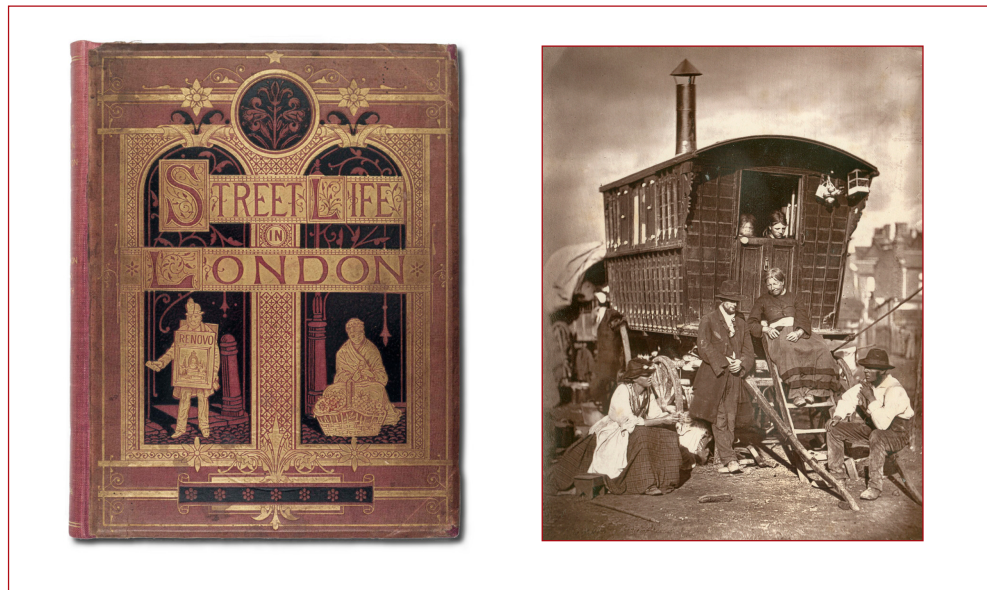

Figure 3.17 Street Life of London (1876) and “London Nomades” Woodburytype. Used under a Creative Commons Attribution-NonCommercial-ShareAlike (CC BY-NC-SA 3.0). LSE Library collections. <https://digital.library.lse.ac.uk/collections/streetlifeinlondon>

In comparison of the business models behind the two processes, Swan’s Carbon process was an open process freely accessible to all hobbyists and amateurs, while professionals were required to purchase a license. He actively became involved in the manufacture and supply of materials needed to follow his process, and the distribution and licenced use of his tissue by the Autotype Company (Gernshien & Gernsheim, 1955)^[125]. Woodbury on the other hand made his process inaccessible to the average user with high start-up costs (Hannavy, 2008)^[126]. The requirement of a hydraulic press to make the clichés and a closed process stifled the development and evolution of his printing methodology as the technology changed.

3.8.1 Next Chapter - Chapter 4

Chapter 4 recreates the Woodburytype process through an empirical investigation to gain practical knowledge and better understanding of the process. The findings are described, discussed and explored with empirical observations.

¹²⁵ GERNDSHEIM, H. and Gernsheim, A. (1955) The History of Photography. from the Earliest use of the Camera Obscura in the Eleventh Century Up to 1914. 1st ed. London: Oxford University Press. p276

¹²⁶ HANNAVY, J., ed. (2008) Encyclopedia of Nineteenth-Century Photography Volume 1 A-I . Taylor & Francis group. Pp1511

4 Gaining historical knowledge through the reassessment of the Woodburytype process

Synopsis: This chapter is the output from the historical literature survey. The aim of the chapter is to collate existing historical knowledge into a working method with the objective that future practitioners can then replicate it. What differentiates this study from other contemporary writings on the subject is that it identifies gaps within the historical source material and bridges the knowledge by testing their claims. This is achieved through an empirical study. The results are described as written documentation and the observations are presented as photographic illustrations.

4.1 The relevance of this Woodburytype study

So that research could present the Woodburytype process, over 280 articles from original photographic journals, annuals, notes and patents from 1864 to 1902 were assessed. This spans the 38 year period during the three main stages of the process' lifespan: infancy, maturity and decline from the printing world. What this historical study of the process aims to do is to state in detail the procedural workings of the Woodburytype process in depth enabling it to be practically re-created in contrast to providing only a basic historical account. Observations from empirical investigation are included in this chapter. This bridges the gaps identified from the partial accounts of the 19th century, allowing for a richer base knowledge of the process through the empirical observations. A few select publications are used to reference within this chapter, it must be stressed that a full set of recipes, and a Woodburytype specific bibliography, timeline of key Woodburytype events are presented in Appendix 4.

This chapter identifies the main variations and optional steps within the stages of the Woodburytype process. It consequently demonstrates and evaluates the procedural effect they have within the process.

It was observed in the literature survey that historical summaries became the basis for most contemporary descriptions of the process, with little or few descriptions of 21st century empirical accounts. Through each iteration, these accounts became more diluted with generalisations and lack attention to detail. Contemporary descriptions

recite limited practical and functional information. Complete details of the process are dispersed across historical journals, more often than not these are presented in a fragmented form published over several issues. Historical notes provide limited reasons for specific procedural workings and the contemporary synopses lack the attention to detail and prevent the knowledge needed for a functioning method.

I believe this is due to the redundancy of the process; the level of detail is no longer required, as the means to complete the process are not readily available. Describing a generic method enables easy digestion of information for the modern reader who does not need great detail but only a functional base knowledge and a simple understanding of the process.

What distinguishes this research within the present thesis is that it collates, examines and assesses as many functioning historical descriptions of the process as practically possible. These are taken from partial and complete accounts published between 1864 and 1902. These provide more reliable accounts as these are the known working models. Through an empirical evaluation of the process this study can deduce areas that are missing in past historical research and attempts to join the dots between the partial accounts. It is anticipated that as photographic archives become more accessible through conservational digitisation, and with the growing interest in the Woodburytype process, the knowledge will continue to grow collectively.

4.2 The information within this chapter will be presented as follows:

4.2.1 Stages

The process will be described in a series of stages. Each stage demonstrates the procedures that must be completed from start to finish so that additional stages can proceed. Some stages can be prepared in advance independently, while others are interdependent.

4.2.2 Steps

Stages are sub-divided into steps. Steps are smaller tasks that are executed in linear workflow allowing for a stage to be complete. Some steps are optional and may be completed at the printmaker's discretion. Other steps are mandatory and must be completed to facilitate a stage being executed successfully.

4.2.3 Summary

A summary of each stage will be presented in the form of a flow-diagram that demonstrates the connectivity of the steps and their interdependence.

Through the presentation of information in this manner it is aimed that a holistic understanding of the method will be created. It will be observed that nuances in the

descriptions create variations with sometimes extremely noticeable effects on the workflow and results.

4.3 The Woodburytype process.

The Woodburytype process consists of eight key stages each comprising of specific individual steps. The first four of the stages are almost identical to the carbon process. A basic knowledge of photographic practices and the dark room are required for the first four stages of the process. The eight stages are listed below.

4.3.1 Photographic input image

The various methods of producing a photographic input image are depicted.

4.3.2 Tissue manufacture & sensitising

The steps to produce and store the gelatine tissue are tested and illustrated.

4.3.3 Photographic exposure

The details of transferring a photographic image from a negative to form the latent relief within the gelatine tissue is explained in this description.

4.3.4 Developing process

'Washing out' or developing the exposure is demonstrated in this section. This stage produces a master print matrix from which printing plates can be produced.

4.3.5 Printing plate generation

The three core methods of producing Woodburytype printing plates, through electrodeposition, impression by force and casting are described here.

4.3.6 Receiving substrate

This stage involves the preparation of substrates that are suitable for receiving the prints.

4.3.7 Printing process

The types of presses that were suitable for producing Woodburytype prints are described. Modern alternatives and make-shift variants are addressed. Details on how to pull the prints are discussed.

4.3.8 Print finishing

The final steps that finish the process ensuring preservation and protection from moisture are explained.

The technical awareness of the process will be an advantage in the planning of print production. Specific steps in early stages have the ability to increase the number of technical limitations in later stages. These may have an impediment on the final printed image. It has been stated already in this research that the Woodburytype and the Carbon print are very similar in certain stages. To understand the Woodburytype one must also understand the Carbon process, thereby expanding the knowledge necessary for the first four stages of the Woodburytype.

It was found to be advantageous to learn the Carbon transfer process and producing artefacts through it before attempting the Woodburytype process. This initial learning of an existing process provided a grounded knowledge in the first four stages of the Woodburytype process in working with, sensitising and exposing gelatine tissues. The results of the Carbon printing trials are documented in Appendix 4. Visual comparison between the prints is presented in Chapter 6

4.4 Risk management and identifying areas of knowledge.

The Johari Window was initially developed by psychologists Luft and Harrington (1955) as a tool for solving heuristic exercises. It is a tool that has often been adapted for risk management. The window is a table consisting of four quadrants. Each quadrant depicts the knowledge available in varying states of awareness. This research used the model to identify the gaps in knowledge and where risk of failure would most likely arise.

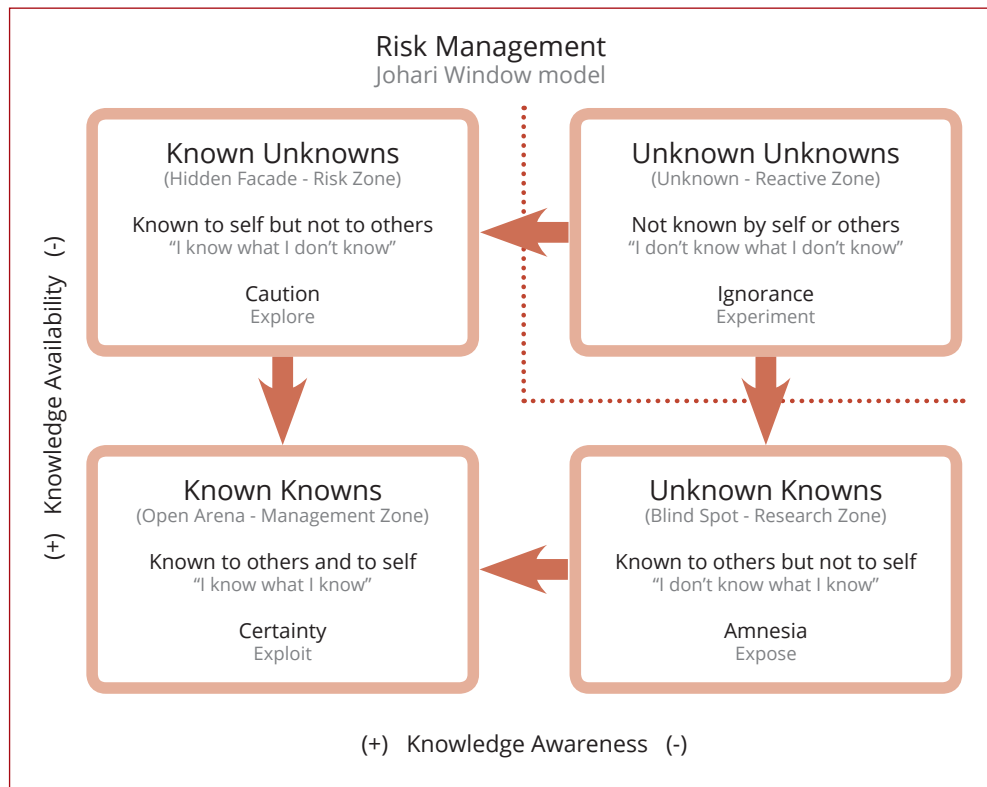

Figure 4.1 Johari window for risk management

- Known Knowns** These are areas of certainty and proven existing knowledge. This is an area open to all in a general arena that can be exploited. It contains knowledge and ability demonstrated to a high level of proficiency. This is the knowledge identified within the literature survey.
- Known Unknowns** This is a low risk area. It has been identified as areas of knowledge that can be developed further and moved into the known known quadrant of high proficiency. This area is developed further through empirical investigation.
- Unknowns Knowns** This is a high risk area, a blind spot has been identified in the research or knowledge. This quadrant represents the gaps in knowledge that have been identified and that need to be reconnected. It will be developed through action research and the knowledge will transition into the known knowns.
- Unknown Unknowns** This is an unconscious area of unknown knowledge, this is the quadrant that will be later identified in Chapter 7 in the conclusion and areas for further research.

4.4.1 Historical literature surveys

When all of the information is presented chronologically this should ideally provide a linear progression of discoveries, improvements, and key stages in the lifecycle of a process or event. These are the known known areas of knowledge. This timeline of known developments should in ideal circumstances allow a process to be completed from the beginning stages to the final steps – in this instance, from the initial photographic negative through to the final physical print. Difficulties arose when assessing the data contained in the documentation of the Woodburytype. The specific details of the process are spread across many articles and journals. Most articles give differing details of the procedure. One specific description that gave the most complete version of the process was contained over six parts. This information again varied from other descriptions. In the attainment of knowledge for this processes there were two certainties that remained the same throughout – an initial starting point of an input image and a finite end point with a physical print. What links the two absolute stages is variable data from a multitude of sources.

Eight milestones were identified within the process. These are the stages that must be completed so that another stage can progress. The eight stages form the basis of empirical investigation. In conjunction with the literature available the stages provide a framework for a specific empirical investigation where the desired outcome is already known and what is to be expected prior to the investigation beginning. They should be a matter of repeating or replicating practical stages so that the results can be confirmed or refuted.

In each of the stages there may be details or in-between steps that may be complete, missing, or conflicting with other reports. Herein lie the identified gaps in knowledge that are classed as “known unknowns and unknown knowns”. Through an empirical investigation initiation, the observations will be analysed and through cycles of action research. This research method enables change to occur through a bottom up approach, in this instance reverse engineering the problem and working backwards to the starting point.

The purpose of this chapter and the next is to move as much knowledge as possible into an “open arena”. The unconscious area of unknown unknowns will be later discussed in the areas for further research in Chapter 7.

4.4.2 Knowing the limitations of the process

Knowing the limitations is essential in managing the expectations. Processes that rely heavily on technology must be able to adapt or upgrade or they will quite possibly become obsolete. The Woodburytype is a process heavily burdened with technological limitations. Many of these restrictions are imposed upon it by its own methods, which made it impractical once other printing methods became available.

4.5 Stage 1 - Photographic input image

The initial stage of the Woodburytype process begins with creating a photographic negative or positive^[1], which is used as an input image. A negative is a term given to an image where the lights and shades are reversed. A positive is a term given to an image where the lights and shades are represented as they are seen in nature. Negatives were initially made through gelatino-bromide (dryplate) or collodion processes (wetplate)^[2]. The wetplate collodion process could also produce positive images through a variation of the original process^[3].

Irrespective of whether the input image is a positive or a negative it is contact printed against a photosensitive tissue, which receives the image. Eventually this becomes the print matrix from which the printing plates are made. The negative (or positive) because it is contact printed determines the final print size. Large negatives enabled large contact prints and small negatives allowed for small contact prints. The generation of the negative was seen as a very important stage within the process. Any imperfections in the negative will be transferred to the print matrix. The negatives must therefore be generated in the best conditions^[4] to ascertain the best prints.

-
- 1 Woodbury, W. B. (12/05/1865) New Patent: Complete Specification of Patent Obtained by Walter Bently Woodbury, Manchester, filed 23rd March, 1865. *British Journal of Photography*. XII
 - 2 WOODBURY, W.E., 01/01/1898. Stannotype. *The Encyclopaedic Dictionary of Photography*,
 - 3 HANNAVY, J., ed, 2008. *Encyclopedia of Nineteenth-Century Photography*. 1 edn. USA: Routledge.
 - 4 Tissandier, G. (01/01/1876) *A History and Handbook of Photography (Part II, Chapter II)*. *A History and Handbook of Photography*.

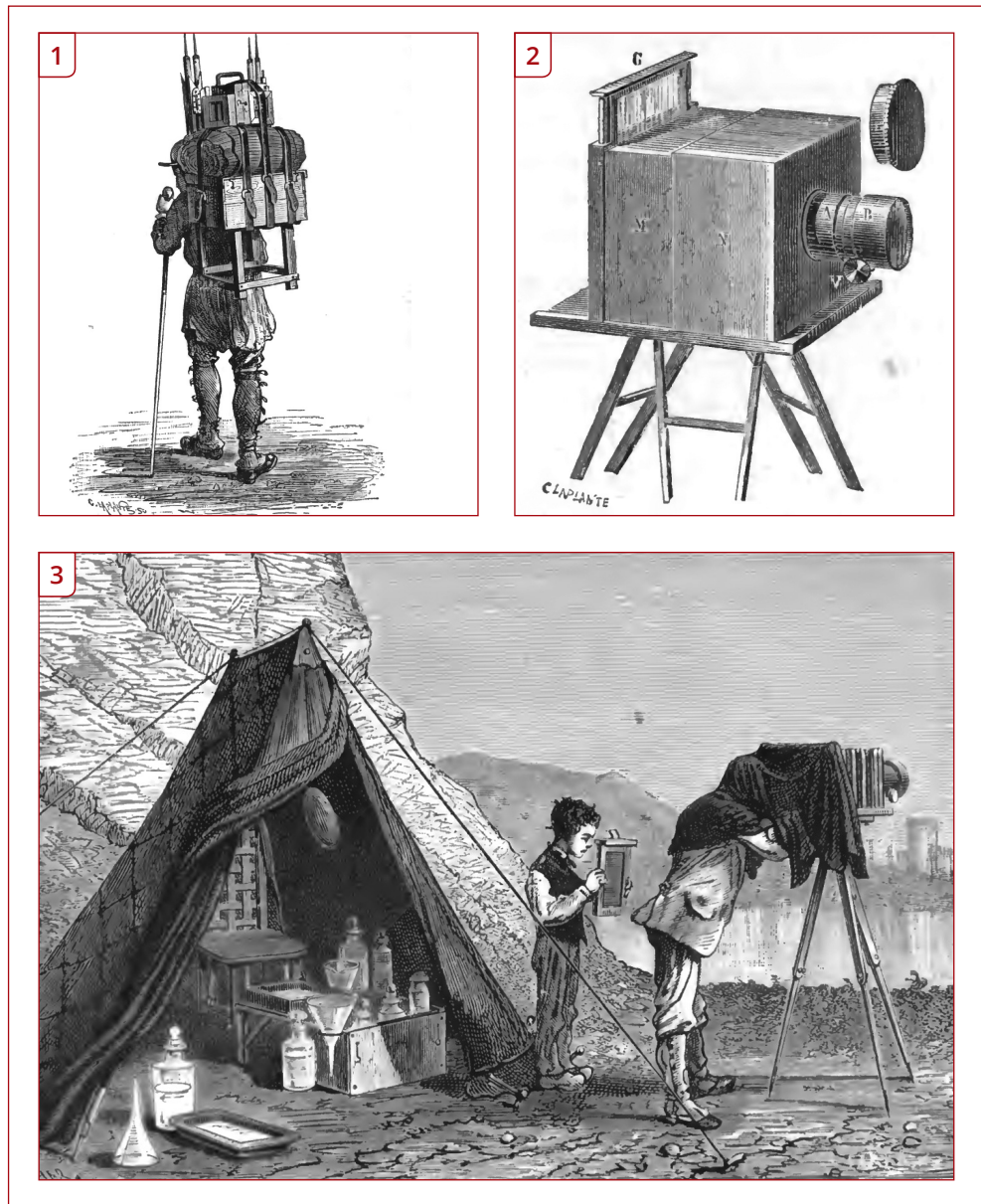

Figure 4.2 1) Field photography kit 2) Wet-plate camera 3) Field dark room
Published in *A History and Handbook of Photography*, TISSANDIER, Gaston (1877)

The negative typically was a photographic image taken from nature. Portraits and landscapes were generally produced with the process however early descriptions mention that other artistic work^[5] could be presented too. Two methods were described for the reproduction of works of art. The first was to take a photographic capture of an artist's existing painting or drawing^[6]. The second method was to physically paint a matrix (Woodbury 1870)^[7] and is was similar to the method described by George Wallis for his Autotypography process.

4.5.1 Tonal ranges

The photographic method employed for creating an input image at the time of the process' conception would have been a negative generated by the collodion wet plate process. "Soft negatives" were initially perceived to be the most preferred method provided that all of the tonal ranges and details were in the negative. Later, descriptions of using "dense or vigorous"^[8] negatives became the standard practice. "Dry plate" or "thin" negatives could be used provided that negatives produced by this method were intensified^[9] so that they could be used successfully. This also enforces the suggestion that denser negatives had become the standard practice. By 1896 it was stated that 'ordinary negatives' were being used with no other additional information. While this is not explained any further in Woodburytype articles, several carbon tissue sensitizer recipes state that the density of the negative does effect the sensitizer strength and the times needed to make the photosensitive tissue. Soft or thin negatives are those with a low density. A weak negative, in which the silver deposit is somewhat light in tone and the shadows are transparent, will appear as a positive when viewed against a black background,^[10] These negatives required a tissue that had a shorter sensitising time in a lower strength sensitising bath. Conversely dense vigorous negatives with a high density required the opposite, longer times in a higher percentage of sensitizer. The method of producing negatives evolved with the technological advancements photography in general, and so did the input image method for the Woodburytype.

The empirical investigations used a series of negatives and positives from different sources (Epson, Cannon, Roland, Polaroid). As well as sourcing a traditional negative from 1900c, a range of digital printers were used to produce input images. These were

-
- 5 Unknown (20/10/1865) The New Printing Process - A Day With Mr. Woodbury. British Journal of Photography. XII
 - 6 Sutton, T. (01/03/1870) A Week at the Woodbury - Printing Establishment of MM. Goupil at Ansieres, near Paris. The Photographic Art Journal.
 - 7 Woodbury, W. B. (25/02/1870) Recent Patents - Photo-Relief Printing. Photographic News. XIV
 - 8 Unknown (13/04/1893) Extract - Messrs. Waterlow & Sons' Photo-Mechanical Printing Works. British & Colonial Printer & Stationer. XXXI
 - 9 Unknown (13/04/1893) Extract - Messrs. Waterlow & Sons' Photo-Mechanical Printing Works. British & Colonial Printer & Stationer. XXXI
 - 10 Newhall, B. (1964) The History of Photography. 1st ed. New York: The Museum of Modern Art, New York.

both contone and digital half-tone outputs. I put little emphasis on the genus of the negative. As the original process adapted to use different negatives it stands to reason that it should also be adaptable now. The research at the CFPR by Thirkell (2000)^[11] also exposed half-tone negatives to generate continuous-tone gelatine reliefs by employing acetate sheets to difuse the pattern during exposure.



Figure 4.3 Four Photographs taken with permission during a wet plate collodion demonstration by Michael Schaaf as part of photographic conference. 1) Bellows camera used for image capture 2) Framing the shot before exposing the wet plate 3) Glass plate during the developing stage 4) The final developed image.

¹¹ THIRKELL, P., 2000. The integration of digitally mediated imaging techniques with 19th century continuous tone printing processes Paul Thirkell, University of the West of England

4.5.2 Positive or negative images.

Depending on how the printing plate is produced in 4.16 will dictate whether an initial photographic “negative” or “positive” image is required. This can cause confusion when referencing between early and later descriptions of the process as the method of plate production changes slightly throughout the life span of the process. For most purposes a negative is required, however be aware that variations of making electrotyped plates and late iterations of the process (Woodburys last variation of the process, the Stanotype) may require a positive image or a reversed negative ^[12]. In some instances, it was stated that the correct orientation of the image could be achieved by flipping the gelatine matrix on the hydraulic press in the later stages of plate manufacture ^[13]. From the reliefs produced in this study this method of correcting the orientation of the printing plate was not possible.



Figure 4.4 1) Positive test image 2) Negative test image

Source: [istock.com/mihhailov](https://www.istock.com/mihhailov) and [istock.com/ValentyVolkov](https://www.istock.com/ValentyVolkov)

4.5.3 Enlarging and reducing sizes

If a change in print size was required the original negative had to go through a process of being enlarged or reduced in size. This additional process generated a reverse negative or a positive that was at the desired size. This new “positive” then underwent a “positive to negative” translation that generated a new photographic “negative” also at the desired size. More than one method can be used to generate a reverse negative. Depending on the method used to produce the original this ranged from re-photographing the “negative / positive” to chemically treating the negative to make it appear reversed. Whatever the method chosen by the photographer, it was described as being fine, provided that the final negative was dense and suitable for use.

¹² Unknown (05/02/1869) Herr Albert's New Mechanical Printing Process. *Photographic News*. XIII

¹³ Unknown (01/06/1870) Editorial. *The Photographic Art Journal*.

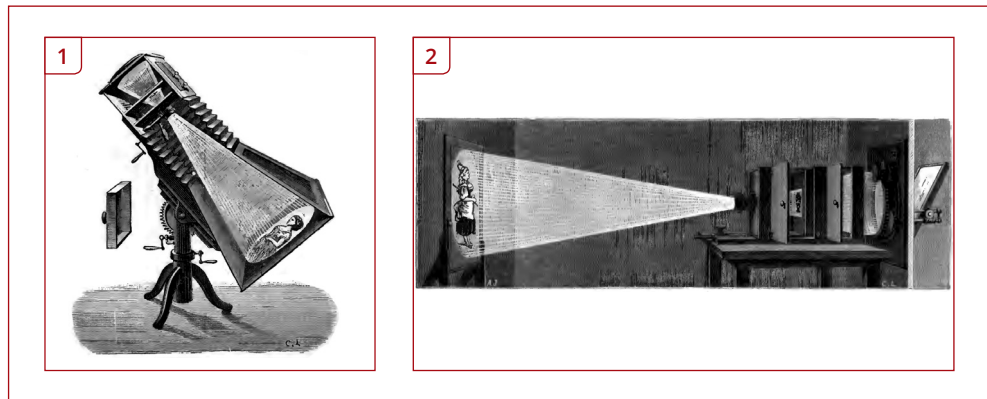

Figure 4.5 Photographic enlarger, published in *A History and Handbook of Photography*, TISSANDIER, Gaston (1877)

This process is somewhat easier with digital technology where the image file can be changed through software applications like Adobe Photoshop or simply processed at a different size through RIP stations such as ONYX or Caldera. It would be best practice to have an image appropriate pixel information and bit depth (explained in Chapter 5) that would allow for enlargement.

4.5.4 Framing the image

Images produced by wet plate collodion have mottled edges and can be seen in Figure 4.3. A framing matt or opaque border is placed upon the negative so that approximately 1/8" around the edge will be masked off. This frames the image giving it sharp defined edges. This framing is important in the later stages of exposure and development, but was not commonly discussed in Woodburytype articles about its advantages. It appears to be a common feature in Carbon printing.

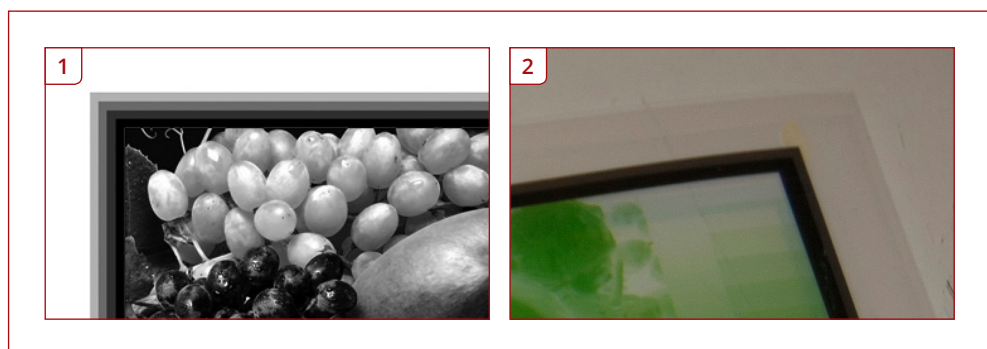

Figure 4.6 1) Framed edge on digital file 2) Framed edge on physical negative

Two methods of framing the image were tested. While both worked one was preferred

more than the other. A framing mat made from black 220 gsm card was cut to fit the negative but be smaller than the gelatine tissue. The second method involved designing the frame into the digital negative file before printing. As the majority of negatives in this study were from a digital source this method was the most flexible.

Allowing the tissue to be larger than the frame allowed for an area outside of the image to be exposed. This generated a small moat or trench in the unexposed areas when developing and protecting the gelatine exposure during the development. It did this by preventing water getting under the edge of the tissue and lifting it up. Once developed the sacrificial outer frame could be removed by peeling it away from the wash support. The framed edge allowed for a more focused use of flowing water on specific areas in developing the image and a higher degree of agitation during the development. The incidence of frilling (Figure 4.38) on the edges was greatly reduced with the inclusion of a wash out frame.

4.5.5 Size restrictions

The size of the final print is dependent on two factors: the size of the initial negative used to contact print and generate the print matrix, and secondly the method employed to make the printing plates. At this early stage of the process knowing what size the printing plates can be generated will allow for the optimum size of negatives to be produced. Large negatives can always be reduced, but there will be an upper limit on the amount of enlarging that can be done without compromising image quality particularly with digital files.

Certain professional practitioners such as MM Goupil et Cie. in Paris had the necessary resources readily at their disposal. The result being they could produce whole plate negatives between 10"x8" ^[14] up to 12"x15" that were fit for purpose without additional re-sizing steps thus allowing for them to generate larger sized prints. Smaller establishments and hobbyist photographers could realistically expect to produce prints 3.25" x 4.5" or quarter plate in size (or smaller) as they generally did not have the resources available to generate the printing plates at a large size.

Plates manufactured by hydraulic impression are restricted in size by the force that can be delivered by the hydraulic press. UWE Bristol has a 200KN hydraulic press used for concrete stress testing within its Faculty of Environment and Technology (FET). This is the maximum force that the hydraulic press being used in the empirical tests can produce. The area of the printing plates can be calculated to achieve the desired pressure per square inch required to successfully make the printing plates.

¹⁴ Sutton, T. (01/03/1870) A Week at the Woodbury - Printing Establishment of MM. Goupil at Ansieres, near Paris. The Photographic Art Journal.

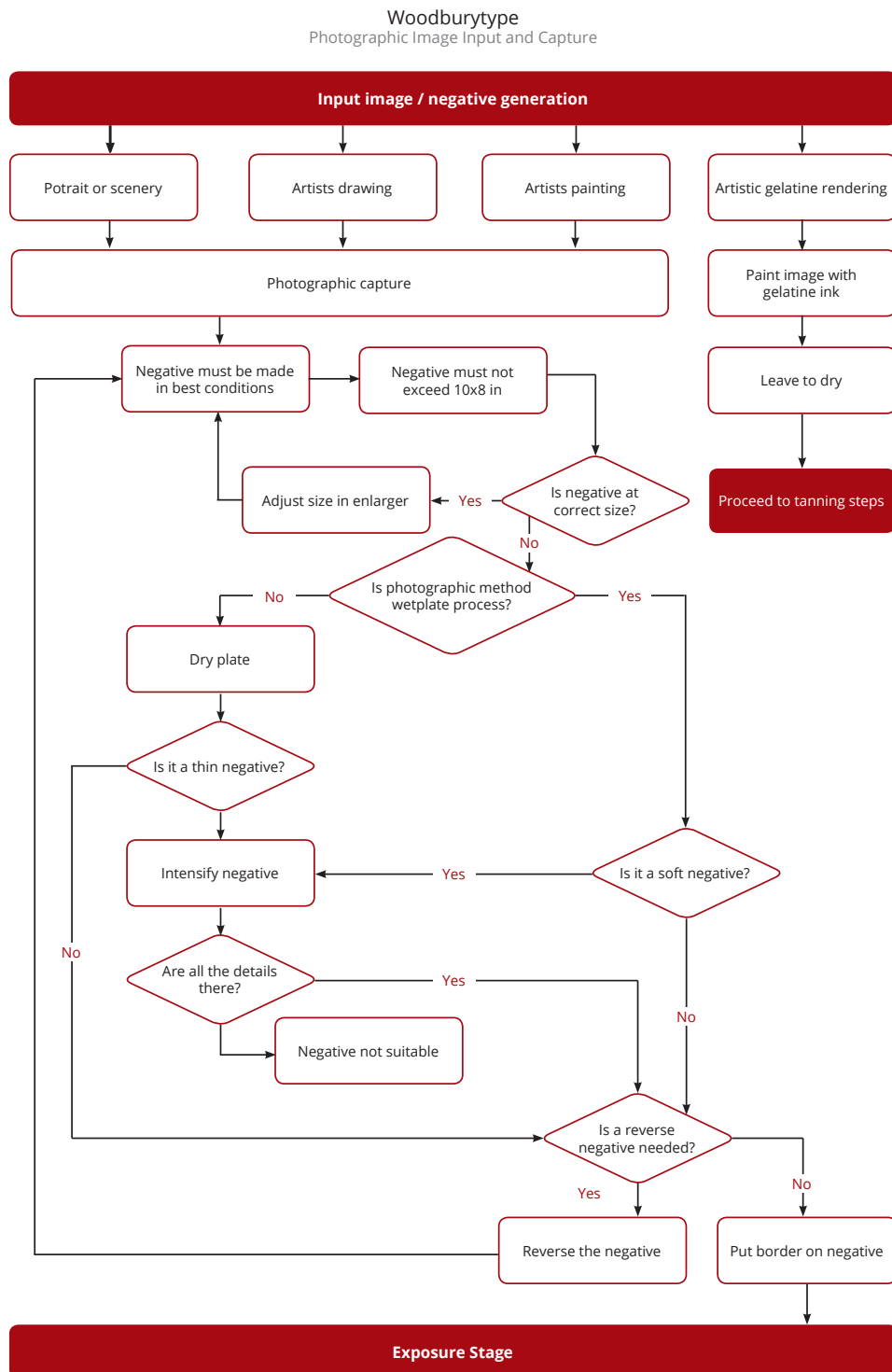

Figure 4.7 Photographic Image Input

4.6 Stage 2 - Photographic tissue generation

A photosensitive gelatine tissue is required to generate a relief image matrix. From the matrix, intaglio printing plates can then be made. The general principle for creating the tissue starts by pouring or casting warm gelatine in a process called “spreading” upon a series of supports and resists in a manner almost identical to creating extra thick tissues for carbon printing. Different types of supports and resists are needed at different stages for different reasons. They allow for tissue production, protection of photographic negatives, preventing holes, and distortion of the matrix. Tissue was spread as a large sheet and then trimmed to the desired size for use.

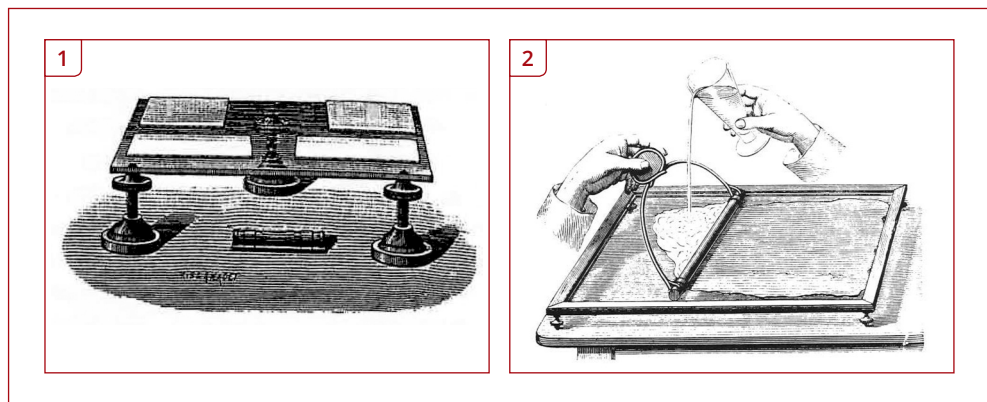

Figure 4.8 Levelling stand with glass plates, published in *La photographie, traité théorique et pratique*, Davanne, A. (1886) 2 casting gelatine tissues using a coating rod and frame

4.6.1 Spreading support

A support is used in the spreading of the gelatine tissue to ensure that a flat, even and smooth surface tissues are produced. This is crucial for the photographic exposure. This stage always starts with a regular glass plate, regardless of final support used in spreading (Woodbury 1865).^[15]

4.6.2 Traditional spreading supports

4.6.3 Glass plate support

A glass casting support is used in the preparation of the tissue^[16]. The glass plate is treated and prepared before use^[17]. The glass must be clean and free from dirt, dust,

¹⁵ Woodbury, W.B. (18/08/1865) The New Photo-Relief Printing Process In Semi-Transparent Ink. *Photographic News*. IX

¹⁶ Woodbury, W.B. (1870) Improvements in Photo-Press Printing. *British Journal Photographic Almanac and Photographer's Daily Companion*.

¹⁷ Woodbury, W. B. (12/05/1865) New Patent: Complete Specification of Patent Obtained by Walter Bently Woodbury, Manchester, filed 23rd March, 1865. *British Journal of Photography*. XII

lint and grease. The glass plate is initially cleaned and then and then polished with wax. The surface of the glass is then dusted with French chalk (powdered talcum) which is rubbed on and off with a soft rag^[18] or dusted off with a soft camelhair brush. These steps ensure a highly polished and clean surface for the support to be affixed to. The back of the plate is marked with a diamond scratch, easily distinguishing the front face from the back of the plate by touch in low visibility conditions as photosensitive gelatine may also be cast.

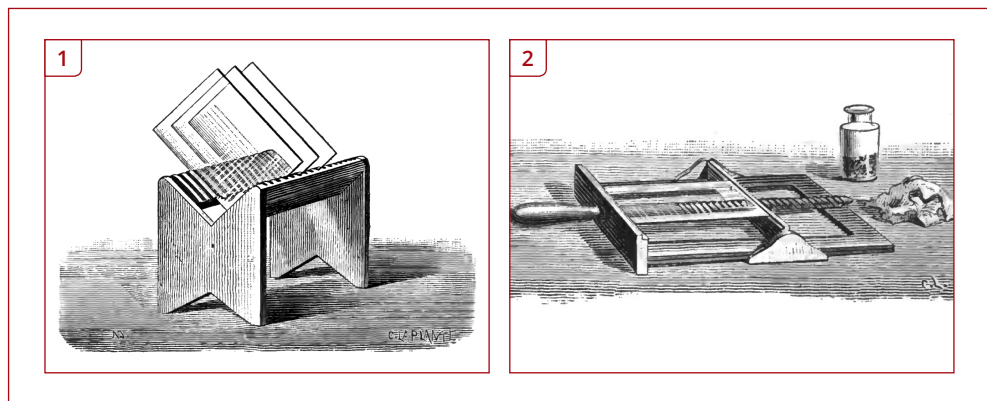

Figure 4.9 1) Glass plate drying rack 2) plate holder used for cleaning published in *A History and Handbook of Photography*, TISSANDIER, Gaston (1877)

If the desired size of image increases the level of skill needed also must increase. It is more cumbersome to clean large plates of glass and keep them free from fingerprints and dust. It is also more difficult to spread large gelatine tissues and have them dry evenly. Plate holders could be used to help with the initial cleaning.

Glass needs to have the cut edges ground to reduce the risk of injury handling it. This is something that a glazer can do when the glass is being purchased. If you opt to do it yourself then you have an increased risk of being injured by ground glass dust, glass splinters and shards. There is also higher risk of injury in handling it. The glass must be thoroughly cleaned to remove any production contamination from glass dust after the rounding of the edges. Domestic dishwashers enable cleaning of the glass to a high standard. They reduce the need for manual handling during the process and reduce the risk of lint and dust contamination as they dry.

As the gelatine mix needs to be spread oversize to allow for shrinkage and the trimming back, a larger sheet of glass is required than the final tissue size. 2mm framing glass

¹⁸ Unknown (13/04/1893) Extract - Messrs. Waterlow & Sons' Photo-Mechanical Printing Works. *British & Colonial Printer & Stationer*. XXXI

and 10mm toughened plate glass was used in this study. The glass was considerably heavier than plastic alternatives. Glass is always a concern as it can shatter.

4.6.4 Talc (Optional)

A sheet of flat level talc is cut slightly larger than the size needed for the gelatine tissue ^[19]. The talc is attached to the glass plate by putting a few drops of water onto the glass plate and placing the talc in contact with the plate with firm and even pressure.

4.6.5 Mica (Optional)

Mica can be used as a substitute for collodion on larger images ^[20]. Descriptions of mica mention that it was a more flexible material than glass when producing large tissues. Descriptions of the material was similar to that of flexible plastics.

4.6.6 Paper (Optional)

The glass plate is placed into a bath of warm water. A sheet of smooth paper slightly smaller than the glass plate is placed into the water and positioned against the face of the glass. The glass and paper are removed together from the water bath. Trapped air bubbles and excess water are then forced out with firm pressure being applied with a squeegee. This method is the same as Swans double transfer method for carbon printing. (No collodion support is used in later stages.

4.6.7 Alternative spreading supports

A series of modern plastics were tested as casting supports. They were found to be extremely durable and lightweight. The plastics were more prone to scratching than glass. This can be an issue with cleaning or stripping the tissue from the support. The risk of personal injury was greatly reduced as they were shatter proof.

4.6.8 Acrylic and Polycarbonate

10mm, 5mm, 3mm, 2mm, and 1mm acrylic and polycarbonate material was tested. To ensure smooth polished edges substrates were laser cut. CNC milling also produced good edges although not as highly polished as the laser without the use of specialist cutting tools or flame polishing.

4.6.9 Paper, paper substitutes and other flexible face substrates.

Flexible face substrates proved on the whole to work well with the exception of untreated paper. Synthetic plastic paper substitutes were lightweight, and extremely portable once the tissue had been cast. They do need to be clamped or fixed to a flat

19 Woodbury, W. B. (12/05/1865) New Patent: Complete Specification of Patent Obtained by Walter Bently Woodbury, Manchester, filed 23rd March, 1865. British Journal of Photography. XII

20 WOODBURY, W.B., 1869. Description of the Woodburytype, or Photo-Relief Process. The Photographic Journal, 14(Mar 16), pp. 4

surface when drying as they will distort due to the gelatine shrinking as it dries. If care is taken these synthetic materials can be reused several times. Medical imaging film was the most durable.

4.6.10 Paper

Paper contains fibres that the tissue mix can bond to. Paper is also fragile and very likely to tear when removing the tissue if a heavy weight is not used.

4.6.11 Acetate

Acetate proved to be a good material. It is very durable, clear and waterproof. The tissue had a very strong bond with it due to the high surface energy or dyne of the substrate. This substrate was capable of having multiple purposes and reducing the number of steps in the spreading and developing stages. It enabled exposure through the back of the tissue, removing the washing support stage altogether. If the dry tissue is stripped off the acetate it will tear the acetate. Exposed tissue will remain attached to the acetate during the developing stage. After development and tanning it will simply lift off when completely dry with no damage to the matrix. If a fold or crease is created in the acetate it becomes unsuitable for use as a spreading support.

4.6.12 Synthetic Paper

A commercially bought synthetic paper from the Yuppo brand was used. There are several weights available. Yuppo and medical imaging film perform well when producing tissues.

4.6.13 Medical Imaging Film

Unexposed AGFA medical imaging film was used. This gives extremely good results especially in producing the tissues for carbon tissues. It has a heavier weight than yuppo and can be reused.

4.6.14 Opaque materials

Opaque materials such as Yuppo paper will work but need to be exposed and mated (transferred) in the same manner as the double transfer carbon process or adhered to an additional support. If it is not transferred, the relief will release from the casting support due to the attached gelatine being washed out in the developing stages. This is due to the gelatine tissue being exposed to the negative on the face that is not attached to the support. This proved difficult to do.

This study primarily used acetate and rigid plastic supports.

4.6.15 Release agents (optional)

The glass plate is greased ^[21] before pouring on the support or gelatine. This facilitates easy tissue separation from the glass plate support.

The dyne value or surface energy of the support material will affect how easily the tissue can be removed from the support. Three release agents were tested in the tissue spreading: Renaissance wax, mould release wax and a microcline spray wax. The spray wax was the easiest to apply in a very thin layer, yet it was noticed that no added benefit in using the release agent was gained. When the tissue was spread on rigid plastic or glass it was removed very easily from the backing support once it had dried completely. The thicker the tissue the easier it is to remove. All that is required to remove it is to simply lift one of the tissues corners and peel it back. Plasticisers (See 4.6.30) in the tissue mix provide an advantage as they make the tissue less brittle and easier to remove. The tissue dries from the edges and towards the centre. If the tissue has not dried sufficiently it will stick, stretch and tear in the areas that still contain moisture.

4.6.16 Ox gall

The glass can also be rubbed or submerged in ox gall and left to dry prior to the tissue being spread. Explained by Swan on his process, Ox gall is used in the absence of a collodion layer and allows for the separation of the tissue from the glass (Wilson, 1868) ^[22]. Ox Gall was not tested or used as it was determined to be a moot issue due to the lack of mention in Woodburytype instructions.

4.6.17 Transparent base support

In most cases before spreading the tissue a transparent base layer had to be generated. There were various methods to create the support depending on preference. Unlike carbon printing where the relief is mated and released from the support directly onto the final substrate, Woodburytypes are unable to produce areas of burned-out highlights of white due to the relief being removed from the wash support and used independently of a substrate. Highlights within the print matrix contain little or no physical structure. This is a physical limitation that must be removed or reduced with the addition of a transparent base support. A base support is prepared usually on the spreading support before the tissue mix is spread. Without this base support, the exposure stage cannot proceed as it facilitates the stripping of the gelatine from the casting support ^[23]. There are two options for a base support, pouring collodion or using sensitized gelatine.

21 Sutton, T. (01/03/1870) A Week at the Woodbury - Printing Establishment of MM. Goupil at Anstieres, near Paris. The Photographic Art Journal.

22 Wilson, E.L. (1868) The American Carbon Manual. Scovill Manufacturing Company.

23 Unknown (13/04/1893) Extract - Messrs. Waterlow & Sons' Photo-Mechanical Printing Works. British & Colonial Printer & Stationer. XXXI

4.6.18 Collodion coating

Collodion was a common base support structure for the Woodburytype and was used in other 19th century photographic practices. The main ingredient of collodion is cellulose nitrate; referred to as pyroxyline, and commonly known as gun cotton. It was a common propellant in arms manufacture and as such is today a controlled substance. Cellulose nitrate is synthesised by dissolving cotton in sulphuric acid, drying it and then dissolving it again in nitric acid. While fumes are an immediate inhalation risk it is also a volatile and explosive substance. Its manufacture was the cause of many accidental explosions and accidental deaths (Photographic Journal, 1864) ^[24]. Due to risk involved in making cellulose nitrate it was advised to buy premade (Woodbury W.E. 1896) ^[25]. A cellulose acetate and acetone mixture can be used to make an alternative collodion. (Atkinson, 2005) ^[26] While pre-mixed collodion can be purchased from specialist photographic suppliers, adding the base support at a later stage was also a practical historical method.

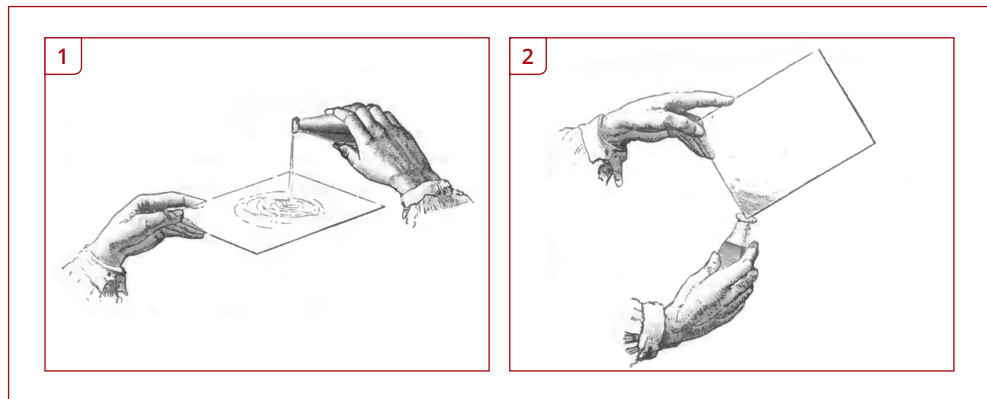

Figure 4.10 Illustration demonstrating the flowing of collodion on to the glass plate published in *A History and Handbook of Photography*, TISSANDIER, Gaston (1877)

4.6.19 Flowing the collodion

Collodion is flowed from a bottle onto and then off the glass support plate. The glass plate is held by one of the bottom corners and the collodion poured onto the plate either in the centre where it is flowed to the outer edges by rocking the glass. Another method is to pour the collodion onto the opposite corner from where it is being held and the glass plate is rocked again flowing the collodion from corner to corner. The excess collodion is then poured off the plate and collected back in its bottle. The plate is then left to dry.

²⁴ UNKNOWN, 1864. Explosion of Gun-Cotton. *The Photographic Journal*, (July 15), pp. 82

²⁵ Woodbury, W.E. (1896) *The Encyclopaedic Dictionary of Photography*. The Scovill & Adams Company of New York.

²⁶ Atkinson, A. (2005) *The Creation of Digital Photographic Fine Art Print through the Woodburytype Model*. University of the West of England.

MM Goupil et Cie, added the collodion support after the tissue had been produced and dried (Sutton, 1870).^[27] Flowing the collodion onto large glass plates also requires more skill to flow the collodion smoothly and evenly without contamination.

4.6.20 Variation of base structure - sensitized gelatine and skinning

Photosensitized gelatine can be used to generate a supportive base structure. There are two methods of doing this. The first method involves spreading some of the sensitized tissue mix onto the glass casting support. Once it dries, expose it to UV light which causes the gelatine to react and cross-link.

The second method involves placing a prepared photosensitized tissue into an empty exposure frame (or unit) and briefly exposing it to form a “skin”. This is done prior to the spreading of the gelatine for the tissue. Both of these methods can increase the thickness of the base support. The method preferred in this research was the skinning method.

4.6.21 No support material or support added at a later stage

The gelatine tissue can be cast without the need for a base support however nearly all references of the process mention an additional support base as the tissue is adhered to a washing support. The development stage can only proceed if there is a suitable base structure on the relief. If no support is added it is stated that collodion can be poured onto the tissue at a later stage^[28] as per MM Goupil et Cie. Alternatively the sensitized tissue can be given a very short exposure by placing it in an empty exposing frame and briefly exposing it to form a “skin” prior to the main exposure. I used a variation on the “skinning” process. I exposed my negative for just a slightly longer time than what was required to produce the latent image. In doing so it allowed a base support to form without the need of setting up the gelatine in the exposure unit twice. I did test the method where the tissue was flash exposed in a UV exposure unit very briefly without a negative. While this worked it didn’t offer any discernible difference to the method I opted for. Thicker base supports affect the depressions in the printing plate and the ink strengths later on.

4.6.22 Gelatine tissue mix

A gelatine tissue is made, similar to that used in carbon tissue formulæ. The gelatine tissue can be made to initially include a photosensitive chemical or it can be made photosensitive at a later stage. I preferred to make my tissue photosensitive at a later stage before use.

²⁷ Sutton, T. (01/03/1870) A Week at the Woodbury - Printing Establishment of MM. Goupil at Ansieres, near Paris. The Photographic Art Journal.

²⁸ Sutton, T. (01/03/1870) A Week at the Woodbury - Printing Establishment of MM. Goupil at Ansieres, near Paris. The Photographic Art Journal.

4.6.23 Units of Measurement

It was observed in the literature survey that there was a vast mix of units of weights and measures used within the recipes. Proportional volume and metric were the easiest to understand. The difficulty in following the tables arises with the imperial measurements. There was more than one type of imperial measurement in operation in the mid 19th century. This makes following the recipes not as straightforward as one would expect. Woodbury's son, a photographer and author on the subject states

"The confusion surrounding the English system of measurement is without doubt very great. All solid chemicals are sold by avoirdupois weight, while most formulæ are written in apothecaries' weight..." (Woodbury, 1898) ^[29]

The problem was still unresolved 14 years later (1912) despite many acts and statutes being passed to try and standardise measurements (UK Medical Act of 1858) which required the use of avoirdupois weight.^[30] By the mid 1800's America had only started to adopt the units based on the British "Weights and Measures Act of 1824"^[31] (Encyclopædia Britannica)^[32]. The British continued to reform their systems through additional statutes (Weights and Measures Act of 1878)^[33] abolishing the troy pound and leaving only the apothecaries' ounce^[34] from the old system in use. (Appendix 4)

4.6.24 Recipes matrix

Final decisions on the formulæ is ultimately down to user preference, as EJ Wall writes, the following about weights and measures:

"In ordinary photographic operations extreme accuracy in weighing and measuring is not required" (Wall, 1912)^[35] he continues to highlight the same problem in 1912 by stating... *"There appears to be no settled convention as to whether the ounce avoirdupois or the ounce apothecary should be used in formulae ..."* (Wall, 1912)^[36] he continues... *"Some form of definite settlement as to the correct ounce to use in formulae is badly needed."* (Wall, 1912)^[37]

29 WOODBURY, W.E., 01/01/1898. Stanotype. Scovill & Adams.

30 An Act to regulate the Qualifications of Practitioners in Medicine and Surgery. Great Britain 2 August 1858 Retrieved 16 September 2016. http://www.legislation.gov.uk/ukpga/1858/90/pdfs/ukpga_18580090_en.pdf

31 http://www.legislation.gov.uk/ukpga/1824/74/pdfs/ukpga_18240074_en.pdf

32 <https://www.britannica.com/science/British-Imperial-System#ref23101>

33 Weights and Measures Act of 1878 or 41 & 42 Vict. c. 49[79] Great Britain (1878). Statutes at large. pp. 308–341. Retrieved 16 September 2016.

34 Great Britain (1878). Statutes at large. pp. 308–341

35 Wall, E.J. (1912) The Dictionary of Photography and Reference Book for Amateur and Professional Photographers. 9th ed. London: Hazell, Watson & Viney, Ltd.

36 Ibid

37 Ibid

Therefore as it was uncertain during this study whether the unit of measure in the Victorian recipes were Apothecaries' weight, Avoirdupois weight, US Imperial, European Imperial or Troy. The units have been listed as they were initially recorded. The collection of recipes can be seen in Appendix 4.

4.6.25 Additive ingredients

In addition to the basic gelatine mix used for making tissues, additive ingredients can be mixed in which will reduce or exaggerate a property of the gelatine tissue. The properties affected include increasing the lifespan by reducing the chance of fungal growth, reducing gas and bubbles forming by lowering the surface tension of the mix or increased flexibility by reducing brittleness when dry.

4.6.26 Storage of Tissue mix

Gelatine is a natural substance made from the rendered skin and cartilage of animal remains. As such it can spoil like food as bacteria grows on it. Modern manufacturing methods enable gelatine to be produced in a more controlled and consistent method. Tissue mix can be made in advance and stored in a refrigerator or by freezing it into jelly cubes using an ice-cube tray. The cubes can be made to a higher concentration and the additional water added to it later. Where when needed the remainder of warm water could be added or simply re-melted when defrosted over a double boiler.

4.6.27 Biocides

Phenols dissolved in an alcohol solution can be added to reduce the growth of fungus in gelatine (British and Colonial Printer and Stationer, 1893)^[38]. Gelatine that is drying without the use of a drying aid is at risk of spoiling as it may be stored partially dried. The use of biocides such as phenols can extend the shelf life of refrigerated gelatine prior to spreading, and also prevent mould developing on drying tissues. Thymol can also be used, it is readily available and is a common fungicide in beekeeping. Through the empirical investigation drying methods were being observed with and without samples containing a biocide. It was observed that if the drying time was longer than a day and the gelatine did not contain biocides the mould would grow rapidly at room temperature. Formaldehyde HCHO (Nadeau, 1986)^[39] can be added as an alternative biocide. It is toxic and a suspected carcinogen.

4.6.28 Surface tension

Alcohol can be added to the gelatine mix. Alcohol has a lower surface tension than water. When added to the tissue mix it will lower the surface tension of the gelatine

38 Unknown (13/04/1893) Extract - Messrs. Waterlow & Sons' Photo-Mechanical Printing Works. British & Colonial Printer & Stationer. XXXI

39 Nadeau, L. (1986) Modern Carbon Printing: A Practical Guide to the Ultimate in Permanent Photographic Printing: Monochrome Carbon Transfer and Carbro [online]. Fredericton, New Brunswick: Atelier Luis Nadeau.

tissue mix and help reduce bubbles forming. Too much alcohol prevents the gelatine from setting. See purified water for more advice on bubbles.

4.6.29 Purified water

The water that is mixed with the gelatine has an impact on the quality of the tissue. Warm water tap will contain naturally trapped gasses. It can be used, but it must be treated before use by triple boiling, ie repeatedly boiling and cooling which will remove trapped gases in the liquid. Bubbles are difficult and time consuming to remove from gelatine. Using unprepared tap water can spoil tissues (Figure 4.11) If water purity is a concern, de-ionised or purified water can be used. Do not use water or temperatures in excess of 45°C to melt or dissolve the gelatine. Use a water bath or double boilers to heat water and maintain at the correct temperature. Do not mix the solution with unprepared water.

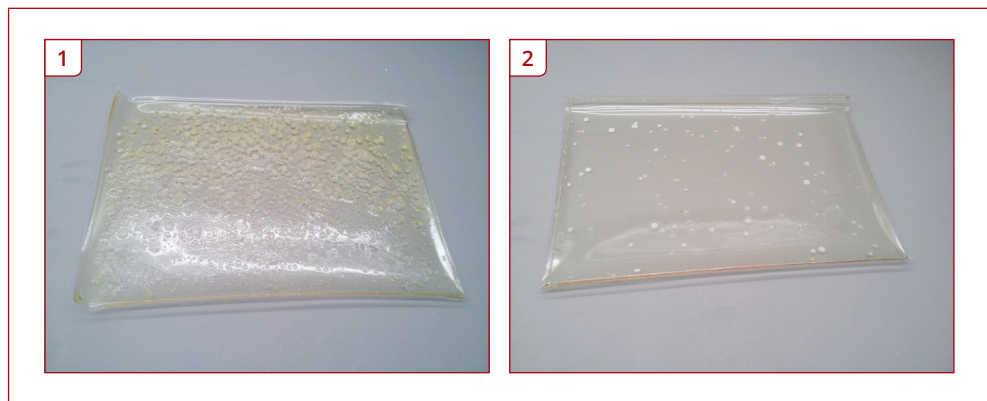

Figure 4.11 1) Bubbles caused by using non-distilled hot tap water. 2) Fungal growth caused by slow drying time without the use of biocides.

4.6.30 Plasticisers

Sugar and / or glycerol are mixed with the gelatine to increase the flexibility of the tissue (Woodbury, 1865)^[40]. Glycerol is optional and is mostly added in areas of high arid humidity but can also create a fog on the tissue. It was observed that tissue with added plasticiser was easier to cut to size and less likely to shatter or crack when dry. Tissue that will be stored for a longer period of time will remain more pliable if glycerol is added making it less brittle.

4.6.31 SOAP

In carbon printing soap was added to the tissue mix in place of glycerine. Some of the recipes that include soap are listed in Appendix 4.

⁴⁰ Woodbury, W.B. (12/05/1865) New Patent: Complete Specification of Patent Obtained by Walter Bently Woodbury, Manchester, filed 23rd March, 1865. British Journal of Photography. XII

4.6.32 Bloom value and quality of gelatine

A bloom factor of 220blm or higher was ascertained as a benchmark. Various gelatines were used and in some recipes a combination of gelatines were used. Skin gelatine was noted as being optically clearer than bone gelatine. Fish Glue (a fish derived gelatine) was in some recipes added. The production procedures of gelatine now is considerably higher and more controlled than in 1865 where instructions were to reject gelatines that have 4% of ash (Ott, 1880)^[41]. Photographic grade gelatine can be purchased but is expensive. Gelatines that can hold between 5 – 7 times their weight are best for the Woodburytype, the higher the number the better (Ott,1880).^[42] The more water a gelatine can absorb the better the adhesive power (Ott,1880).^[43] This study used 240blm food grade pig skin gelatine with good results throughout.

4.6.33 Gelatine strength and initial thickness of tissue

The volume of the gelatine used in the tissue mix has a direct relation to the thickness of the dried tissue. The gelatine was described as having the consistency of syrup (The Lithographer, 1874)^[44]. Not all reports included recipes and describing only the viscosity or thickness of the gelatine. This can cause confusion as the viscosity can be controlled through the concentration and / or temperature of the gelatine while in a liquid state. The concentration can also control the thickness of the dried tissue.

Tissue with a high percentage of gelatine dries to a greater thickness than tissues which contain a lower percentage of gelatine. Tissue mix with a high percentage of gelatine will have a higher melting point. In the developing and washing stages (4.15) of the process a high gelatine concentration in the tissue increases the soaking time, development time and temperature of the water needed for the washing out.

In warm weather, higher percentages of gelatine were required so the tissue could set (Woodbury, 1865)^[45]. Woodburytype printing was problematic in Australia (Royal Photographic Society, 2008)^[46], as high humidity and hot summer temperatures prevented the gelatine needed for tissue manufacture and printing from setting. Furthermore as temperatures and conditions varied across North America, the

41 Ott, A. (25/06/1880) Examination and Selection of Gelatine for Photo-Mechanical Printing. Photographic News. XXIV

42 Ott, A. (25/06/1880) Examination and Selection of Gelatine for Photo-Mechanical Printing. Photographic News. XXIV

43 Ott, A. (25/06/1880) Examination and Selection of Gelatine for Photo-Mechanical Printing. Photographic News. XXIV

44 Unknown (15/01/1874) The Correlation of Photography, Lithography, and Typography: The Woodburytype Process. The Lithographer.

45 Woodbury, W.B. (15/12/1865) A New Photo-Relief Printing Process. The Photographic Journal.

46 The Royal Photographic Society, Victorian Chapter (2008) Walter Woodbury. A Victorian Study. 1st ed. Melbourne, Australia: RPS Victorian Chapter.

environmental conditions prevented a standard formula being developed there. The Woodburytype was perfected in England but proven a failure in America (Photographic News 1879)^[47] and never worked with a great degree of success in America (Burton, 1887)^[48]. By 1887 it was obsolete in the US (Burton, 1887)^[49].

Tissue thicknesses ranged from 1/8 inch (3.175mm) (Swan, 1865)^[50] (Woodbury, 1865)^[51], 1/16inch (1.5mm) (Woodbury, 1865)^[52]. 5oz of gelatine will make a tissue 1sq foot in size (British Colonial Printer & Stationer, 1893)^[53]

Some initial tests were done regarding the thickness of the tissue. Carbon manuals state that pronounced carbon prints can be produced by using a thicker tissue but that it took longer to dry and was more susceptible to distorting as it dried. Carbon tissues in general are spread on a flexible face support. Woodburytypes were typically spread on a glass support which prevented the tissue distorting.

4.6.34 Pigmented tissue

A weak pigment can be added with India ink for example to the gelatine tissue when it is being made (The Photographic Journal, 1865)^[54]. The purpose of the pigment is to aid in the viewing of a latent image during the exposure stage and washing out or developing stage. In carbon printing when ink is added to the gelatine to be made into tissue it is called 'glop'. Pigmented tissue produces a lower relief in comparison to non pigmented tissue (British & Colonial Printer & Stationer, 1893)^[55], this was noted too through the practical tests of this study. Through empirical tests un-pigmented tissues sensitized with potassium dichromate produced a very visible latent without the addition of pigment. (See Figure 4.26) Indian ink specified by Burton, appears black is a very dark blue. This makes it invisible to UV light and suitable for the tissue, although other blacks may not have the same UV properties. India ink can also be used to prevent the UV light penetrating too far allowing the tissue to be released from a paper backing in the

47 Unknown (09/05/1879) Photo-Collographic Printing - The Artotype Process. Photographic News. XXIII

48 Burton, P.W.B. (24/06/1887) E. Edward's Photo-Mechanical Works, Brooklyn, New York. Photographic News. XXXI

49 Ibid

50 Swan, J. (05/05/1865) Mr. Swan's Claim Versus Mr. Woodbury's. British Journal of Photography. XII

51 Woodbury, W.B. (12/05/1865) New Patent: Complete Specification of Patent Obtained by Walter Bently Woodbury, Manchester, filed 23rd March, 1865. British Journal of Photography. XII

52 Ibid

53 Unknown (13/04/1893) Extract - Messrs. Waterlow & Sons' Photo-Mechanical Printing Works. British & Colonial Printer & Stationer. XXXI

54 Unknown (15/12/1865) Mr. Woodbury's Photo-Relievo Process. The Photographic Journal.

55 Unknown (13/04/1893) Extract - Messrs. Waterlow & Sons' Photo-Mechanical Printing Works. British & Colonial Printer & Stationer. XXXI

washing out stage. It was also said to preventing lateral spreading of UV light that may cause a loss of crispness in the image (British Journal of Photography, 1880).^[56]

4.6.35 Photosensitising chemicals

Traditionally two photosensitizers were employed. Potassium dichromate $K_2Cr_2O_7$ or ammonia dichromate $(NH_4)_2Cr_2O_7$. Either can be used in solution form as the photosensitising agent. Colloids such as gelatine when in the presence of these dichromates and exposed to strong UV light will harden the cells making them insoluble.^[57] Not all accounts specify which dichromate is being used. Some name them specifically while others simply call them "bichromate". The concentration of sensitizer affects sensitivity (or speed) and the contrast. (Nadeau, Modern Carbon Printing, 1886)^[58]

4.6.36 Dichromate stability

Ammonia dichromate is inflammable, thermodynamically unstable, and will explode if heated. Potassium dichromate is more stable in this regard. For the empirical investigation within this research project potassium dichromate was used as the tissue photosensitizer. Potassium dichromate is the sensitizer that is now further referenced unless specifically stated otherwise.

4.6.37 Dichromate toxicity.

The toxicity of chromium in the body varies with its oxidation state. Trivalent chromium or chromium III (Cr III) is less toxic than hexavalent chromium or chromium VI (Cr VI). The chemicals used for photosensitising tissue in the Woodburytype and Carbon Process are classed as hexavalent chromiums and as such are highly dangerous if mishandled. Hexavalent chromium is a potent sensitizer of the skin, highly toxic and carcinogenic.^[59] Trivalent chromium is generally benign and even a known micronutrient in an organic form.^[60]

56 Unknown (28/05/1880) Mr. Woodbury's New Process: Hints on Making Reliefs. British Journal of Photography. XXVII

57 KOSAR, J., 1965. Light-Sensitive Systems: Chemistry and Application of Nonsilver Halide Photographic Processes. New York: John Wiley & Sons.

58 Nadeau, L. (1986) Modern Carbon Printing: A Practical Guide to the Ultimate in Permanent Photographic Printing: Monochrome Carbon Transfer and Carbro [online]. Fredericton, New Brunswick: Atelier Luis Nadeau.

59 SAHA, R., NANDI, R. and SAHA, B., 2011. Sources and toxicity of hexavalent chromium. Journal of Coordination Chemistry, Vol 64, No 10(20 May 2011), pp. 1782-1806

60 KIMBROUGH, D.E., COHEN, Y., WINER, A.M., CREELMAN, L. and MABUNI, C., 1999. A Critical Assessment of Chromium in the Environment. Critical Reviews in Environmental Science and Technology, 29(1), pp. 1-46

The causation of disease attributed to dichromates in the 19th century was known. There are cases reported in The American Carbon Manual ^[61] on the various ways one could be poisoned accidentally and injured through ingestion, contact and inhalation. One case mentioned in the manual is a practical joke played by a factory worker on his co-workers. The joker put some dichromate into his colleagues' cider hoping to give them diarrhoea after they drank it. Quite often the chemicals are only as dangerous as the person handling them.

4.6.38 Environmental concern

As mentioned hexavalent chromium is highly toxic to the environment, and many plants and animals. Waste dichromates used in the process must be disposed of carefully and correctly. All dichromate used in this study was disposed off in a responsible manner through the use of a specialist chemical waste company.

4.6.39 21st century environmental cases

In recent times cases of industrial negligence in the disposal of waste chromium become more apparent to the public. The people directly affected are able to take legal action against the companies responsible and this quite often makes news headlines. A case that took place in 1995 "Anderson et al v. Pacific Gas & Electric (PG&E)" was a landmark in American legal history where a plaintiff of 634 people who had all been poisoned by a CrVI took legal action against PG&E and were awarded \$333 million.

4.6.40 Reducing toxicity and disposal of potassium dichromate

Solution strength of the dichromate effects the colour (Kitson, Mellon, 1944)^[62]. Sodium thiosulphate is commonly referred to in photography as "hypo" and in other chemical processes Sodium thiosulphate $\text{Na}_2\text{S}_2\text{O}_3$ is often standardized with potassium dichromate.^[63] Conversely mixing Potassium dichromate with sodium thiosulphate reduces the hexavalent chromium making it a trivalent chromium. Once the chemical reaction between hypo and potassium dichromate occurs it is safer to handle and dispose of. The reaction can be seen visually where the potassium dichromate changes colour from a vivid orange to a green / brown colour.

61 WILSON, E.L., 1868. The American Carbon Manual. Scovill Manufacturing Company.

62 KITSON, R.E. and MELLON, M.G. (1944) Color of Aqueous Potassium Dichromate Solutions. Industrial and Engineering Chemistry. 16 (1), pp.42-44.

63 ASAKAI, T. and HIOKI, A., 2015. Reliability in standardization of sodium thiosulfate with potassium dichromate. Microchemical Journal, 123(November), pp. 9-14

4.6.41 Non-carcinogenic variation

Contemporary trials used ammonia citric ferric as a sensitizer for carbon printing, it was hypothesised in the original study that it would be suitable too for Woodburytype printing, although it was not tested. (Bjørngård, 2007)^[64] This method was tested and will be discussed later as part of the empirical study. (See Appendix4)

4.6.42 Increase in photosensitivity

The toxicity of potassium dichromate reduces through oxidation. A change in colour can be noticed as it changes oxidises from a bright orange (CrVI) to a green / brown (CrIII).

4.6.43 Dark effect and continuing effect

The sensitivity (or speed) of unexposed tissues increases over time at room temperature. This is called the dark effect. When sensitized tissue is exposed but not developed, it too will also gain speed. This is called the continuing effect and is most noticeable in the first hour after exposure. (Nadeau, Modern Carbon Printing, 1886)^[65] It is best to use regularly replenish the chemicals and develop images within the first hour of exposure.

4.6.44 Making the photosensitive tissue

Several methods can be used to make photosensitive tissue. There are positive and negative aspects to each method and ultimately the chosen method is the preference of the printer.

4.6.45 Pre-sensitized gelatine tissue mix

The gelatine while in a liquid state has sensitizer in solution added (Woodbury, 1865)^[66]. When thoroughly mixed the tissue is spread (Figure 4.14). The advantages with this method is that the exact amount of sensitizer can be used minimising waste and waste disposal. Ammonia Dichromate solution can be mixed to a concentrated state of 3:1 its normal sensitizer strength, and then diluted with 2 parts of alcohol to 1 part dichromate solution so that the final volume of sensitizer is at the normal sensitizer strength per volume. (Nadeau, Modern Carbon Printing, 1886)^[67] Potassium

⁶⁴ Bjørngård, H. (2007) The Chiba System : A Non Toxic Alternative to the Dichromate Processes. Or the Product Ion of Photographic Prints in Permanent Pigments by Utilising the Sensitivity of the Ferric Salt to the Spectre and Employing the Polymer Izat Ion of Col Loids. Graduate School of Science and Technology, CHIBA UNIVERSITY.

⁶⁵ Nadeau, L. (1986) Modern Carbon Printing: A Practical Guide to the Ultimate in Permanent Photographic Printing: Monochrome Carbon Transfer and Carbro [online]. Fredericton, New Brunswick: Atelier Luis Nadeau.

⁶⁶ Woodbury, W.B. (17/03/1865) Woodbury's New Printing Process. British Journal of Photography. XII

⁶⁷ Nadeau, L. (1986) Modern Carbon Printing: A Practical Guide to the Ultimate in Permanent Photographic Printing: Monochrome Carbon Transfer and Carbro [online]. Fredericton, New Brunswick: Atelier Luis Nadeau.

dichromate is insoluble in alcohol and this method will cause dichromate crystals to precipitate on the surface of the tissue. (Nadeau, Modern Carbon Printing, 1886) ^[68]

4.6.46 Gelatine tissue sensitized by brushing on sensitizer.

Using this method allows pre cast and dried gelatine tissue to have the sensitizer brushed on to its surface. As the gelatine is dry it will absorb the sensitizer. Multiple gelatine tissues may be cast, dried and later sensitized when needed.

4.6.47 Gelatine tissue sensitized by bathing in sensitizer.

Multiple gelatine tissues can be cast in advanced, stored, and then sensitized and when needed with fresh sensitizer solution. This tissue once stripped off the support can be bathed in the sensitising solution and then left to dry flat (Bolas, 1878)^[69]. Sensitising multiple tissues in this manner over time lowers the concentration of the bath as dichromate ions are removed with every tissue sensitized. If the sensitizer is not replenished it can result in increased exposure times and higher contrast in the exposures. (Nadeau, 1886) ^[70]

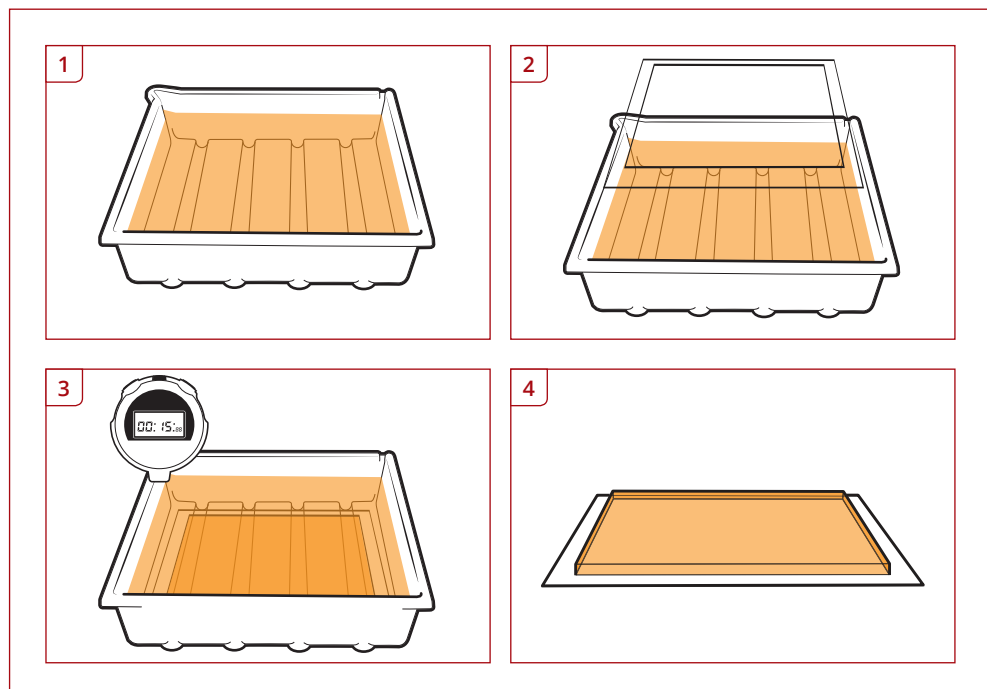

Figure 4.12 Bath sensitizer

⁶⁸ Nadeau, L. (1986) Modern Carbon Printing: A Practical Guide to the Ultimate in Permanent Photographic Printing: Monochrome Carbon Transfer and Carbro [online]. Fredericton, New Brunswick: Atelier Luis Nadeau.

⁶⁹ Bolas, T. (16/08/1878) Extract - The Application of Photography to the Production of Printing Surfaces and Pictures in Pigment. Photographic News. XXII

⁷⁰ Nadeau, L. (1986) Modern Carbon Printing: A Practical Guide to the Ultimate in Permanent Photographic Printing: Monochrome Carbon Transfer and Carbro [online]. Fredericton, New Brunswick: Atelier Luis Nadeau.

4.6.48 Tissue and sensitizer mix used in this study

Water: 1000ml

Gelatine:100g (240blm)

White sugar: 24g

Glycerine: 10ml

Thymol: 5ml in 15% IPA solution

IPA: 5-15ml

Sensitizer

Potassium Dichromate: 6% in bath solution

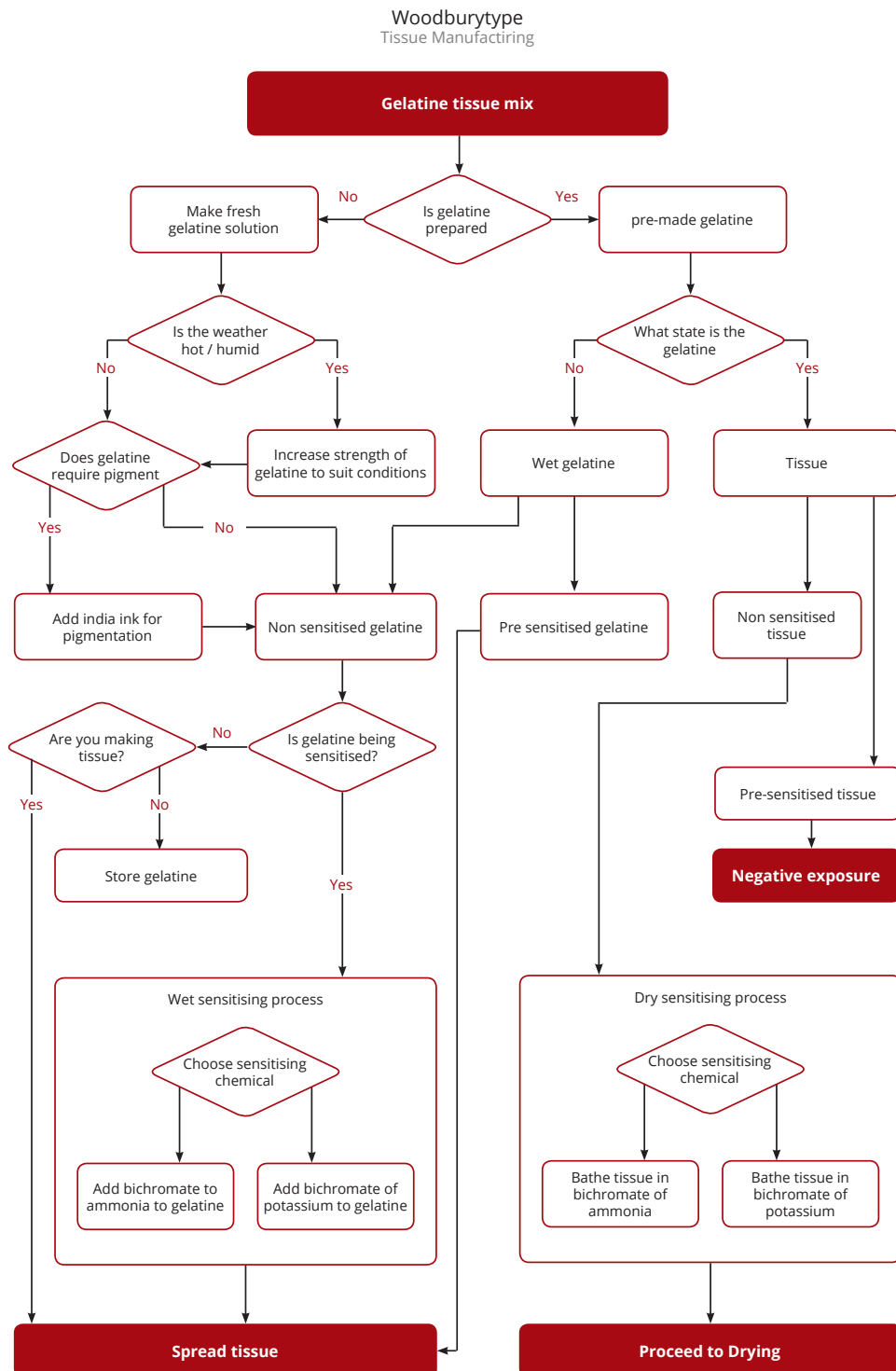

Figure 4.13 Tissue mix

4.6.49 Spreading the tissue

The tissue mixture is poured or cast in one of two states depending on preference (photosensitive or non-photosensitive), upon a casting support. Whatever preference is used this procedure is the same. The glass plates are gently warmed, (Photographic News, 1883)^[71] and placed on a levelling stand. (Woodbury, 1885)^[72] At this stage the warmed gelatine is spread upon the glass surface and allowed to take a level on the glass at a predetermined thickness. (Woodbury, 1885)^[73] The glass and tissue may then be transferred and placed level in a desiccating box, or left to dry undisturbed. (British Journal of Photography, 1865)^[74]

Later methods describe that a wooden frame is placed upon the glass support and the gelatine is poured into the aperture of the frame (Bolas, 1878).^[75] This is a mould allowing for consistent production of tissues at specific thicknesses when cooled, with a measured and controlled volume of tissue mix being used.

The best method that was used was to flow in the tissue mix off a sheet of glass to reduce bubbles. This method produced next to no splashes or bubbles, any that were produced could be removed by using a comb or a pipette. It was an extremely simple way of casting the tissue. Further descriptions are in Appendix 4.

⁷¹ Unknown (16/11/1883) The Woodbury Process: Second Article. Photographic News. XXVII

⁷² Woodbury, W.B. (18/08/1865) The New Photo-Relief Printing Process In Semi-Transparent Ink. Photographic News. IX

⁷³ Ibid

⁷⁴ Unknown (25/08/1865) Printing Photographs from Metal Plates. British Journal of Photography. XII

⁷⁵ Bolas, T. (16/08/1878) Extract - The Application of Photography to the Production of Printing Surfaces and Pictures in Pigment. Photographic News. XXII

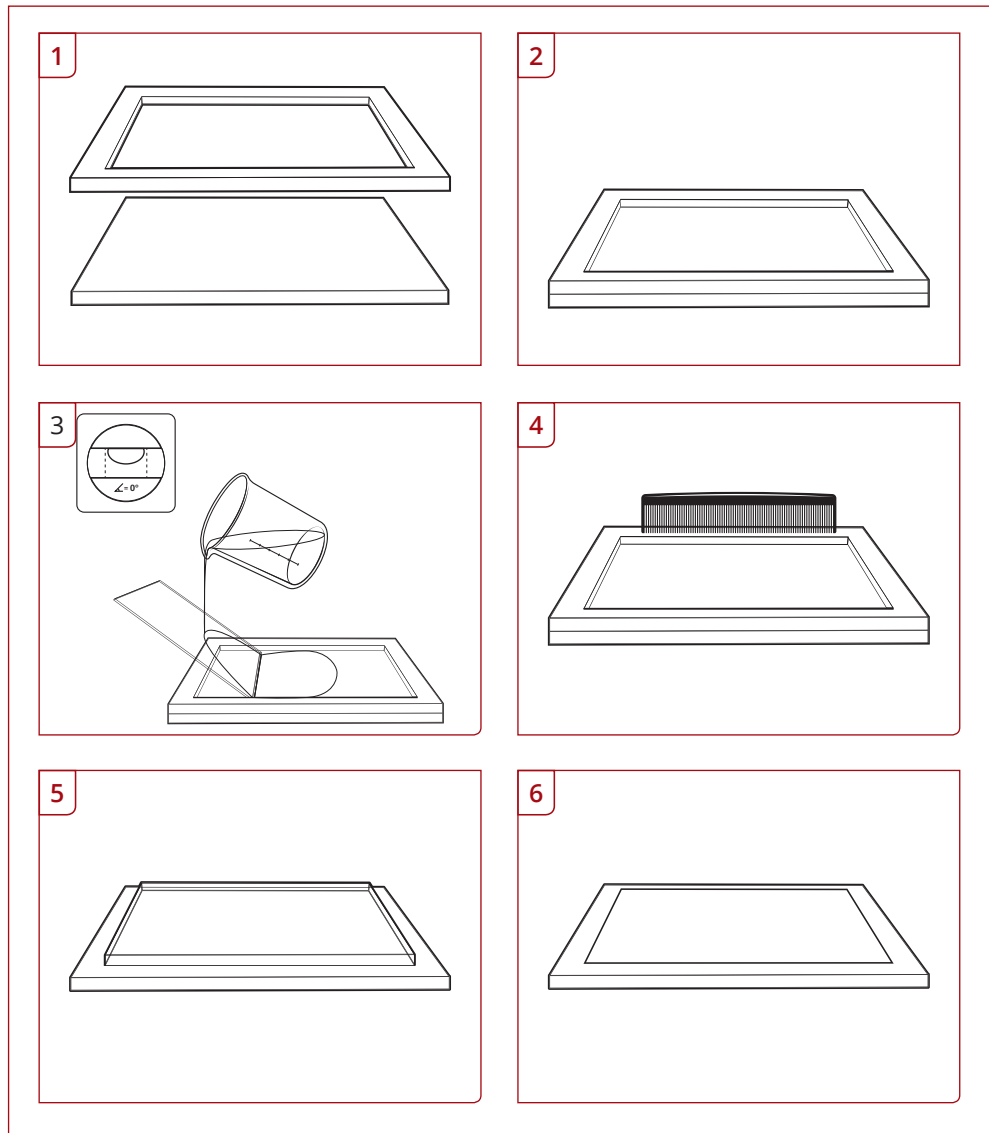

Figure 4.14 Spreading the gelatine

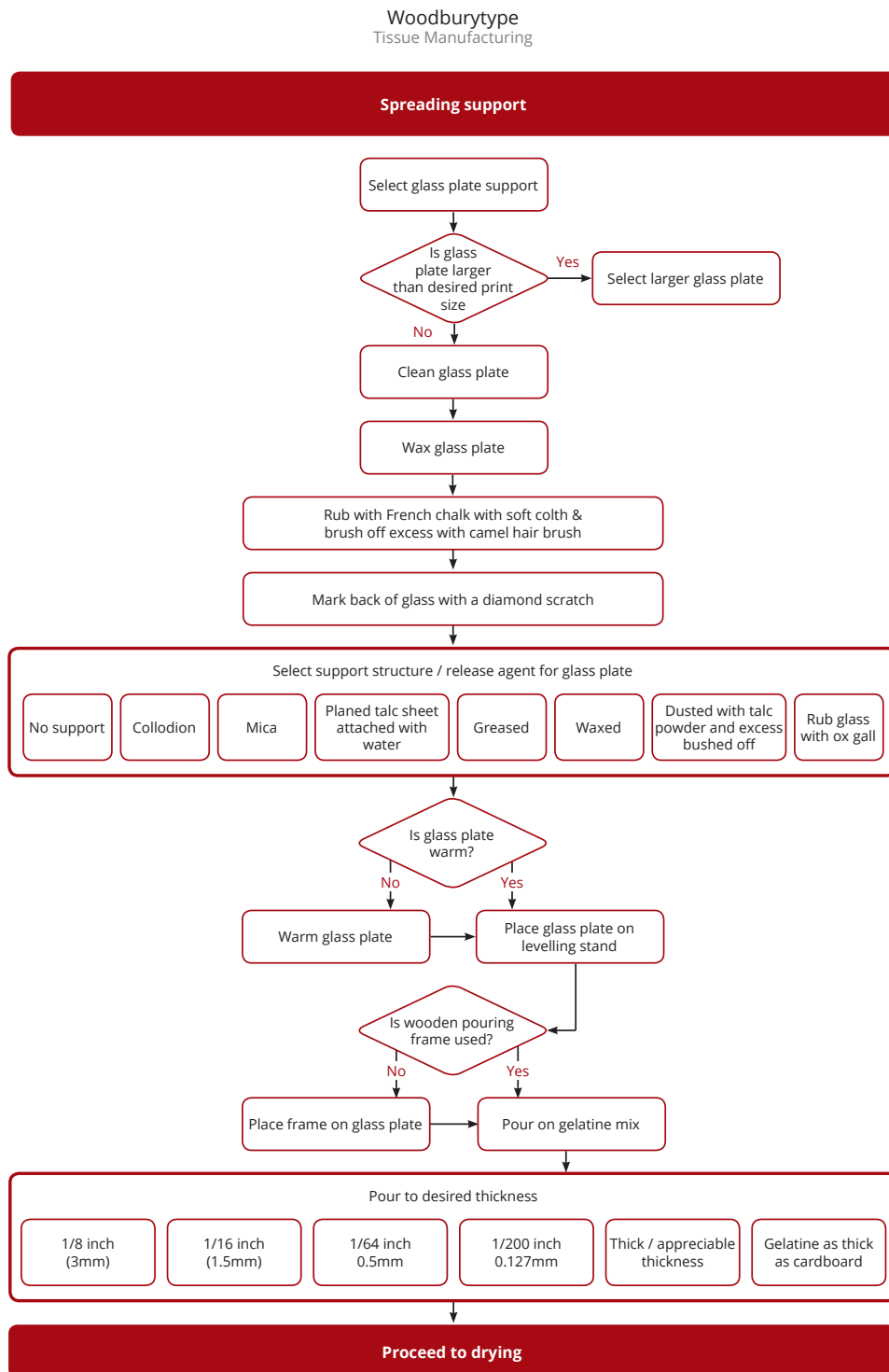

Figure 4.16 Spreading



Figure 4.15 Gelating tissue cast at 210mm x 297mm (A4) x 5mm thickness before the drying stage

4.6.50 Tissue thickness

A consistent description of the thickness of the wet cast tissue was not available. There are many different references that are available for tissue thickness and most refer to it in a dried state. Specific measurements state that the tissue should be cast to 1/8th inch (3.17mm) (Swan,1865) ^[76], 1/16th inch (1.59mm) or 1/200th (0.13mm) inch in thickness (Woodbury,1865) ^[77]. Other descriptions describe it 'as thick as cardboard', being spread to 'an appreciable thickness', or simply as 'pretty thick' (Waterlow, Geddes,1892). ^[78] It was observed that exposure times can also be affected by tissue thickness. The gelatine must be thick enough so that a latent image can be fully exposed into it. If the gelatine is cast too thick then it will take longer to develop the image in the wash-out stages as excess unexposed tissue must be dissolved away.

⁷⁶ Swan, J. (19/05/1865) Mr. Swan's Claim Versus Mr. Woodbury's. *British Journal of Photography*. XII

⁷⁷ Woodbury, W.B. (12/05/1865) New Patent: Complete Specification of Patent Obtained by Walter Bently Woodbury, Manchester, filed 23rd March, 1865. *British Journal of Photography*. XII

⁷⁸ Waterlow, P. and Geddes, J.D. (15/04/1892) Extract - *Photography and Photo-Mechanical Printing (Part 1)*. *Photographic News*. XXXVI

4.6.51 Cooling and drying times

As gelatine is an organic substance the tissue needs to be dried quickly to prevent spoiling (and fogging if sensitized). Cooling time depends on the surrounding environmental conditions. It takes longer to cool to a setting point in warm conditions. Conversely it will also take longer to dry in cold temperatures and damp conditions. Tissue with a low percentage of gelatine will have a higher percentage of water, also resulting in longer drying times. Drying in cool temperatures can take any time from 10 - 20 hours to a few days. This was consistent with descriptions.

Today, cooling and setting warm gelatine can be controlled with air-conditioning and refrigeration.

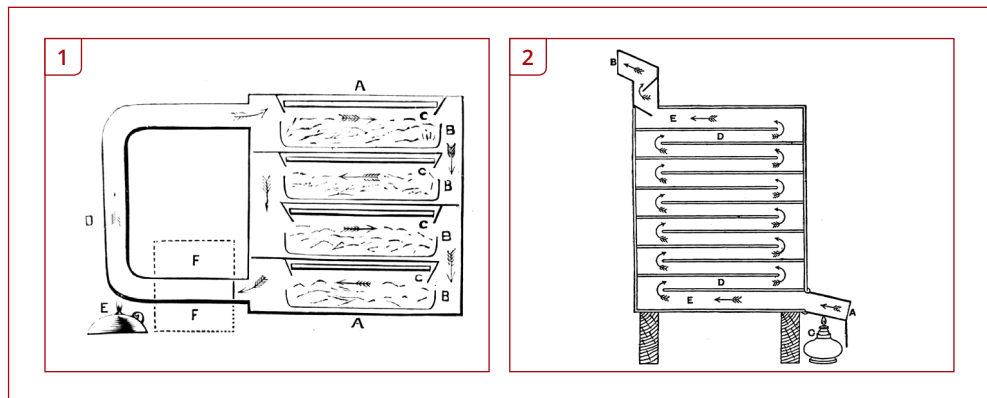

Figure 4.17 Drying cabinets 1) Published in Photographic News, September 14th 1883

Drying is expedited by placing the tissues into a desiccating / drying box (Woodbury, 1865).^[79] The desiccating box ideally needs to be lightfast or stored in a light-safe room.

Photographic drying cabinets allow for the vertical hanging of negatives. Cabinets used to dry Woodburytype tissues required horizontal racks. Vertical drying causes an even overall thickness due to the weight of the tissue being pulled by gravity. The gelatine will migrate downwards and cause the tissue to try in a tear drop shape and / or with an inconsistent thickness.

The tissue on the glass plate was described as being suspended face down above the desiccant, but not touching it. (Figure 4.17) The desiccating box flows warm air between 26°C - 30°C over a tray of Chloride of Calcium. In the use of a desiccating box the drying

⁷⁹ Woodbury, W. B. (12/05/1865) New Patent: Complete Specification of Patent Obtained by Walter Bently Woodbury, Manchester, filed 23rd March, 1865. British Journal of Photography. XII

times stated as between 5 – 8 hours (Woodbury, 1865)^[80]. The drying could take up to 2-3 days (Woodbury, 1865)^[81]. Drying times are in relation to the water content and thickness of the tissue. Drying times will be variable and dependent on the size of tissue and environment.

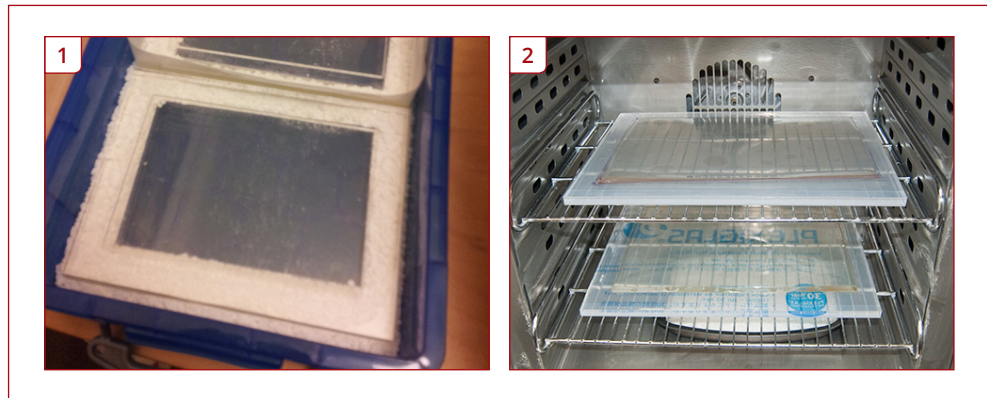

Figure 4.18 Dessicating tray and drying cabinet

Tissue may be dried to a state that is not perfectly desiccated and cut to size if preferred. The tissue is easier to cut in this state and less prone to cracking or shattering.

The dry state will be apparent to the observer. The tissue will feel completely dry, smooth, and will have reduced significantly in height. When tapped with a fingernail it will sound like tapping stiff plastic. Convex edges form on the tissue as it dries. These can be trimmed off before removing from the plate. The tissue is cut to size using a sharp blade, such as a utility knife or scalpel. It was found that trimming after removing from the support was more likely to damage the tissue and scuff the surface. The tissue can be trimmed to size and then stripped from the glass. When stripped from the rigid support it will come away in one clean motion.

The higher the concentration of gelatine within the tissue permits warmer drying conditions due to the melting point but there is an upper limit as the tissue will melt if it gets too warm. Temperature can be gently ramped up in increments as water is evaporated from the tissue over the duration of the drying process. The cast tissue needs to be larger than the photographic image that is being created.

80 Ibid

81 Woodbury, W.B. (18/08/1865) The New Photo-Relief Printing Process In Semi-Transparent Ink. Photographic News. IX

4.6.52 Removal from glass plate

A pocket knife or the point of a pen-knife blade is used to lift one corner of the tissue from the glass support where it should then be easily stripped from the glass (Bolas, 1878)^[82]. No noticeable difference was observed in removing the tissue from a plate with a release agent applied.

4.6.53 Storage of tissue

Tissue must be stored in a light proof box as UV light will spoil the tissue when dry. The tissue at this stage will absorb moisture and must be kept dry. In some instances the tissue was wrapped in tinfoil or a waterproof material prior to being placed into the printing frame for exposure in order to protect it from damage caused by moisture. (Photographic News, 1883)^[83] In this study tissues were placed in a light safe bag and stored in a plans chest that was kept in a photographic storage dark room.

From personal observation it was found that sensitized tissue that was stored was problematic due to the dark effect. Tissue that was stored for more than 5 days after sensitising could not be used. In this study the practice was to sensitize, dry, expose and develop within a 24 hour period to maintain consistent results.

82 Bolas, T. (16/08/1878) Extract - The Application of Photography to the Production of Printing Surfaces and Pictures in Pigment. Photographic News. XXII

83 Unknown (16/11/1883) The Woodbury Process: Second Article. Photographic News. XXVII

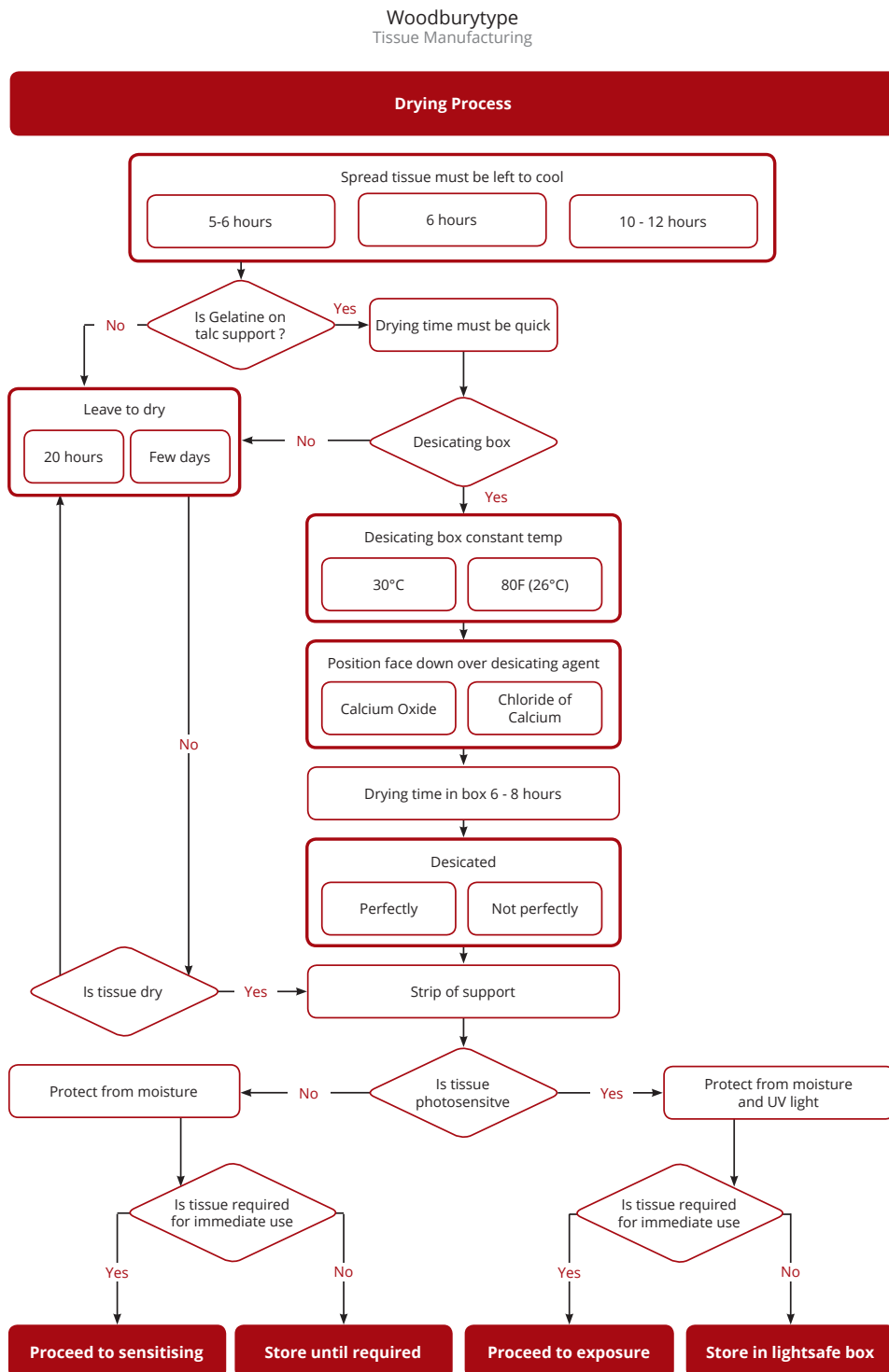

Figure 4.19 Drying

4.7 Stage 3 – Photographic exposure

4.7.1 Preparation of tissue for photographic exposure

The photosensitized tissue is ready for exposure once it has been dried and is stripped from the glass support. The collodion side of the tissue (the surface that was placed against the casting support) is lightly dusted with French chalk or talc and then brushed clean with a camel hair brush. There must be no residue or moisture on the tissue, as it will damage the collodion coating on the negative. The negative is placed against the collodion face of the tissue as this is the wash support that will hold the developed image later. The exposure is always through the negative. In this study the negatives were placed inside 30µm clear photographic bags to prevent accidental damage from the gelating on the negative. Makeshift printing frames could be made by sandwiching the negative and the tissue between two sheets of glass held together by rubber bands (Woodbury, 1865).^[84] A Perspex frame, cardboard and alligator clips can be used as a makeshift frame.

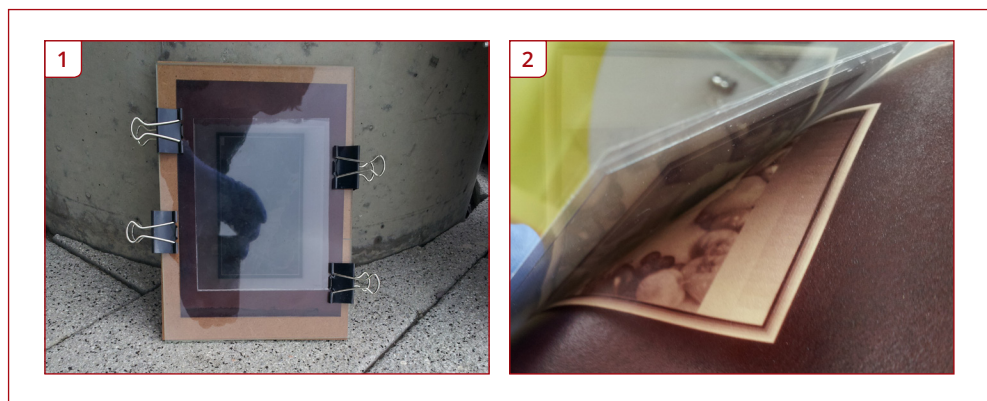

Figure 4.20 Home made exposure frame used in Albumen printing

The exposure of negatives and tissues can be made with either natural sunlight or artificial light. The gelatine and the negative were masked off within the printing frame to ensure sharp edges when developed and to avoid stray light damaging the exposure. The tissue was only exposed on one side and was positioned parallel to or facing a fixed light source to avoid distortion in the exposure.

84 Woodbury, W.B. (18/08/1865) The New Photo-Relief Printing Process In Semi-Transparent Ink. Photographic News. IX

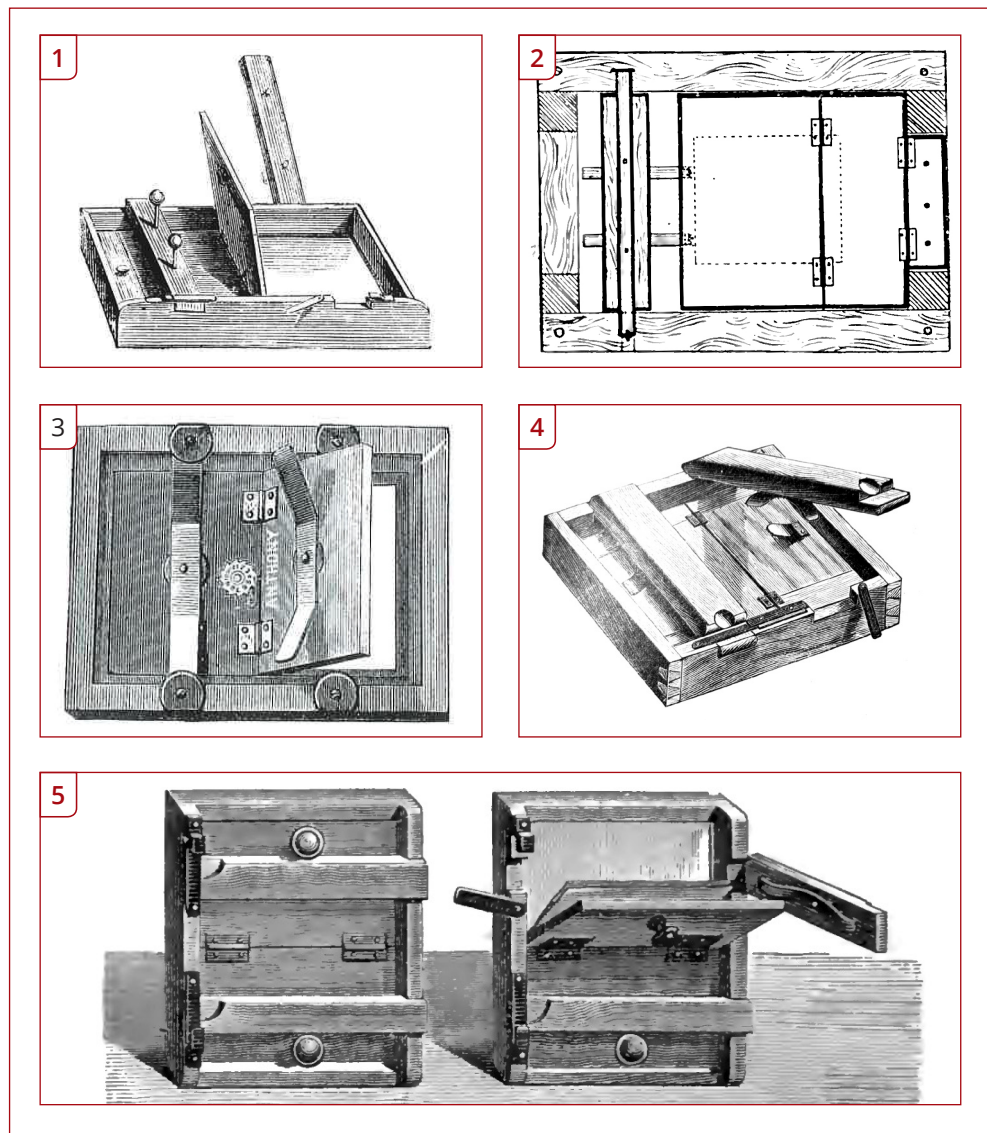

Figure 4.21 Exposure / printing frames

4.7.2 Sunlight

While sunlight was freely available the exposure times could not be consistent as it was dependent on the environmental conditions. The intensity of the light used in sun-exposures is very dependent on the location, weather, time of day, and the season. All of which can create variable conditions that extend exposure times or prevent it taking place. Overcast dull days will require more time than clear sunny days and summer afternoons will take less time than winter afternoons etc. Multiple negatives can be exposed simultaneously, limited only to the number of exposure frames that you have available and the space available to place them.

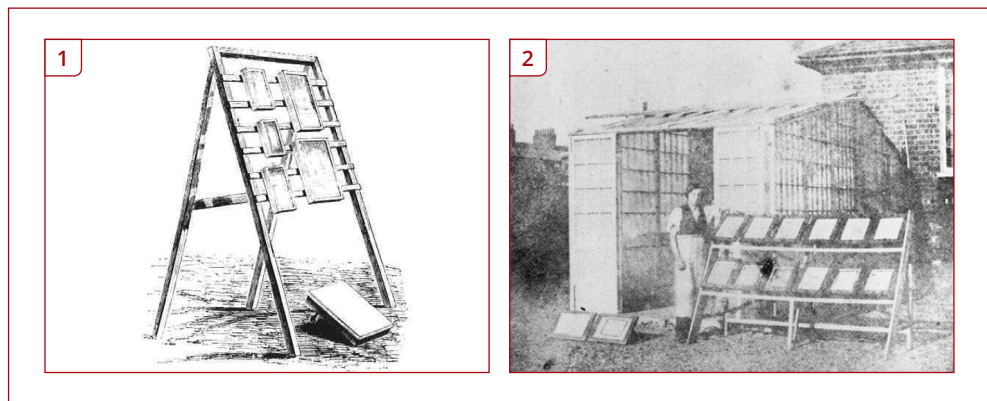

Figure 4.22 1) Exposure frames on rack 2) Exposure frames in use. Reading Establishment, c 1844-1877 by Nicolas Henneman. Copyright © Science Museum Library / Science & Society Picture Library

4.7.3 Optical exposure aids

Solar cameras (daylight enlargers) were used to expose the image by focusing direct sunlight through a condensing lens^[85] onto the exposure frame.

Enlargers are generally separated into two types: condenser and diffusion. Condenser enlargers concentrate the light source and direct it straight through the negative by one or more condensing lenses. These produce sharply focused images with more contrast than images from diffusion enlargers. Scratches and defects on a negative are more difficult to disguise when using a condenser enlarger.

Diffusion enlargers employ the use of a diffusion screen. Diffusion enlargers scatter the light so that it is not traveling in parallel rays when it hits the negative and softening of the focus of the image. (Allred Redman, 2006)^[86] This study used acetate sheets as a diffusion screen between the half-tone negatives and the tissue. This aided in the obscuring of a half-tone dot structure pattern on the exposure.

The solar camera exposure method allowed for quicker times than outdoor solar exposure. The tissues were exposed indoors in specially adapted rooms that had access to sunlight through daylight apertures and optical lenses. The number of potential exposures were only restricted to the number of negatives that could be placed into the focus of light on the lens.

⁸⁵ Newhall, B. (1964) *The History of Photography*. 1st ed. New York: The Museum of Modern Art, New York.

⁸⁶ Allred Redman, J. (2006) Enlarger. In: Warren, L., ed. (2006) *Encyclopedia of Twentieth-Century Photography* Volumes I-III. Routledge, pp.443-444.

Printing frames were placed approximately 18-24 inches in front of the lens to avoid accidental damage to the negative by melting the gelatine tissue. Exposures with condensing lenses relied on natural light and later allowed for artificial light exposures.

4.7.4 Artificial light sources

Artificial light from gas or electric sources enabled the controlling of exposure times as the intensity of the light source could be regulated (Sutton, 1870)^[87]. As electricity became more and more accessible exposure of negatives was no longer limited to daytime. The use of electric light was in its infancy and not without health risks. Walter Woodbury suffered injury to his eyes in an incident that almost cost him his sight by using an arc light for an exposure unit. Electrical lights would have allowed a consistent rate of output and known exposure times allowing for production independent of sunlight.

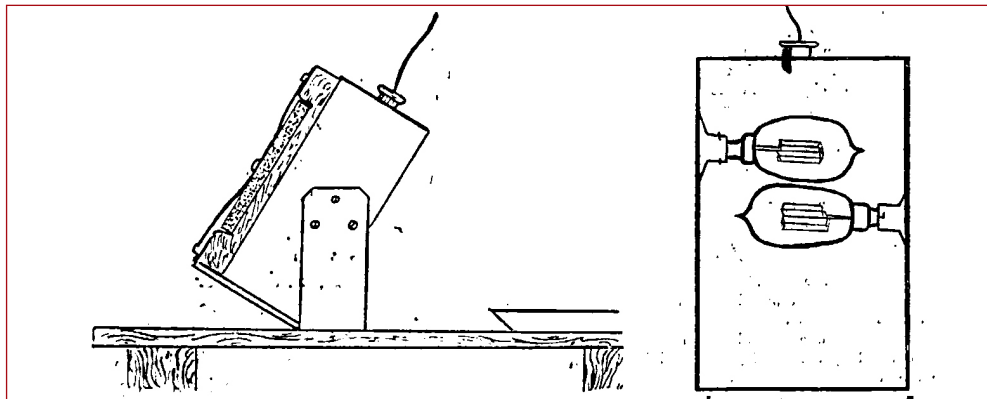

Figure 23 Artificial gas light source illustration published in British Journal of Photography

The empirical investigations within this study employed the use of a UV exposure unit with a vacuum bed. While this had obvious benefits of a consistent light source it also had several drawbacks. The heat from the unit in long exposures was enough to melt the tissue causing the emulsion layer of the negative to stick to it. This resulted in a negative that was damaged and could no longer be used.

⁸⁷ Sutton, T. (01/03/1870) A Week at the Woodbury - Printing Establishment of MM. Goupil at Ansieres, near Paris. The Photographic Art Journal.

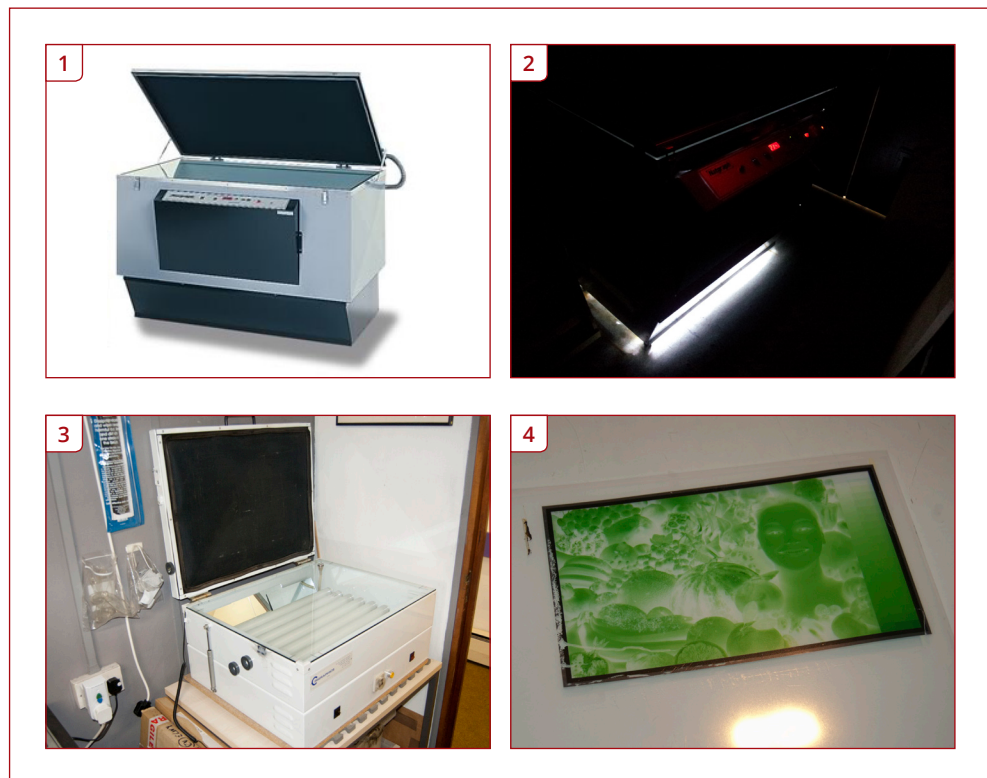

Figure 4.24 1)Exposure cabinet 2)Exposing the negative 3)Exposure unit 4)Negative damaged in exposure

4.7.5 Exposure times

Multiple variables contribute to the length of the exposure time: the type of negative, the concentration of sensitizer, the type of sensitizer, the age of the sensitizer, the thickness of the tissue, if the tissue is pigmented, and the UV light source. It should be no surprise that there was a large variance in the reported exposure times of the negative. Exposure times in historical reports varied in extreme from 12 minutes in a bright day (Photographic News, 1883)^[88] to a full day in dull weather (Photographic News, 1883)^[89]. Most details claim exposures between 30-60mins (Woodbury, 1865)^[90], 60-120mins (British Journal of Photography, 1865)^[91] to 120-240mins (Sutton, 1870)^[92]

⁸⁸ Unknown (16/11/1883) The Woodbury Process: Second Article. Photographic News. XXVII

⁸⁹ Unknown (16/11/1883) The Woodbury Process: Second Article. Photographic News. XXVII

⁹⁰ Woodbury, W.B. (12/05/1865) New Patent: Complete Specification of Patent Obtained by Walter Bently Woodbury, Manchester, filed 23rd March, 1865. British Journal of Photography. XII

⁹¹ Unknown (25/08/1865) Printing Photographs from Metal Plates. British Journal of Photography. XII

⁹² Sutton, T. (01/03/1870) A Week at the Woodbury - Printing Establishment of MM. Goupil at Ansieres, near Paris. The Photographic Art Journal.

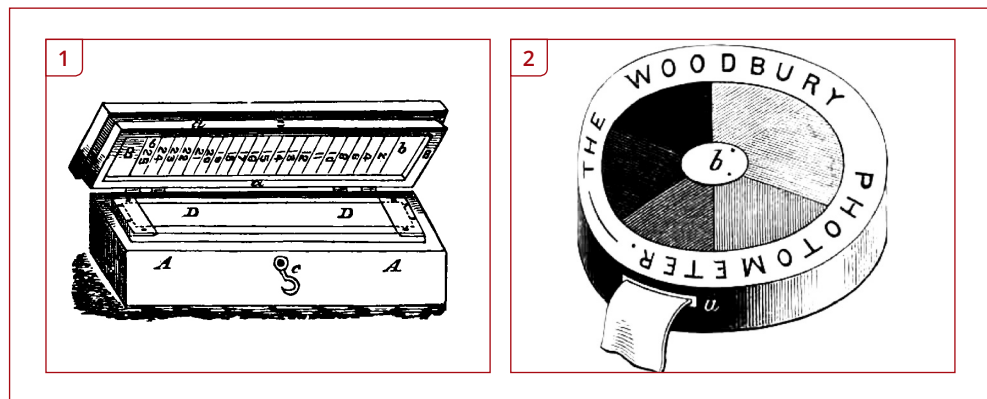

Figure 4.25 1) Vogels Photometeter, published in *The American Carbon Manual*, Wilson, Edward A. (1868). 2) Woodbury Photometer, published in

Potassium dichromate is not as photosensitive the ammonia dichromate^[93] and as such will have longer exposure times.

Articles describing exposure state it was primarily determined successful or complete by visual assessment with very little emphasis being given to photometers or actinometers (although they were introduced to the process later on). Once the exposure was started it was best advised not to open the back of the printing frame in sunlight to avoid spoiling the exposure, which indicates that either experience is a key factor in knowing the exposure time or it was being monitored somehow.

Artificial light and consistent methods of tissue production will reduce the variables. This allows for consistently repeatable exposures and timings within companies capable of large-scale production such as MM Goupil et Cie which employed a breakdown of tasks, with specific tasks assigned to individual departments.

In this study a 21 step wedge was used to expose tissue. Through a visual assessments the exposure time was determined when all 21 tonal steps could be clearly identified. Times and settings that worked perfectly one day might not suitable three or four days later. To eliminate this variable fresh chemicals were used to sensitize tissues on the day of use.

The exposure of tissue in this study was 480 units (8 minutes). It must be noted that as the bulb ages light intensity decreases. This time will also vary according to manufacturer.

⁹³ NADEAU, L., 1986. *Modern carbon printing: a practical guide to the ultimate in permanent photographic printing: monochrome carbon transfer and carbro*. Fredericton, New Brunswick: Atelier Luis Nadeau.

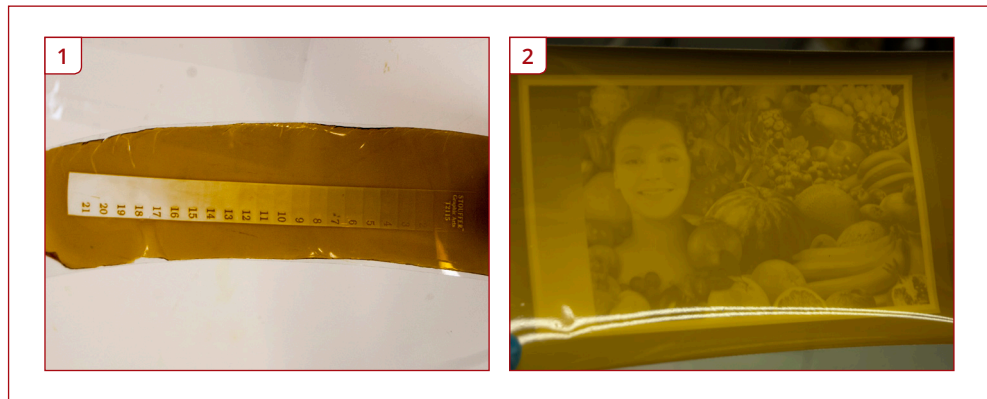

Figure 4.26 1) Stoufer wedge 2) Test image with step wedge incorporated into the design.

4.7.6 Over and under exposure

If the light penetrated too far into the gelatine it would produce an over exposure. If the light did not penetrate far enough, under exposure occurred. Controlling the chemicals and the light settings on modern equipment can control this variable.

4.7.7 Removal from printing frame

After being exposed the printing frames were opened (or vacuum beds released) and the tissue separated from the negative within a darkroom to avoid additional exposure with stray light.

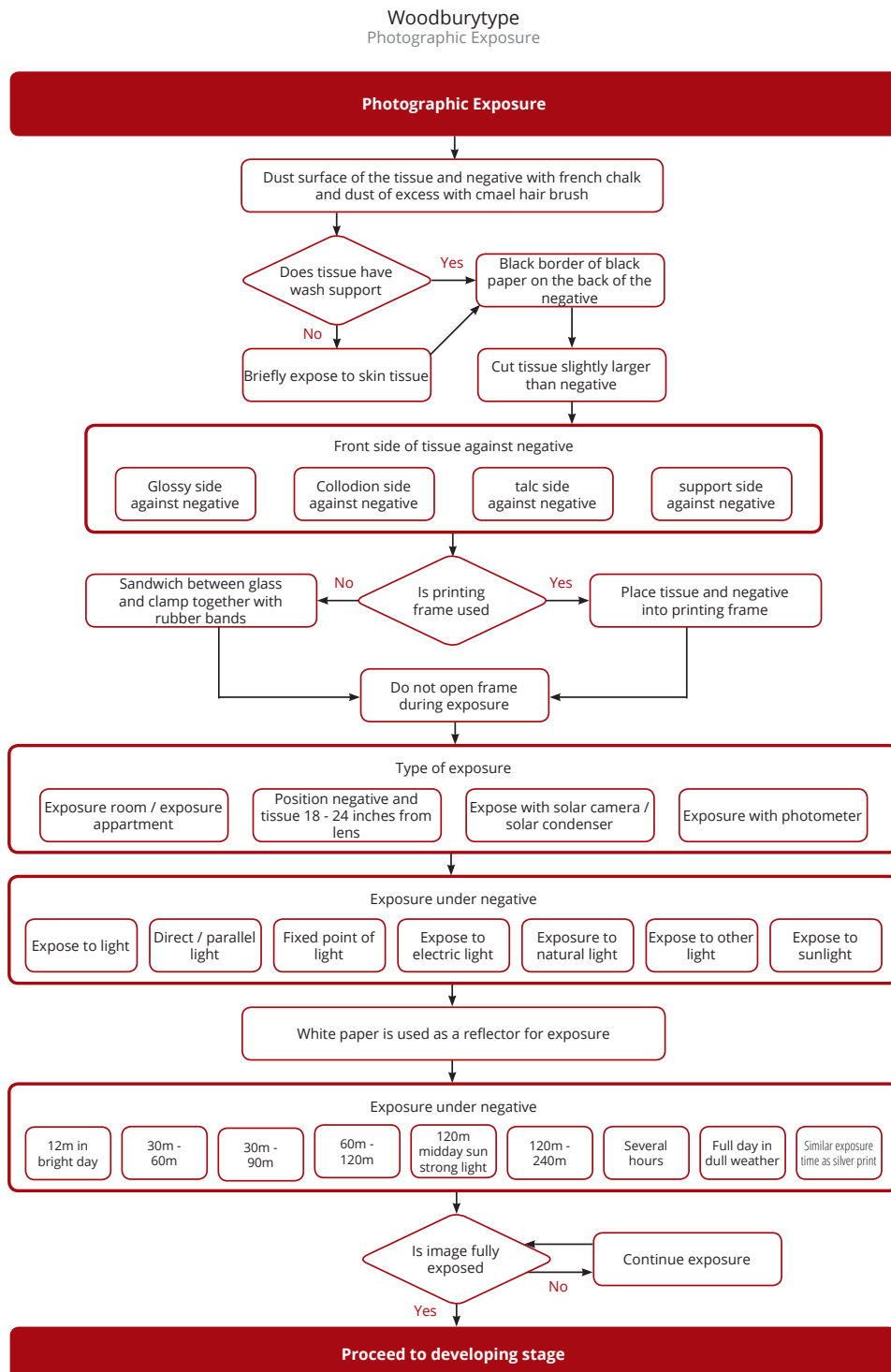

Figure 4.27 Photographic exposure

4.8 Developing - Stage 4

This development process is also referred to as “washing out” due to the unexposed tissue being washed out of the photorelief.

4.8.1 Washing Supports

The tissue must be adhered to a washing support after exposure and before the developing stage. Washing supports must be smooth, flat, rigid substrates that are waterproof. Glass was the preferred support (Waterlow, 1888)^[94] but a lacquered piece of stiff card could also be used (Woodbury 1865)^[95]. Collodion and Goldbeaters skin were mentioned but no reports were found on how successful these methods were.

The tissue is still photosensitive and should be protected from stray UV light as it will damage and ruin the exposure. In a darkroom the gelatine is washed in water to develop the image. The exposed tissue is still hydrosopic, ie it will absorb moisture, swelling in size as it does.

The UV light has caused the cells within the exposed areas of the tissue to cross-link and tan. It is now structurally changed. The tissue will not be affected by temperature or moisture in the same way as the unexposed areas of the same tissue. When exposed to water the unexposed areas will start to dissolve and wash away leaving behind the exposed areas.

When fully hydrated the tissue is flexible and feels similar to rubber. Without the aid of a washing support it is extremely difficult to develop the tissue and avoid accidental damage. An unsupported tissue will curl and distort as it is developed, and it will be impossible to dry in a flat undistorted state ruining the tissue and rendering it unusable.

4.8.2 Preparation of the wash support

As with the casting stages the wash support must be clean, free from dirt or grease and on a level surface. An adhesive that will not cause damage to the tissue must be used. India Rubber, a natural latex was commonly used for this process (Tissandier, 1876)^[96]. The rubber was mixed with benzole or a similar solvent (enabling it to flow more freely) and this was poured smoothly onto the support surface (Sutton, 1870)^[97]. The

⁹⁴ Waterlow, G.S. (30/03/1888) Modern Photographic Engraving and Printing (Part 2). Photographic News. XXXII

⁹⁵ Woodbury, W.B. (12/05/1865) New Patent: Complete Specification of Patent Obtained by Walter Bently Woodbury, Manchester, filed 23rd March, 1865. British Journal of Photography. XII

⁹⁶ Tissandier, G. (01/01/1876) A History and Handbook of Photography (Part II, Chapter II). A History and Handbook of Photography.

⁹⁷ Sutton, T. (01/03/1870) A Week at the Woodbury - Printing Establishment of MM. Goupil at Ansieres, near Paris. The Photographic Art Journal.

India rubber could also be gently warmed so that it became more viscous and easier to spread onto the support. The support was left for up to two hours so that the adhesive could set and become ready to receive the tissue.

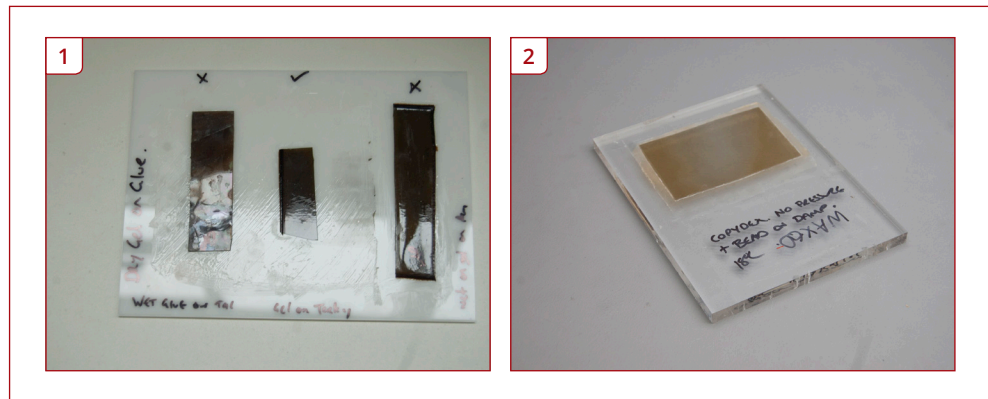

Figure 4.28 Adhesive tests done in this study 1) Elmers glue 2) Copydex latex adhesive

The collodion side of the tissue (which is the back of the image) is placed in even contact with the adhesive on the support (Sutton, 1870)^[98]. Pressure is applied either with a squeegee, by hand or by placing a sheet of paper on top of the tissue and running the sandwich of support, tissue and paper through a wringing machine with a set of India Rubber rollers or similar (Photographic News, 1884)^[99].

The core method used in this historical study did not require adhesion to a wash support. Tissues were cast onto acetate film. Once the tissue was washed out and dried the developed photo relief simply peeled off undamaged. Doing so removed a step in the traditional process.

⁹⁸ Sutton, T. (01/03/1870) A Week at the Woodbury - Printing Establishment of MM. Goupil at Ansieres, near Paris. The Photographic Art Journal.

⁹⁹ Unknown (21/03/1884) The Woodbury Process: Third Article. Photographic News. XXVIII

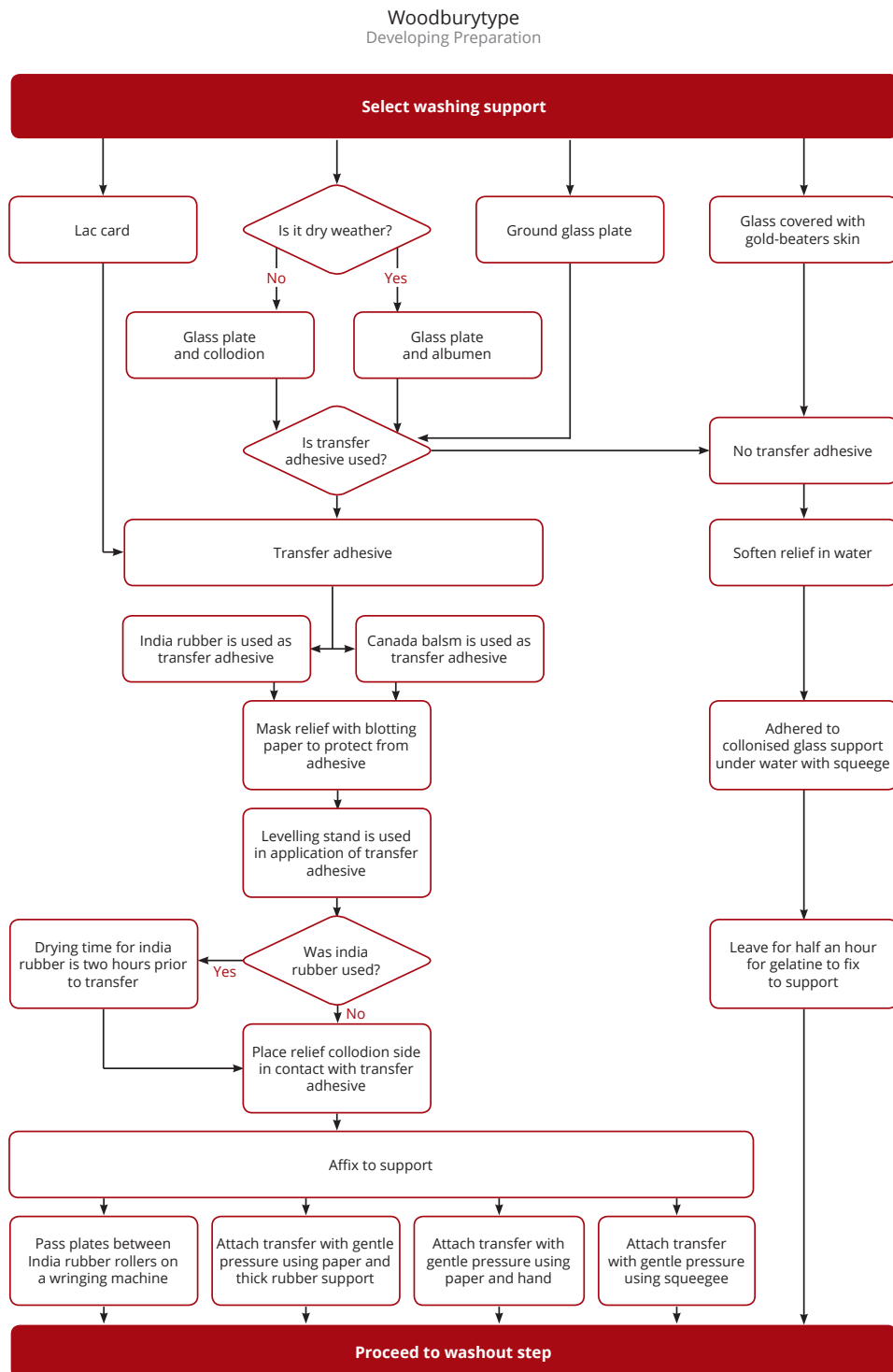

Figure 4.29 Washing support

4.8.3 Washing out

Water is the developing agent used. The tissue is placed in a water bath to dissolve the unexposed gelatine leaving the exposed areas intact as a photo-relief. As the relief absorbs moisture it is susceptible to being damaged. Care must be taken to avoid rough handling.

The development process is complete when the unexposed areas are washed away.

There are multiple variances in the details of the washing out stage. Variables such as sensitizer strength, sensitizer freshness, volume of gelatine in the tissue and thickness of the tissue has a direct effect on the water temperature, time and agitation of the tissue needed during the process.

4.8.4 Water bath

Reports state that the tissue is left in a warm water bath to begin development (Photographic Journal 1865)^[100]. The bath was described as being zinc and with a grooved base (Photographic News, 1884)^[101]. This study found that leaving the tissue in cool room temperature water so that it can absorb the water and swell before developing worked better. Once the tissue has swollen it was typically transferred to hot water to start developing the image.

This study used standard 24 inch plastic photographic developing trays. It is much easier to develop the image in a white tray (the trays come in a range of colours to help identify various photographic chemicals in low light such as stop baths, fixers and developers). When developing the tissue in a coloured washout tray in low light conditions (especially if using a safelight) it is extremely difficult to see the relief being developed. Development in a white tray aids visibility in low light conditions. For ease of use, two trays are recommended when changing water or temperature.

4.8.5 Developer temperatures

For the tissue to develop it needs to be washed well in hot water (The Lithographer, 1874)^[102]. The temperature of the washing out water varied from cold water to almost boiling water (British and Colonial Printer and Stationer, 1893)^[103]. That could potentially be a difference of 1°C to 100°C and really is of no practical use. Other reports mention that the water should be as hot as the hand can bear (Woodbury,

¹⁰⁰ Unknown (15/12/1865) Mr. Woodbury's Photo-Relievo Process. The Photographic Journal.

¹⁰¹ Unknown (21/03/1884) The Woodbury Process: Third Article. Photographic News. XXVIII

¹⁰² Unknown (15/01/1874) The Correlation of Photography, Lithography, and Typography: The Woodburytype Process. The Lithographer.

¹⁰³ Unknown (13/04/1893) Extract - Messrs. Waterlow & Sons' Photo-Mechanical Printing Works. British & Colonial Printer & Stationer. XXXI

1865)^[104] which could again be any temperature from 20°C to above 50°C and completely dependent on the user.

Initially the water the tissue is soaked in should be cool and then the temperature raised during the washing. Two specific practical temperatures were given for the final washing temperature giving a useable temperature range between 40°C and 65°C. The water temperature can be maintained by changing the water routinely or flowing water into the developing tray at a consistent temperature.

Warm water will dissolve the unexposed gelatine quicker than cold. The strength of the gelatine will affect the water temperature needed to develop the image. A tissue with a weaker volume of gelatine will dissolve in cooler temperatures. If the temperature is too hot it will damage the tissue.

35°C - 40°C was the preferred temperature range used in this study. Temperatures in excess of 45°C caused issues by damaging the surface integrity of the gelatine. Temperatures exceeding 50°C also caused several instances of the tissue to releasing from the acetate support while developing the image.

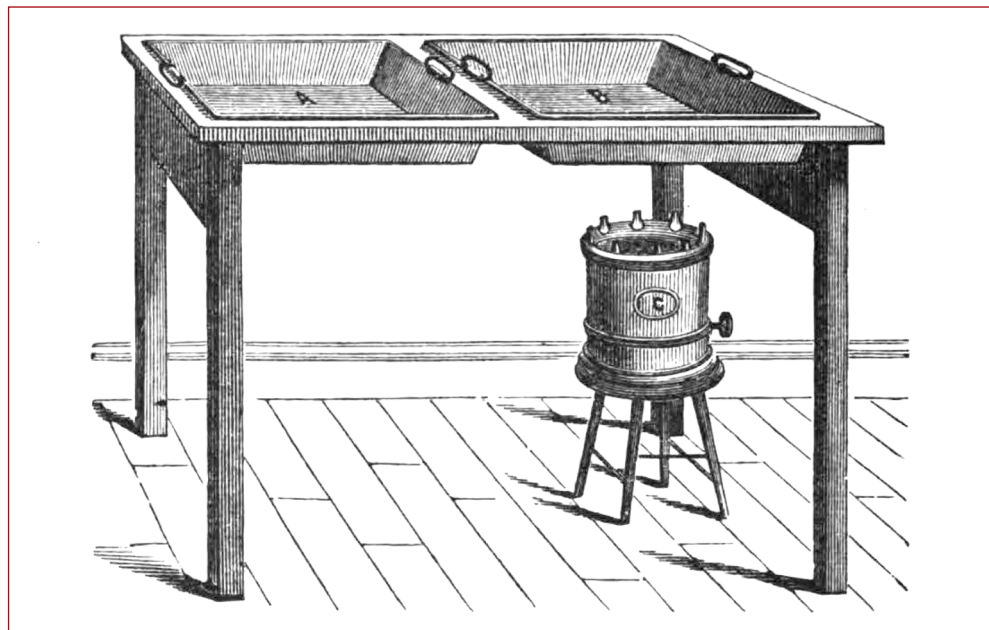

Figure 4.30 Developing tray and heater used for washing out / developing carbon tissues, published in *The American Carbon Manual*, Wilson, Edward A. (1868)

104 Woodbury, W.B. (18/08/1865) *The New Photo-Relief Printing Process In Semi-Transparent Ink*. *Photographic News*. IX

4.8.6 Developing times

Developing time reports ranged greatly from 10 minutes (Woodbury, 1865)^[105] several hours, (Waterlow, 1888)^[106] half a day, a full day (Sutton, 1870)^[107] and up to several days. Cold water descriptions involved leaving the tissue in water until unexposed areas dissolve over long times. Tissue that was sensitized with fresh chemicals developed quicker than tissue that used older chemicals or had been sensitized and stored for a few days before use. Tissues that were exposed to the wash bath for excessive times also damaged the tissue.

The washing out stage is complete when the collodion support is exposed (which was described as being opalescent), when the washing water is rinsing out clean, or all of the unexposed gelatine (Amateur Photographer, 1887)^[108] or unexposed gelatine is washed away (Woodbury, 1867)^[109].

This study observed that it took between 30 to 40 minutes to develop one image at 40°C. Increasing the temperature to near 45°C decreased the time needed only very slightly, but increased the risk of accidentally damaging the relief.

To prepare the tissue for developing it was soaked in a tray of cool water 15 minutes to swell it. Once swelled, it was placed in a bath of warm water to begin the development.

4.8.7 Development aids

Gentle agitation of the tissue expedites the development, as will flowing water across the surface of the tissue. Water can be flowed across the image through the use of pipettes. This aids in the exposure of fine details of the tissue by directing the flow of water to a specific area of the relief. This technique can be used to selectively control the development of shadows and mid-tones in areas where there may be a slight photographic overexposure. Do not subject the tissue to large volumes of fast flowing water, such as from a tap, hose pipe, or pouring on directly to the surface. Too much agitation will damage the tissue and may cause frilling where fine detail lifts up around the edges of the image.

105 Woodbury, W.B. (18/08/1865) The New Photo-Relief Printing Process In Semi-Transparent Ink. *Photographic News*. IX

106 Waterlow, G.S. (30/03/1888) Modern Photographic Engraving and Printing (Part 2). *Photographic News*. XXXII

107 Sutton, T. (01/03/1870) A Week at the Woodbury - Printing Establishment of MM. Goupil at Ansieres, near Paris. *The Photographic Art Journal*.

108 Unknown (03/06/1887) Fifty Years Development of the Graphic Arts. *Amateur Photographer*. V

109 Woodbury, W.B. (1867) On a Method of Obtaining Imperishable Photographs. *British Journal Photographic Almanac and Photographer's Daily Companion*.

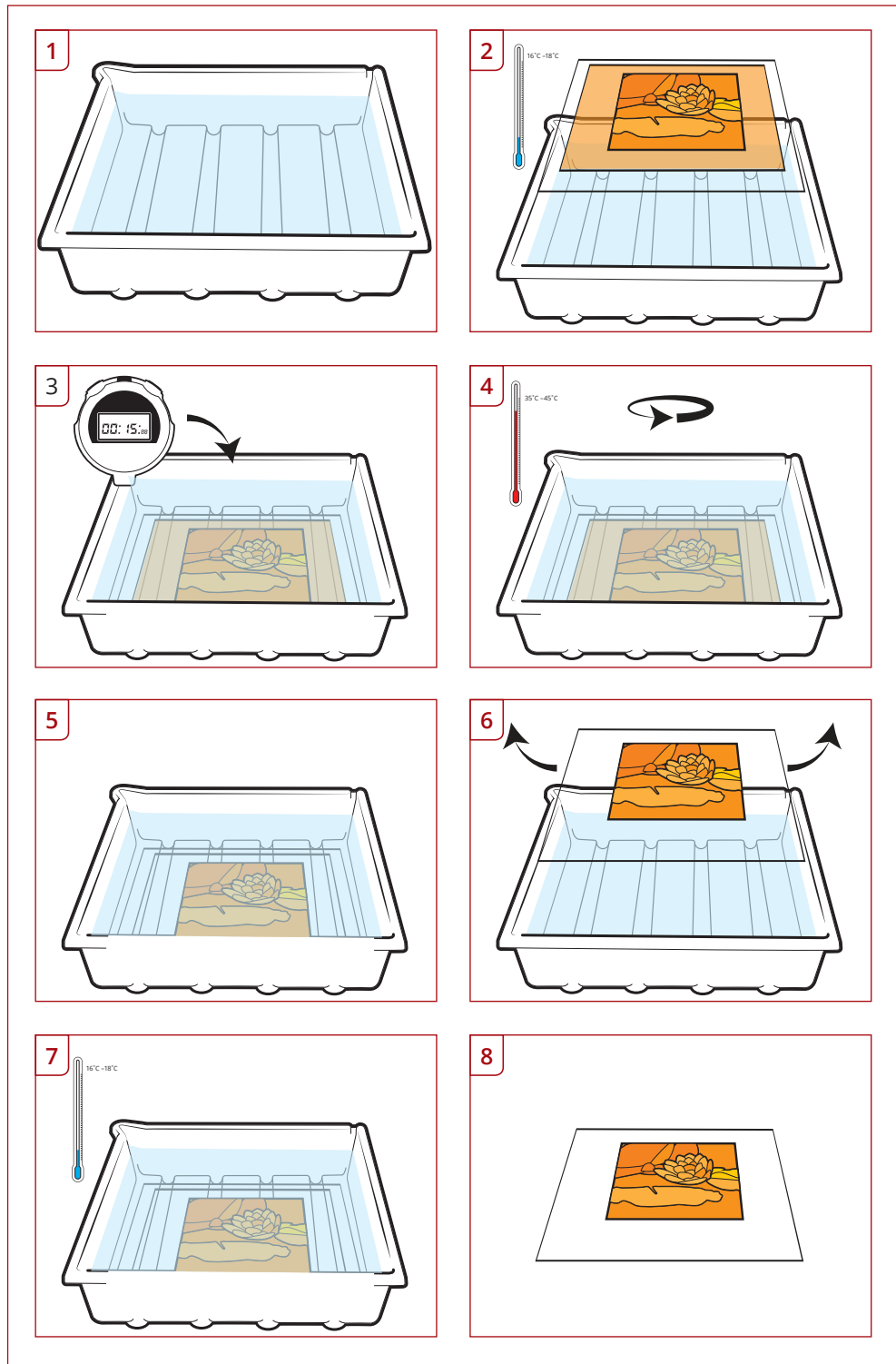

Figure 4.31 The developing process

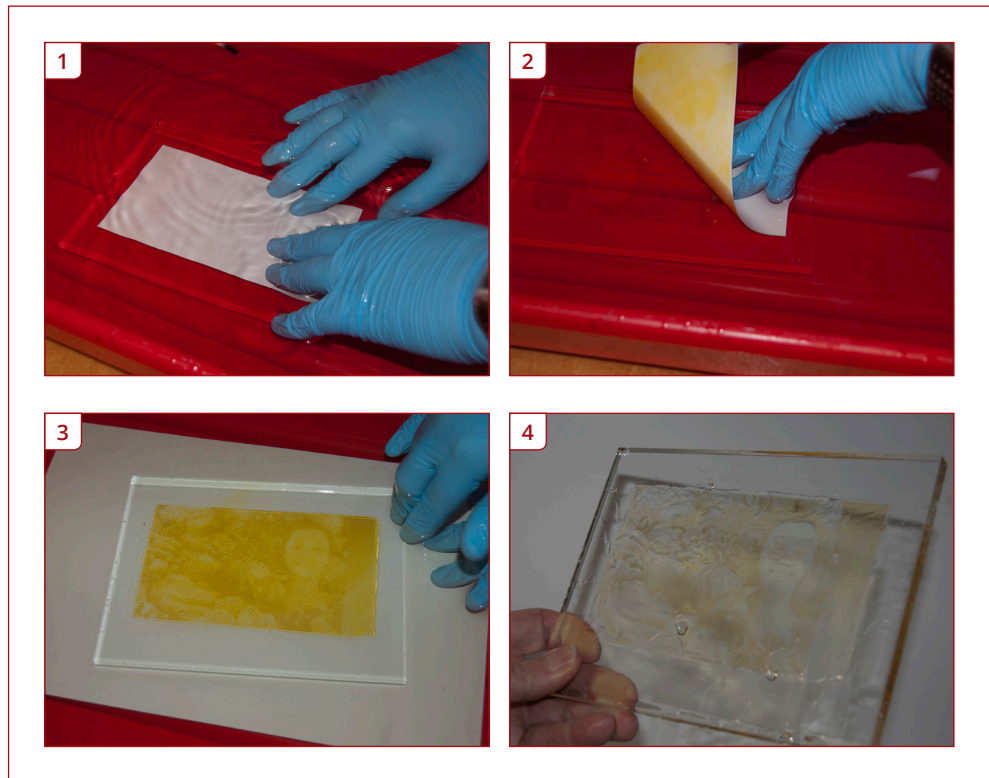

Figure 4.32 Mating relief to a rigid plastic support, as per carbon double transfer.

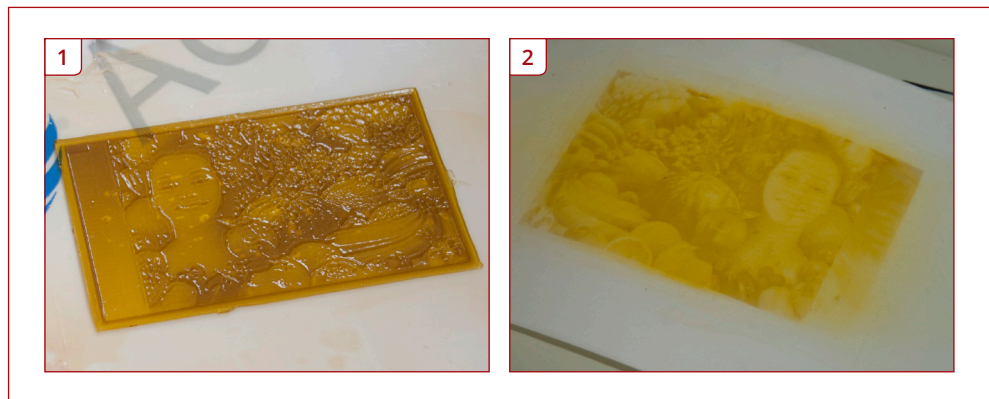

Figure 4.33 1) Developed relief adhered to rigid support with latex gum adhesive 2) Relief developed on a paper wash support.

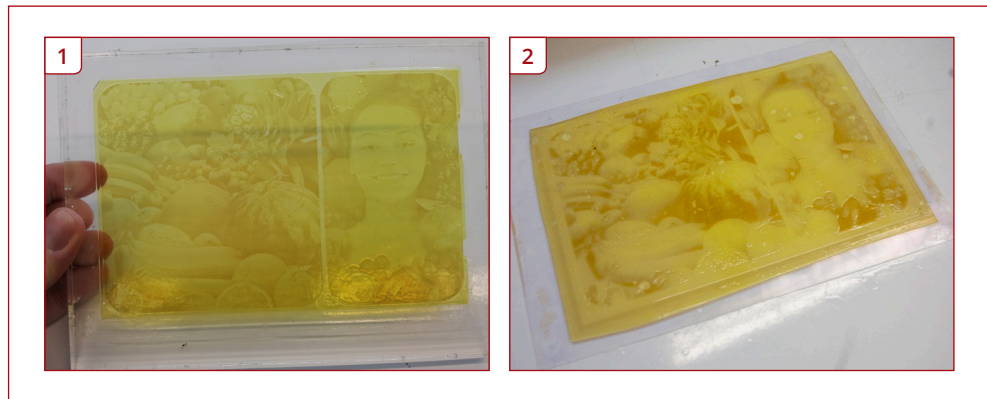

Figure 4.34 1) Relief developed on a rigid support 2) Relief developed on a flexible acetate support

4.8.8 Finishing the developing

Once washed out and developed to a level of satisfaction the tissue is submerged or rinsed with clean cold water (Lithographer, 1874)^[110]. This halts the melting or softening of any unexposed gelatine that you may wish to retain for aesthetic purposes such as increasing the mid tones and shadows. Once cooled the tissue while still attached to the support is placed onto a drying rack (Photographic News, 1824)^[111] to let excess water run off.

4.8.9 Sharpening the image (optional)

The image relief was reported to have been submerged into an alcohol bath (British and Colonial Printer and Stationer, 1893)^[112]. Methylated spirits was commonly used. Water within the swollen gelatine is drawn out and it is replaced with the alcohol in a process called capillary action. When removed from the alcohol bath the alcohol evaporates from the tissue speeding up the drying time. This process was said to sharpen the fine details within the tissue but there was no observation made in this study to verify this claim as the details were already fixed due to photo exposure.

Bathing times reported were between 15 minutes and 3 hours (British and Colonial Printer and Stationer, 1893)^[113]. No advantage to using an alcohol bath was observed. What was observed was that it could cause areas of the relief to dry at slightly different rates due to the variable thicknesses contained within the relief's tonal range. This caused uneven drying on the relief and risks causing a warp or distortion in the relief.

¹¹⁰ Unknown (15/01/1874) The Correlation of Photography, Lithography, and Typography: The Woodburytype Process. The Lithographer.

¹¹¹ Unknown (21/03/1884) The Woodbury Process: Third Article. Photographic News. XXVIII

¹¹² Unknown (13/04/1893) Extract - Messrs. Waterlow & Sons' Photo-Mechanical Printing Works. British & Colonial Printer & Stationer. XXXI

¹¹³ Ibid

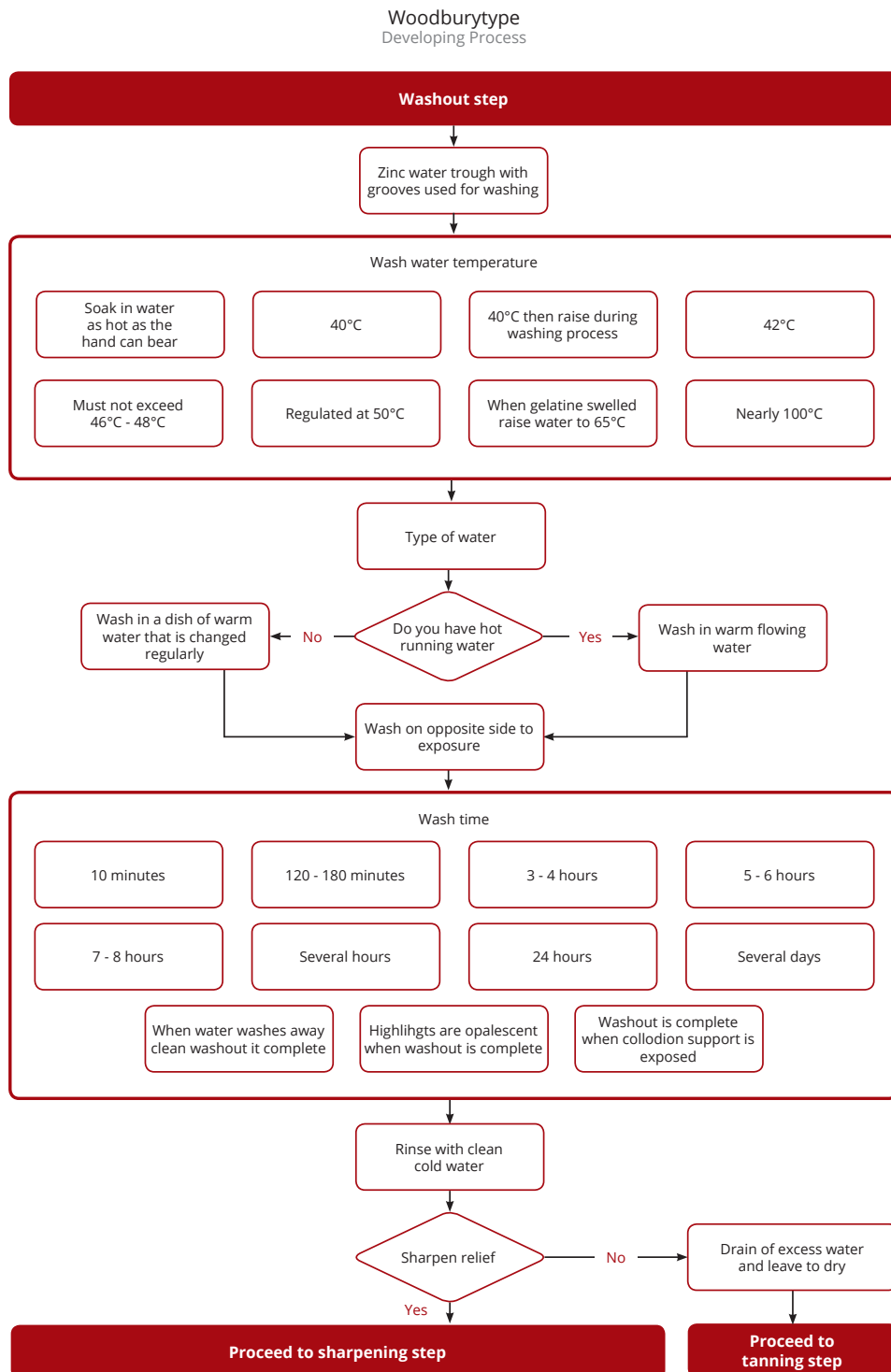

Figure 4.35 Washout

4.8.10 Manually painting a matrix (alternative relief production)

An artist's rendering could be used to create the relief. Using a solution of gelatine that is pigmented with Indian ink to the same strength as the final printing ink, an image is brushed onto a glass plate with a collodion base layer (Woodbury, 1870)^[114]. When dry, soak with dichromate and leave to dry. Expose to a UV light source to tan the image and treat with chrome alum. This method was not tested within this study.

4.8.11 Hardening the image

After drying the relief it is crucial that the gelatine is made hydroscopic to stop it re-absorbing moisture and protecting the photo-relief to changes in humidity. This is achieved by bathing in chrome alum (Photographic News 1884)^[115]. Alum was first used and patented in hardening gelatine films by Joseph Swan^[116]. Chromium potassium sulphate (Sigma-Aldrich)^[117] or Chrome Alum $\text{KCr}_2(\text{SO}_4)_2 \cdot 24\text{H}_2\text{O}$ is a trivalent chromium CrIII and is slightly toxic (Saha, Nandi, Saha, 2011)^[118]. The relief is submerged for 5 minutes in the bath. This is essential in the making of the printing plates as the gelatine relief must be completely dry and hard for this stage of the process. The alum spoils quickly and cannot be stored in a bottle. It needs to be changed twice a day (Nadeau, 1986)^[119]. Prepare only the amount of chrome alum solution needed. Once bathed in alum rinse briefly in cold water and leave to dry.

In this study acetate was the main casting and wash support. It was oversized to the tissue required. Once the tissue was developed into a photo relief, the acetate has to be fastened to a rigid support with clips. This is due to the gelatine contracting as it dries and the acetate being flexible. If the acetate is not clipped to a rigid plastic support it will curl naturally with the tissue (See Figure 4.38) .

¹¹⁴ Woodbury, W.B. (25/02/1870) Recent Patents - Photo-Relief Printing. Photographic News. XIV

¹¹⁵ Unknown (21/03/1884) The Woodbury Process: Third Article. Photographic News. XXVIII

¹¹⁶ Unknown (1872) Photography in the Printing Press. The Photographic Journal. 15 (January 15), pp.108-113.

¹¹⁷ SIGMA-ALDRICH Chromium(III) Potassium Sulfate Dodecahydrate. Safety Data Sheet.

¹¹⁸ Saha, R., Nandi, R. and Saha, B. (2011) Sources and toxicity of hexavalent chromium. Journal of Coordination Chemistry. Vol 64, No 10 (20 May 2011), pp.1782-1806.

¹¹⁹ Nadeau, L. (1986) Modern Carbon Printing: A Practical Guide to the Ultimate in Permanent Photographic Printing: Monochrome Carbon Transfer and Carbro [online]. Fredericton, New Brunswick: Atelier Luis Nadeau.

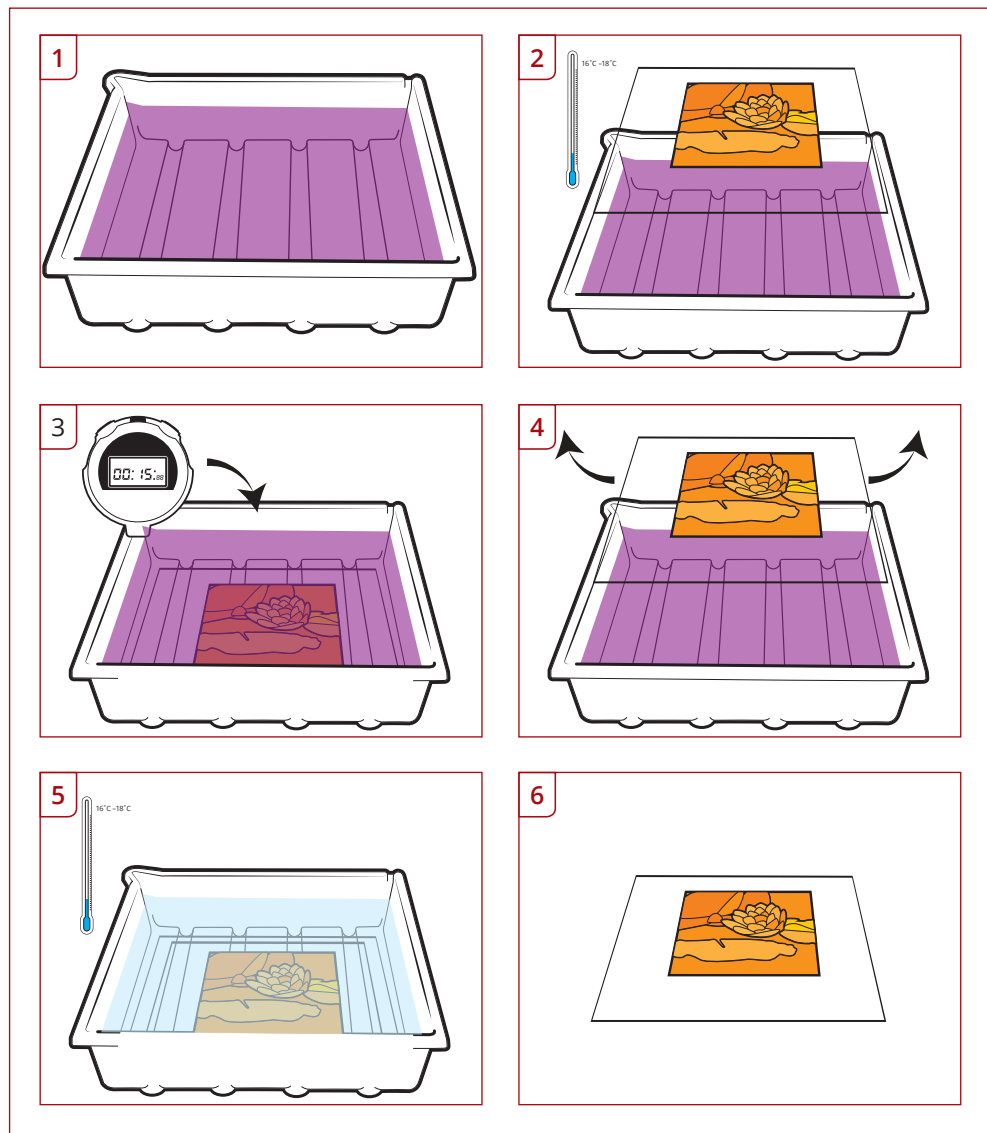

Figure 4.36 Hardening the image 1) 2) 3) 4) 5) 6)

4.8.12 Alternatives to Chrome Alum

Formalin can be used as an effective hardener. It is toxic and a suspected carcinogen. It is an aqueous solution of formaldehyde HCHO (Nadeau, 1986)^[120].

¹²⁰ Nadeau, L. (1986) Modern Carbon Printing: A Practical Guide to the Ultimate in Permanent Photographic Printing: Monochrome Carbon Transfer and Carbro [online]. Fredericton, New Brunswick: Atelier Luis Nadeau.

4.8.13 Chrome Alum

This study used a 12% chrome alum solution to harden the relief.

4.8.14 Removal from support

Once the relief has been tanned and dried it can be removed from the glass support. Do not remove from the support if the printing plate is being manufactured by electrodeposition (Woodbury, 1865)^[121] (explained in section 3.6.1).

The rubber adhesive can be peeled and rubbed off the relief (Tissandier, 1876)^[122].

For the acetate method used in this study, a corner of the tissue can be lifted and the whole relief will come away quite easily and without distortion as no adhesive is used.



Figure 4.37 1) Developed matrix wet 2) Dry matrix removed from wash support

¹²¹ Woodbury, W.B. (12/05/1865) New Patent: Complete Specification of Patent Obtained by Walter Bently Woodbury, Manchester, filed 23rd March, 1865. *British Journal of Photography*. XII

¹²² Tissandier, G. (01/01/1876) *A History and Handbook of Photography (Part II, Chapter II)*. A History and Handbook of Photography.

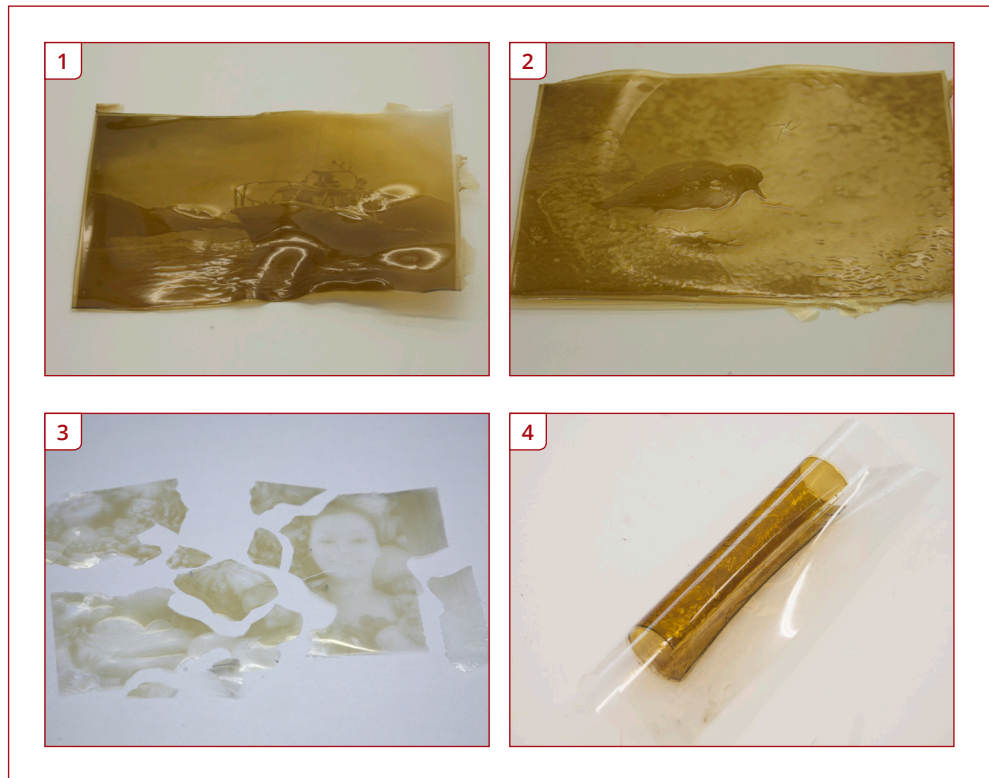

Figure 4.38 Damaged Matrices 1)Relief damaged due to frilling during developing 2) Relief thickness dried at different rates 3) Relief broke after drying due to rough handling 4) Flexible support dried in drying cabinet with temperature too high and too fast.

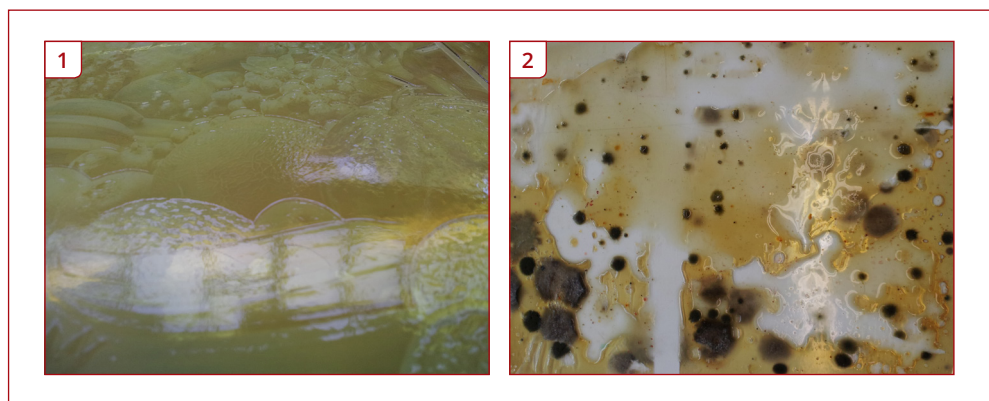

Figure 4.39 1) Relief generated through the Chiba method. (4.9.6) 2) Mould developed on Chiba relief during drying

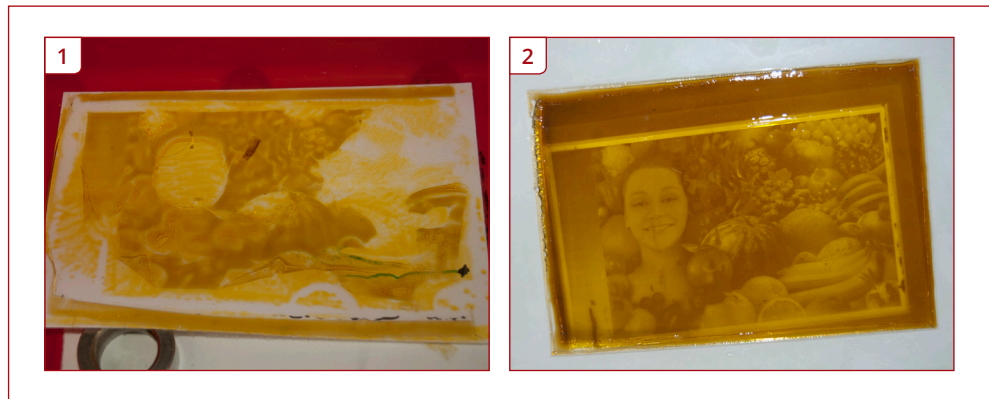

Figure 4.40 Relief damaged during double transfer to additional support (as per carbon method) in development stage. Latent image cannot be washed out due to the dark effect.

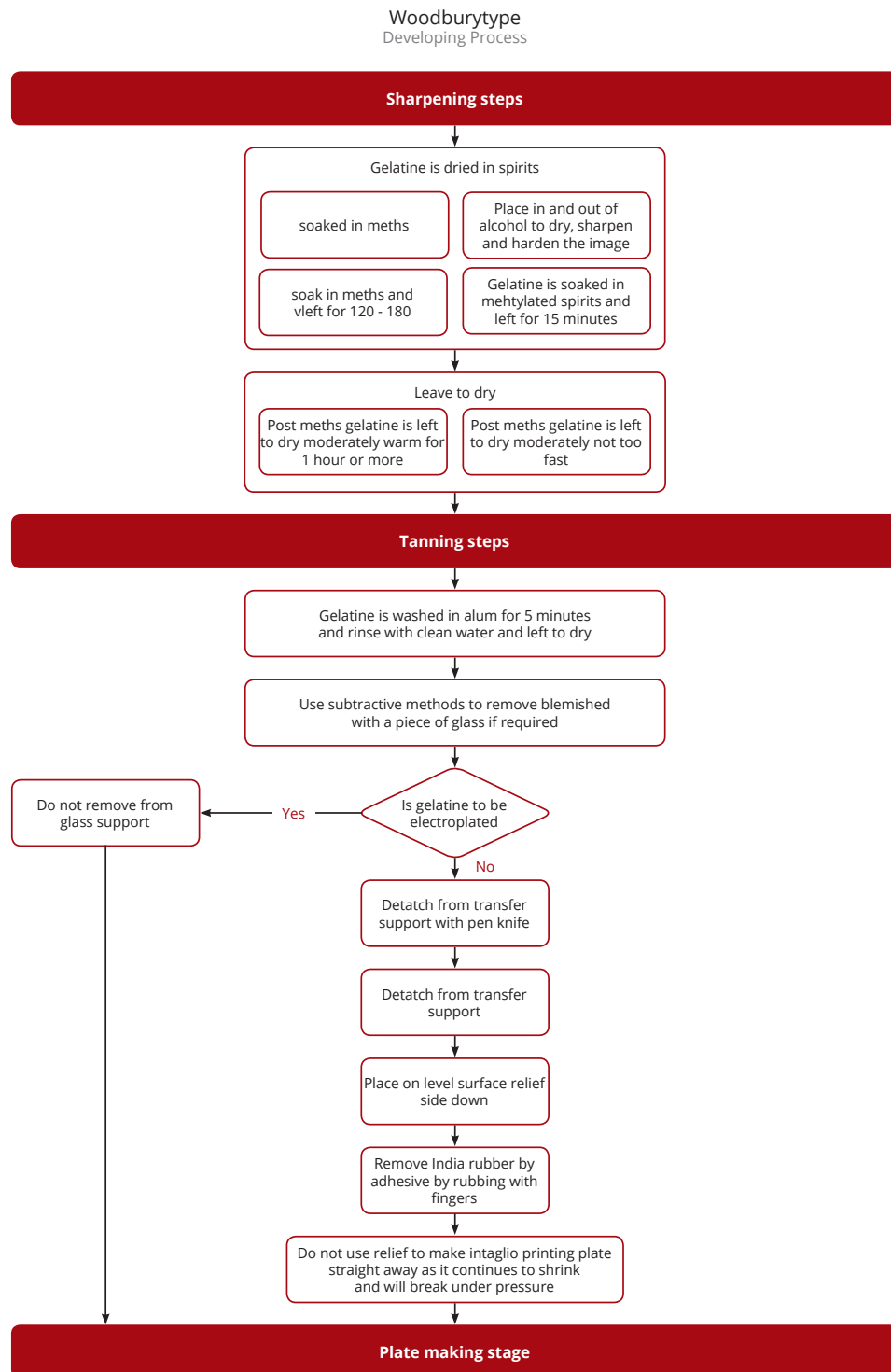

Figure 4.41 Sharpening

4.9 Plate Manufacturing

There are three methods that allow for the manufacturing of the printing plates: electrodeposition (Woodbury, 1865)^[123], casting (Woodbury, 1865)^[124] and impression (Photographic Journal, 1865)^[125]. The plates were either made by the printer himself or by a third party manufacturer. The photo-relief is the matrix from which all printing plates will be made.

The most common method was by impression, the initial description was electrodeposition method and was described by Woodbury in his original patent 2334 September 23 1864. (Woodbury 1864)^[126].

4.9.1 Electrodeposition

Electrodeposition is the term given to the process of depositing metals by electrolysis (Curtis, 2004)^[127]. The process can be achieved in three ways, not all of them are suitable.

4.9.2 Electroplating:

A thin deposit of between 5 – 25 microns of a more noble (less reactive) metal over a less noble or non-metallic surface where it is permanently attached. This is usually done for protective or decorative purposes.^[128]

4.9.3 Heavy deposition:

A layer of substantial thickness is deposited often selectively over an object where it is permanently attached. This is usually done for reparative or restorative purposes. Excess deposition can be machined back to the original specification.^[129]

4.9.4 Electroforming:

A layer of metal thick enough to be self-supporting is deposited over a mandrel or a mould, which is normally removed to leave an object made entirely by the process of electrodeposition.^[130] Electroforming is the most suitable method to create the electrodeposition.

¹²³ Woodbury, W.B. (12/05/1865) New Patent: Complete Specification of Patent Obtained by Walter Bently Woodbury, Manchester, filed 23rd March, 1865. *British Journal of Photography*. XII

¹²⁴ Woodbury, W.B. (18/08/1865) The New Photo-Relief Printing Process In Semi-Transparent Ink. *Photographic News*. IX

¹²⁵ Unknown (15/12/1865) Mr. Woodbury's Photo-Relievo Process. *The Photographic Journal*.

¹²⁶ Woodbury, W.B. (1864) An Improved Method of Producing Or Obtaining by the Aid of Photography Surfaces in 'Relievo' and 'Intaglio' upon Aluminous, Vitreous, Metallic, Or Other Suitable Materials Anon.

¹²⁷ Curtis, L. (2004) *Electroforming*. 1st ed. London: A&C Black Publishers Ltd.

¹²⁸ CURTIS, L., 2004. *Electroforming*. 1 edn. London: A&C Black Publishers Ltd.

¹²⁹ Ibid

¹³⁰ Ibid

4.9.5 Making the non-conductive photo-relief conductive

The photo-relief is the matrix that will be electroformed. Gelatine is not conductive and as such it will not take a metallic deposition. It is also organic and will dissolve in the electrolyte bath of Copper Sulphate CuSO_4 . Natural rubber from the adhesive used to fix the relief to the support contains sulphur compounds that will leech out and contaminate the electrolyte solution.

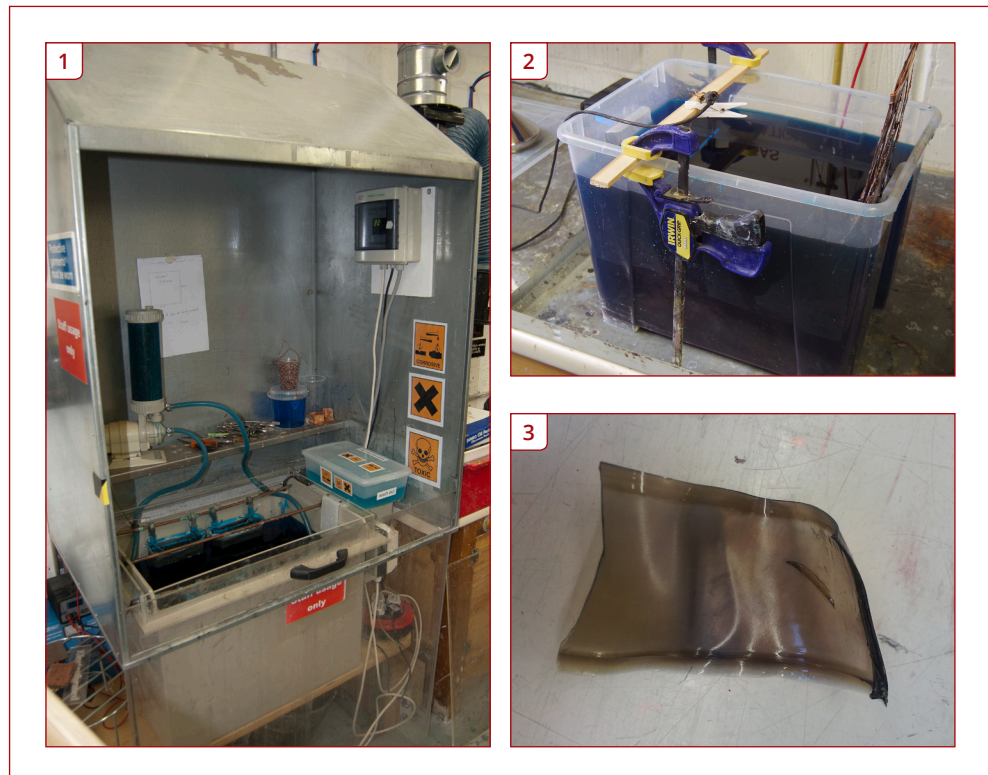

Figure 4.42 1) Electrodeposition tank 2) Isolated electrodepositon tank to prevent contamination in main electrolyte solution during gelatine testing 3) Gelatine treated with chrom alum and soaked in electrolyte solution for 12 hours.

Porous surfaces must be sealed and then coated with a metallic layer (Curtis, 2004)^[131]. No mention of a sealing solution was found in historical references but a cellulose lacquer can be used with contemporary electroforming baths (Curtis, 2004)^[132]. The gelatine relief was bathed in alum rendering it hydrophilic while also tanning it. Details of the electroforming method used in this study follow Curtis' method.(2004)^[133]

¹³¹ Curtis, L. (2004) *Electroforming*. 1st ed. London: A&C Black Publishers Ltd.

¹³² Ibid

¹³³ Ibid

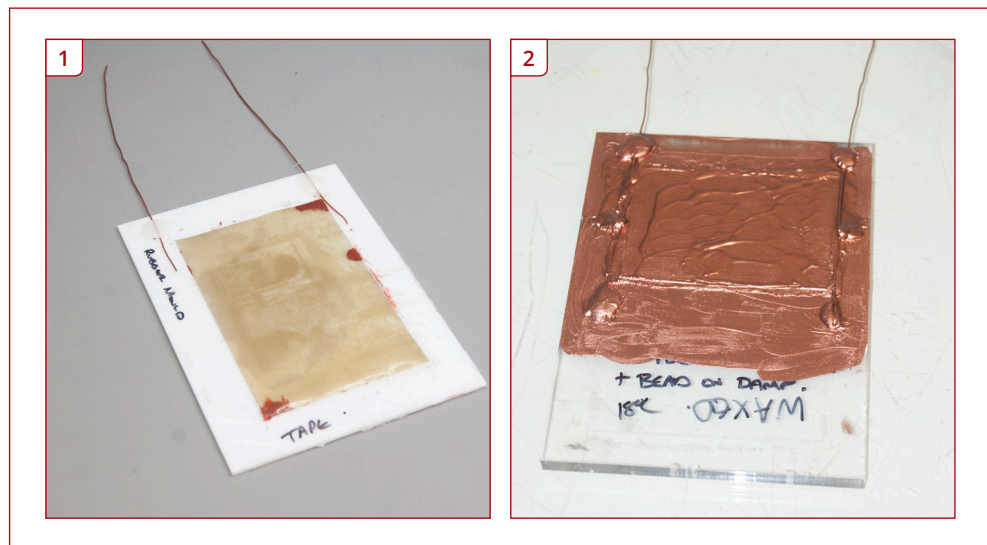

Figure 4.43 1) Gelatine relief adhered to rigid support and electrodes attached
2) Conductive paint applied to relief

If a talc support is used the talc is adhered to the glass normally with Canada balsam thinned with turpentine (British Journal of Photography)^[134]. It is placed under pressure with a piece of blotting paper over the matrix to protect it from the excess balsam coming in contact with it. Copper wires are attached to the support or run across the talc support (if used) attaching it to a glass plate (Woodbury, 1865)^[135].

Various methods were used to make the gelatine conductive. It could be done by either of two methods: by brush applying a metallic powder such as plumbago (graphite) (Woodbury, 1865)^[136], bronze powder (Woodbury, 1865)^[137], or copper, or by coating with ammonia of silver salts (Woodbury, 1865)^[138] (also known as ammoniacal silver nitrate or silver salts) (Woodbury, 1865)^[139] which would evaporate to leave behind a metallic residue.

¹³⁴ Unknown (25/08/1865) Printing Photographs from Metal Plates. British Journal of Photography. XII

¹³⁵ Woodbury, W. B. (12/05/1865) New Patent: Complete Specification of Patent Obtained by Walter Bently Woodbury, Manchester, filed 23rd March, 1865. British Journal of Photography. XII

¹³⁶ Woodbury, W.B. (18/08/1865) The New Photo-Relief Printing Process In Semi-Transparent Ink. Photographic News. IX

¹³⁷ Woodbury, W. B. (12/05/1865) New Patent: Complete Specification of Patent Obtained by Walter Bently Woodbury, Manchester, filed 23rd March, 1865. British Journal of Photography. XII

¹³⁸ Woodbury, W.B. (18/08/1865) The New Photo-Relief Printing Process In Semi-Transparent Ink. Photographic News. IX

¹³⁹ Woodbury, W. B. (12/05/1865) New Patent: Complete Specification of Patent Obtained by Walter Bently Woodbury, Manchester, filed 23rd March, 1865. British Journal of Photography. XII

Ammonical silver nitrate is still used today commercially (Curtis, 2004)^[140], silver nitrate is dissolved and ammonium hydroxide is slowly added. When ammonical silver nitrate is evaporated to a dry state the residue that is left behind is explosive.

Electrodes are attached to the relief and placed into the acid bath and connected. The electrodeposition takes from 30 minutes to 5 or 6 days (British Journal of Photography, 1865)^[141]s. Curtis has a contemporary deposition chart that illustrates the deposition over time in relation to the amps per square decimetre based on 100% efficiency.^[142]

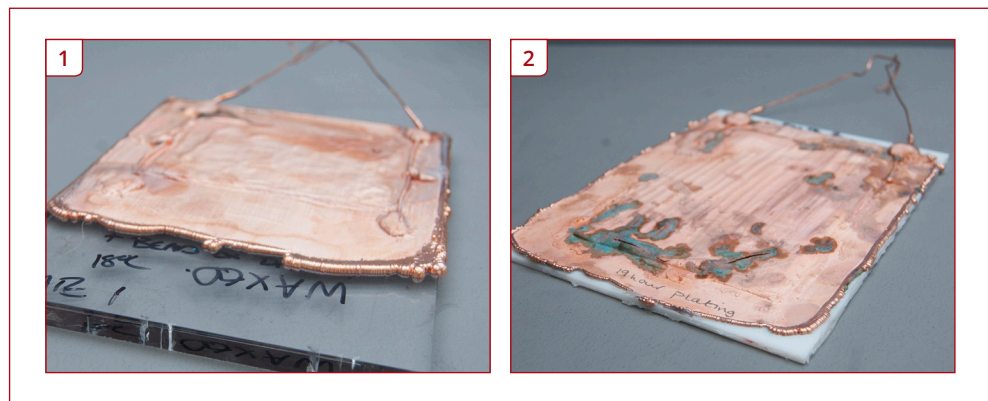

Figure 4.44 1) Deposition on relief after 19 hours
2) Deposition on relief after 19 hours however deposition is damaged

The conductivity of the deposition metal, electrical current, purity of electrolyte and conductive treatment on the relief, all effect the time needed to get a suitable deposition. The historical depositions state the electrotype to be 1/16" (1.59mm) or greater (Woodbury, 1865)^[143] where the exact deposition required depends on the relief height(Woodbury, 1865)^[144]. Described as requiring a considerable thickness (British Journal of Photography)^[145] images consisting of mostly highlights required less of a deposit (Woodbury, 1865)^[146]. Using Curtis' chart it is possible to estimate the historical settings used to get a copper deposit of 1.6mm in approximately 6 days with the current density set at 5.0 amps per square decimetre. The fastest deposition on the

¹⁴⁰ Curtis, L. (2004) *Electroforming*. 1st ed. London: A&C Black Publishers Ltd.

¹⁴¹ Unknown (25/08/1865) *Printing Photographs from Metal Plates*. *British Journal of Photography*. XII

¹⁴² CURTIS, L., 2004. *Electroforming*. 1 edn. London: A&C Black Publishers Ltd.

¹⁴³ Woodbury, W. B. (12/05/1865) *New Patent: Complete Specification of Patent Obtained by Walter Bently* Woodbury, Manchester, filed 23rd March, 1865. *British Journal of Photography*. XII

¹⁴⁴ Woodbury, W.B. (18/08/1865) *The New Photo-Relief Printing Process In Semi-Transparent Ink*. *Photographic News*. IX

¹⁴⁵ Unknown (25/08/1865) *Printing Photographs from Metal Plates*. *British Journal of Photography*. XII

¹⁴⁶ Woodbury, W.B. (18/08/1865) *The New Photo-Relief Printing Process In Semi-Transparent Ink*. *Photographic News*. IX

chart was 1.6mm in 22.5 hours, nowhere near the 30 minute historical account.

4.9.6 Separating the electrodeposited plate and backing it

The electrotype was then backed. This involved pouring molten sulphur which could be melted to a thick consistency and poured onto the electroform.

4.9.7 Casting Plates

A glass plate would then be quickly pressed into the sulphur and held in place until it set. Once set, the plate would be pulled back taking with it the electroform removing it from the gelatine relief and exposing the face of the electroformed printing plate. Alternatively it could be fixed with plaster and removed, once set, in a similar manner. The printing plate could then proceed to the printing stage of the process.

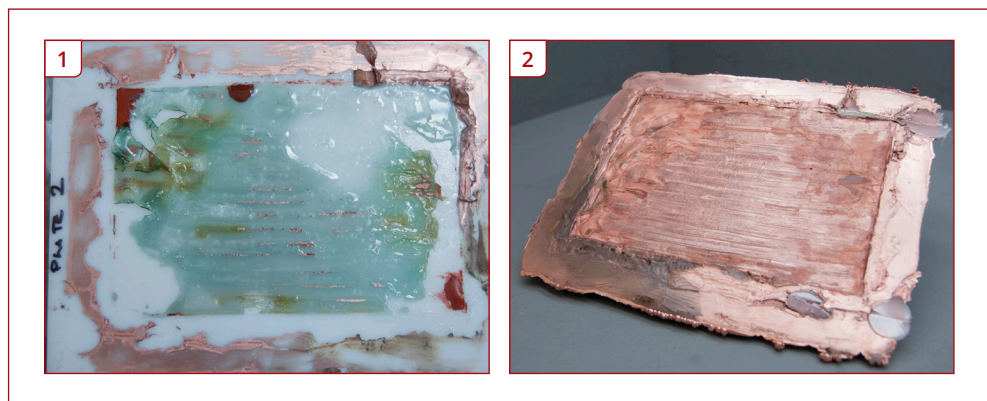

Figure 4.45 1) Gelatine matrix destroyed by electrodeposition
2) Electroformed plate once removed from support



Figure 4.46 Partial detail of relief did build an electrodeposit, however relief was destroyed before electroforming process completed

Woodburytype
Plate Manufacture - part one

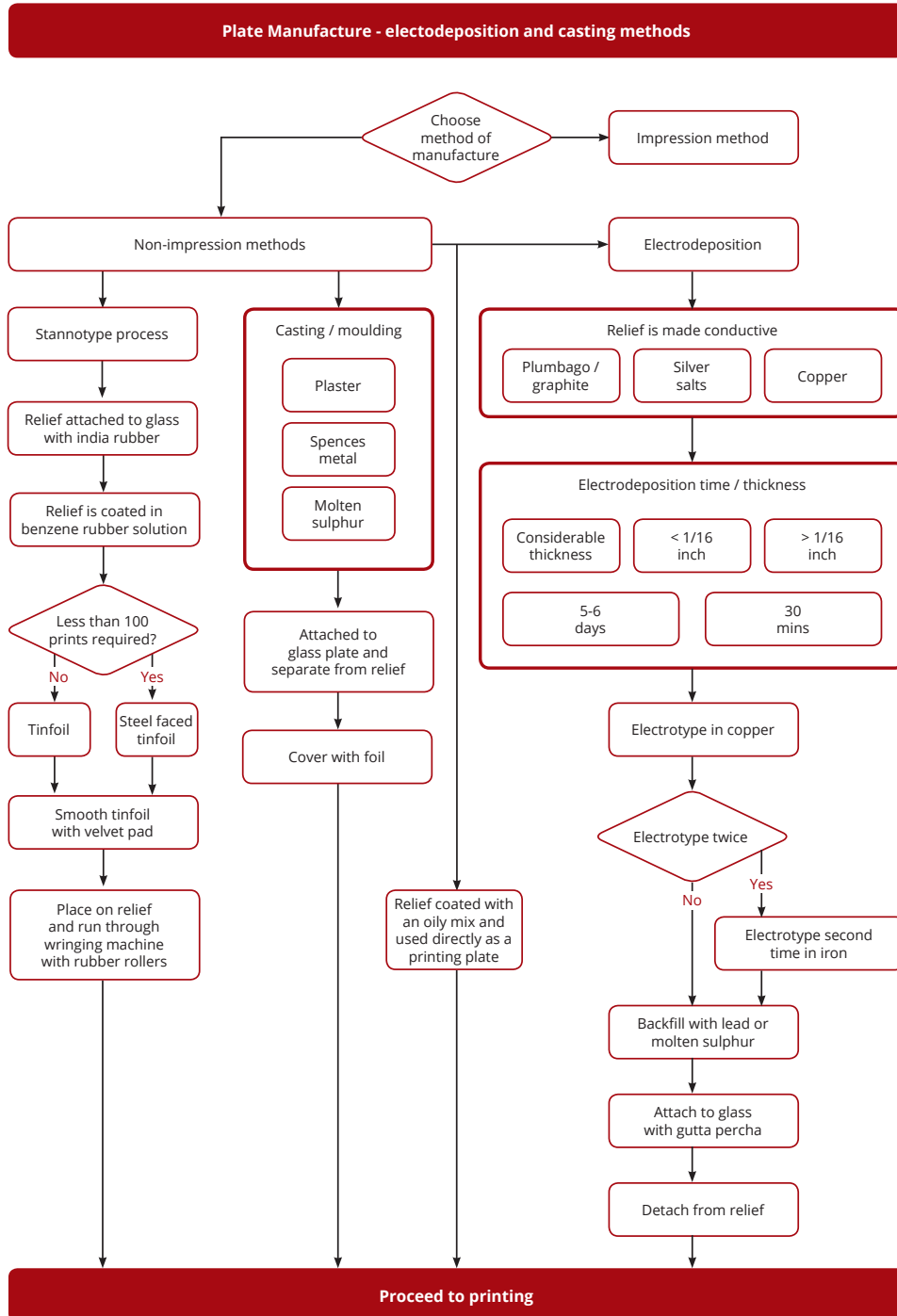

Figure 4.48 Plate manufacture - electrodeposition and casting

4.9.8 Plates manufactured by impression

The most commonly described method in the traditional process was by impressing the matrix into soft type metal, typically lead or a lead alloy (The Photographic Journal, 1865)^[147]. Initially this was achieved by passing the gelatine relief and a lead sheet through a rotary press or similar roller press. The impression was taken by applying screw or a rolling pressure (Photographic News, 1865)^[148].

Mr. WHARTON SIMPSON said that Mr. Woodbury tried in the first instance electrotyped copper plates, but abandoned them in favour of lead and antimony. When lead plates got damaged or worn out, they could be melted down and used again.^[149]

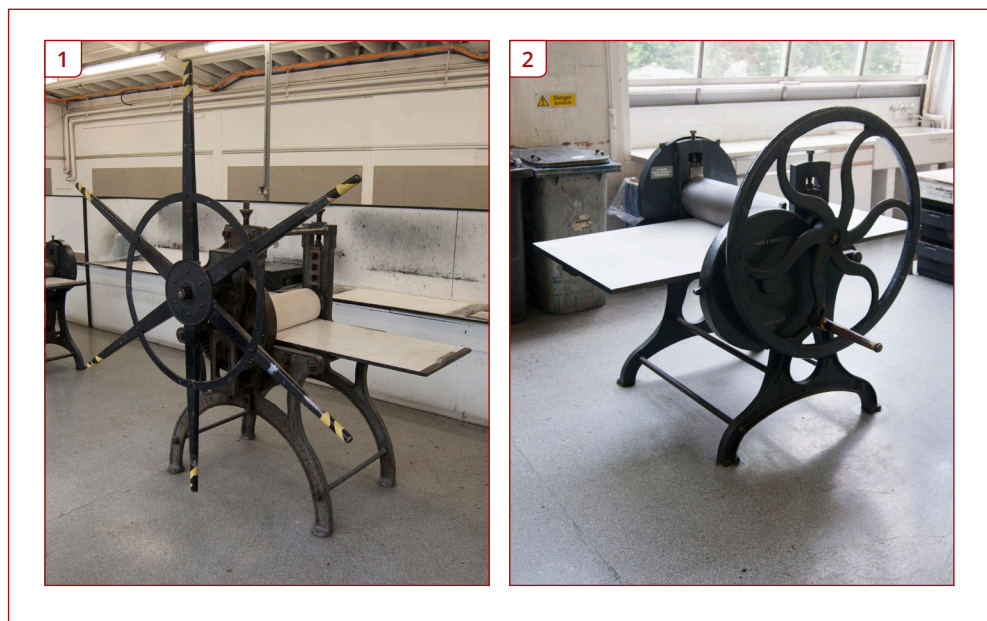

Figure 4.47 1-2) Presses available at the Centre for Fine Print Research

This method was superseded where the impression was made with even hydraulic pressure.

4.9.9 Hydraulic presses

The initial investment of equipment to create Woodburytypes was very considerable. A large hydraulic press capable of exerting 500 tonnes of force (Waterlow, 1888)^[150]

¹⁴⁷ Unknown (15/12/1865) Mr. Woodbury's Photo-Relievo Process. The Photographic Journal.

¹⁴⁸ Woodbury, W.B. (18/08/1865) The New Photo-Relief Printing Process In Semi-Transparent Ink. Photographic News. IX

¹⁴⁹ Woodbury, W.B. (16/03/1869) Description of the Woodburytype, or Photo-Relief Process. The Photographic Journal.

¹⁵⁰ Waterlow, G.S. (30/03/1888) Modern Photographic Engraving and Printing (Part 2). Photographic News. XXXII

was required to create the lead plates, and in 1870 this cost £156 (Hannavy, 2008)^[151] plus the cost of a licence to produce the prints. Amateur photographers and small print shops simply could not afford the initial investment. In 2015's economy, this was roughly equivalent to £13,460 (Officer, Williamson, 2016)^[152].

In 1865 hydraulic presses were being described that used a screw mechanism to produce intaglio plates. Suitable presses for making whole plate intaglios was said to cost £50 in 1884 and that the Tangye Bros (Birmingham) produced these “suitable” presses from their premises in Queen Victoria Street, London (Photographic News, 1884)^[153]. In 2015's economy, this was roughly equivalent to £4,700 (Officer, Williamson, 2016)^[154].

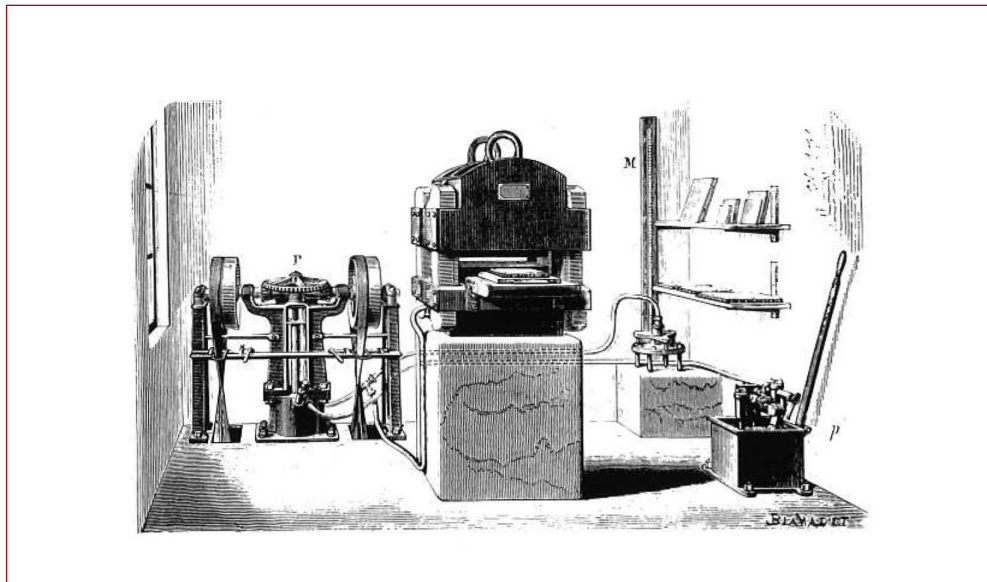

Figure 4.49 Illustration of hydraulic press and pump used to make Woodburytype printing plates

4.9.10 Cost of Investment

4.9.11 The Tangye Bros 18” Hydraulic Ram Press

Previously all of these presses had been thought to have been scrapped in 1928. This date was still being circulated in contemporary literature until the early 2000's. This

¹⁵¹ Hannavy, J., ed. (2008) *Encyclopedia of Nineteenth-Century Photography*. 1st ed. USA: Routledge.

¹⁵² OFFICER, L.H. and WILLIAMSON, S.H. (2016) *Measuring Worth Purchasing. Power of Money in the United States from 1774 to 2010*. Available from: <https://www.measuringworth.com/ukcompare/relativevalue.php> [Accessed 03/06/2016].

¹⁵³ Unknown (04/04/1884) *The Woodbury Process: Fourth Article*. *Photographic News*. XXVIII

¹⁵⁴ OFFICER, L.H. and WILLIAMSON, S.H. (2016) *Measuring Worth Purchasing. Power of Money in the United States from 1774 to 2010*. Available from: <https://www.measuringworth.com/ukcompare/relativevalue.php> [Accessed 03/06/2016].

is because the authors reference Josef Maria Eder and what he recorded in his book "History of Photography", (Eder)^[155] (trans E Epsteam, 1978)^[156]. In it he states that he had purchased the last Woodburytype equipment that was at Braun of Dornach, installed it at the Graphische Lehr und Versuchsanstalt in Vienna (Graphic Teaching and Research Institute), and then later scrapped it. Unknown to Eder there was another press in existence. In 2000 Mats Broberg found the last remaining Tangye Bros Woodburytype hydraulic press in Wrought Artworks' workshop, Redfern, outside Sydney, Australia. The Tangye Bros 18" Hydraulic Ram Press, built and installed in 1888 is the last surviving hydraulic press that was designed and patented specifically for Woodburytypes. The press is now part of the Eveleigh Railway Workshops Machinery Collection. While it is complete and in sound condition it has been decommissioned and now listed under the Heritage Act.^[157]

A description of the press is given by Eveleigh in its asset register and it is as follows:

"This small press of the Patent Woodury type (sic) exhibits all of the hallmarks of the extremely simple and very effective machinery of the nineteenth century that was used by the railways up until the late twentieth century. The ram press consists of a massive cast-iron footing from which there are four threaded shafts extending vertically for about 1.8 metres. A fixed head is attached to these shafts by massive nuts, one above and one below the head. The head can be raised or lowered to any height and fastened into place by the dexterous use of a massive spanner. Items to be pressed are placed on the platen and hydraulic pressure is introduced through a simple lever. The platen then raises and presses the item against the head. It is possible to use dies above and below the piece being worked."

¹⁵⁵ Eder, J.M. (1932) Geschichte Der Photographie. 4th ed. Germany:

¹⁵⁶ Eder, J.M. (1978) History of Photography. 4th ed. USA: Dover.

¹⁵⁷ s.170 NSW State agency heritage register: Australian Technology Park Heritage Register Listing date: 30 Jun 08.

Reference Number: 4745049

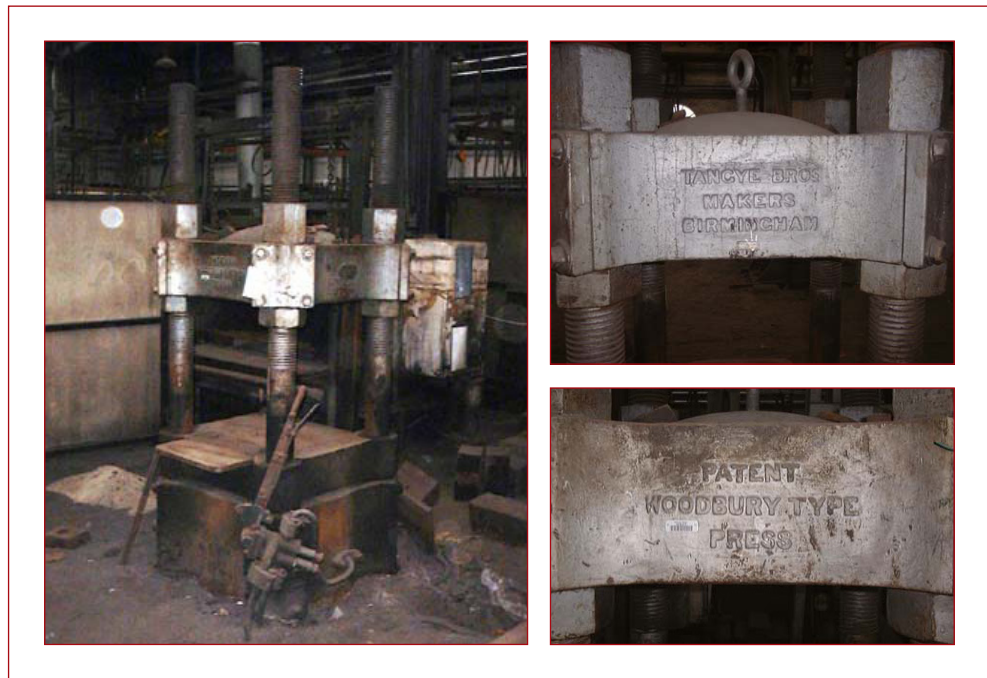

Figure 4.50 Last remaining Woodburytype press, photo courtesy of Mats Broberg

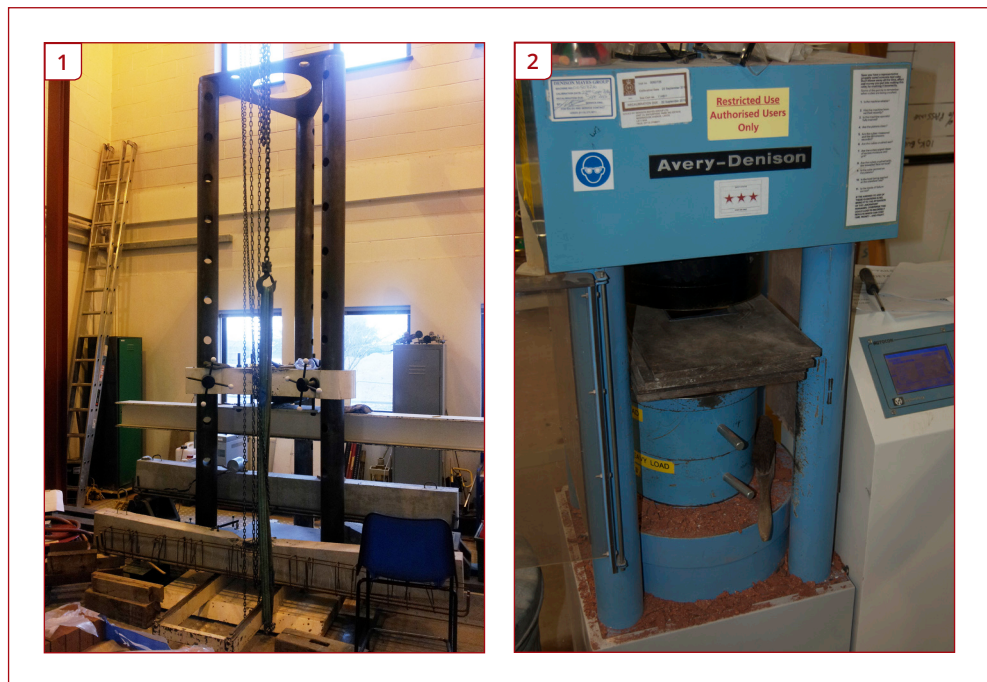

Figure 4.51 1 - 2 200kN hydraulic presses at UWE Bristol used to stress test concrete

4.9.12 Intaglio plate alloys

The lead alloy of the traditional plates were unknown for most instances, but some recipes are available. It is to be noted that depending on the alloy used the pressure would have had to either be increased or decreased. The exact metallurgy used varied, lead was the core metal with it often being called soft metal, type metal, lead and antimony consisting of a mix of cadmium, tin, lead and bismuth. The metallurgy of the plates depended on number of prints in edition (Woodbury, 1865)^[158] (See Appendix 4 for alloy recipe).

A sheet of lead is planed (Woodbury, 1865)^[159] and rolled (Photographic News, 1865)^[160] and polished (Woodbury, 1865)^[161] prior to use to ensure that the surface is flat and free from defects. It is roughly trimmed to size (Woodbury, 1865)^[162] and it was noted that the metal was between 1/8 inch thick (Woodbury, 1865)^[163] and 3/4" thick (19mm) (Sutton, 1870)^[164] before pressure was applied to make the plate.

In this study lead sheeting was commercially sourced and manufactured to BS EN: 12588:2006^[165] which stipulates that:

"The surface of the lead sheet shall be smooth, free from holes, cracks dross inclusions and laminations."

The lead used was given a thickness of Code 4. Code four is no longer the standard coding system but it relates to BS EN 12588:1999^[166] & BS EN 1178:1982^[167], the colour code of which is blue. Under the most recent standard Lead in colour coding blue is

Blue 1.75mm – 1.80mm (BS EN12588:2006) with a tolerance of ±5%

¹⁵⁸ Woodbury, W.B. (18/08/1865) The New Photo-Relief Printing Process In Semi-Transparent Ink. Photographic News. IX

¹⁵⁹ Woodbury, W.B. (18/08/1865) The New Photo-Relief Printing Process In Semi-Transparent Ink. Photographic News. IX

¹⁶⁰ Waterlow, G.S. (30/03/1888) Modern Photographic Engraving and Printing (Part 2). Photographic News. XXXII

¹⁶¹ Woodbury, W.B. (18/08/1865) The New Photo-Relief Printing Process In Semi-Transparent Ink. Photographic News. IX

¹⁶² Woodbury, W.B. (18/08/1865) The New Photo-Relief Printing Process In Semi-Transparent Ink. Photographic News. IX

¹⁶³ Woodbury, W.B. (18/08/1865) The New Photo-Relief Printing Process In Semi-Transparent Ink. Photographic News. IX

¹⁶⁴ Sutton, T. (01/03/1870) A Week at the Woodbury - Printing Establishment of MM. Goupil at Ansieres, near Paris. The Photographic Art Journal.

¹⁶⁵ Lead and Lead Alloys — Rolled Lead Sheet for Building Purposes BS EN 12588:2006. (2006) UK:

¹⁶⁶ Lead and Lead Alloys - Rolled Lead Sheet for Building Purposes BS EN 12588:1999. (1999) UK:

¹⁶⁷ British Standard Specification for Milled Lead Sheet for Building Purposes BS 1178:1982. (1982) UK:

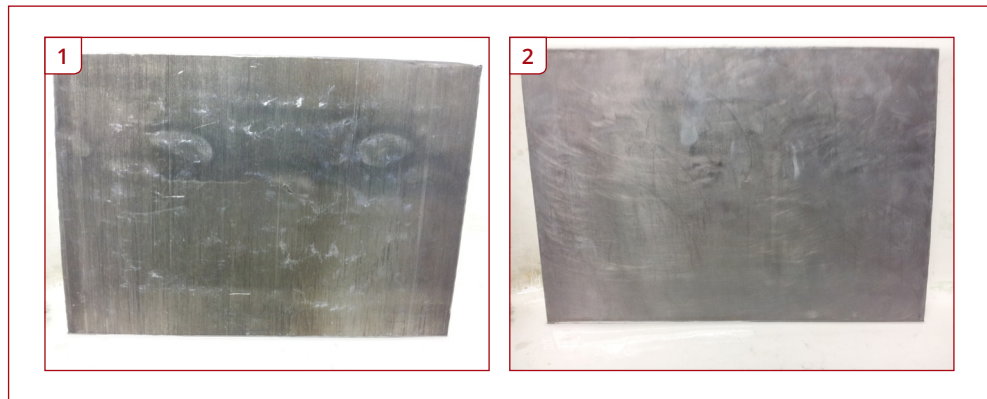

Figure 4.52 Lead blank before and after wet polishing to remove surface blemishes

For this study the lead was cut to size and any sharp edges filed back. The lead was passed through a roller to flatten it. It was polished with wet emery abrasives. The polishing started at a coarse grit of 400 and gradually was increased in 200 grit increments to 1200 grit until all of the blemishes were removed.

4.9.13 Platens

Two steel or cast iron plates are required. The hardest steel / tool steel is used (Waterlow, 1888)^[168]. The cast metal plates need to be larger than the soft type metal sheet. The cast metal plates varied in thickness from ½ inch to 2 ½ inches thick (Woodbury, 1865)^[169]. The metal plates are tooled and planed (Woodbury, 1865)^[170] so that they are level (Tissandier, 1876)^[171] after which they are polished smooth with emery (British and Colonial Printer and Stationer, 1893)^[172].

4.9.14 Positioning the relief on the platen

The matrix is placed onto the metal platen collodion side down and the soft metal placed on top of the relief (Woodbury, 1865)^[173].

168 Waterlow, G.S. (30/03/1888) Modern Photographic Engraving and Printing (Part 2). *Photographic News*. XXXII

169 Woodbury, W. B. (18/08/1865) The New Photo-Relief Printing Process In Semi-Transparent Ink. *Photographic News*. IX

170 Woodbury, W.B. (18/08/1865) The New Photo-Relief Printing Process In Semi-Transparent Ink. *Photographic News*. IX

171 Tissandier, G. (01/01/1876) A History and Handbook of Photography (Part II, Chapter II). *A History and Handbook of Photography*.

172 Unknown (13/04/1893) Extract - Messrs. Waterlow & Sons' Photo-Mechanical Printing Works. *British & Colonial Printer & Stationer*. XXXI

173 Woodbury, W.B. (18/08/1865) The New Photo-Relief Printing Process In Semi-Transparent Ink. *Photographic News*. IX

4.9.15 Boundary Frames (optional)

Some descriptions of the process included the use of a boundary frame made from steel. It was used to prevent the soft type metal from spreading when under pressure. It was described as being a mitred frame $\frac{3}{8}$ inch high x $\frac{1}{2}$ inch wide and bolted to a steel platen with $1\frac{1}{4}$ " bolts (Photographic News, 1884)^[174]. The bottom inside edge of the frame was bevelled away and the overall size of the frame was slightly smaller than the lead plates that were going to be made into the intaglio printing plate. When in use the lead plate sat across the aperture of frame recess (Woodbury E, 1896)^[175].

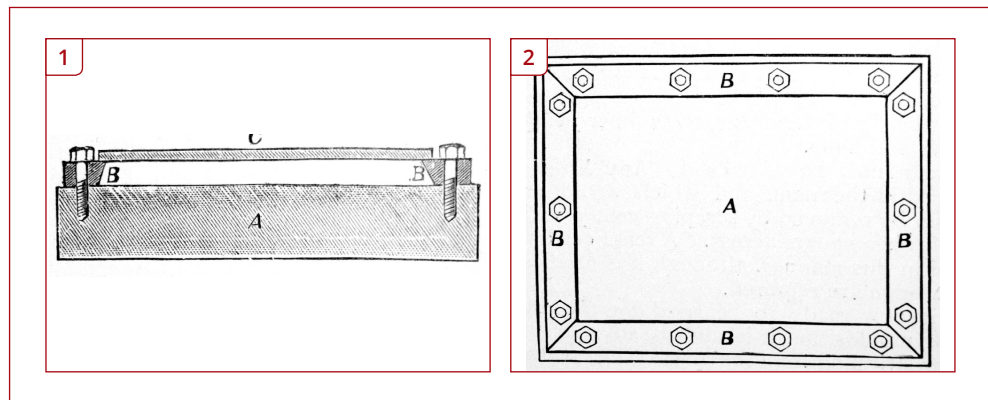

Figure 4.53 Boundary frames used for intaglio plate making

4.9.16 Positioning the relief into the boundary frame (optional, hydraulic impression only)

The relief is positioned flat side down onto the frame that is bolted onto the steel platen. The soft type metal plate is placed across the frame.

4.9.17 Top platen

The second metal plate is placed upon top so that the relief and soft type metal plate is sandwiched between them. The soft metal plate is against the polished platen. Lead is placed against polished platen (Woodbury, 1865)^[176]. Millwood boards could be placed onto of the metal boundary frame instead (Photographic News, 1884)^[177]. The sandwich of materials is placed into the press and pressure is applied.

¹⁷⁴ Woodbury, W.E. (1896) The Encyclopaedic Dictionary of Photography. The Scovill & Adams Company of New York.

¹⁷⁵ Unknown (04/04/1884) The Woodbury Process: Fourth Article. Photographic News. XXVIII

¹⁷⁶ Woodbury, W.B. (18/08/1865) The New Photo-Relief Printing Process In Semi-Transparent Ink. Photographic News. IX

¹⁷⁷ Woodbury, W.E. (1896) The Encyclopaedic Dictionary of Photography. The Scovill & Adams Company of New York.

4.9.18 Removal from boundary frame (optional, hydraulic only)

The boundary frame had to be unbolted for the soft metal intaglio plate to be removed.

4.9.19 Best results and relief depth

Best results were obtained when the soft type metal plate was impressed into the relief with the flat side against the metal platen. The final metal intaglio plate has depressions as thin as card and described as less pronounced than those produced by electrodeposition.

4.9.20 Hydraulic pressure

In the literature a wide range of details was recorded for the amount of force and pressure that was required to make the plates through hydraulic pressure. All of the records of pressure and force needed were consistently large. The details suggest that a press capable of several hundred tonnes of force is required to produce up to tens of tonnes of pressure.

The formula to calculate pressure is as follows

$$\text{Pressure} = \text{Force} \div \text{Area} \quad | \quad \text{Force} = \text{Pressure} \times \text{Area}$$

The information in relation to the force needed to produce a printing plate is confusing. The accounts appear to use the terms force and pressure interchangeably. I believe this to be the case because the maximum and minimum force, and the pressure recorded varies too drastically for both sets of figures.

In this example, one report states that 200 tonnes per square inch was capable of producing a plate of $8\frac{1}{2} \times 6\frac{1}{2}$ inches. That would require a press capable of 10,625 tonnes of force. ($200 \text{ P} \times (8\frac{1}{2} \times 6\frac{1}{2}) \text{ A} = 10625 \text{ F}$)

I believe that where low numbers (single and tens of units) were used the authors intention is to report the pressure per square inch, and where large numbers (hundreds of units) were recorded the intention was to report the hydraulic force that the press was capable of producing. When this is taken into account, and if I reassess the example using this logic, then a hydraulic press capable of 200 tonnes of force was needed to exert almost 4 tonnes per square inch, which appears to be a more reasonable set of figures.

$$(200 \text{ F} \div (8\frac{1}{2} \times 6\frac{1}{2}) \text{ A} = 3.62 \text{ P})$$

The research believes that based on the varying accounts the pressure required was approximately 2 – 5 tonnes psi and the hydraulic press had to be capable of ≥ 200 tonnes of force, but again this could fluctuate depending on the lead alloy used.

Two things were noted that would affect the force needed to produce the intaglio printing plate. Firstly the metallurgy used to make the plates varied, the one consistency was that it was comprised of lead or a lead alloy. Secondly as the force the press is capable of is a fixed value the pressure available is directly proportional to the area of the printing plate. The larger the area of the matrix the available pressure becomes lower. By lowering the area of the relief the pressure produced by the hydraulic press can be increased allowing for presses that produce less force to become useable.

A hydraulic press capable of achieving a suitably high force was one of the main obstacles that hindered Woodburytype printing.

Based on the tests for this study to create an adequate impression into a blank lead plate a gelatine relief of 6x4 inches was required to have the surface area that would provide 4 tonnes per square inch for every 200 kilonewtons of force. The area of the relief could be made smaller should the depth of the impression need to be increased. No boundary frames were used in these tests. Steel plates that were planed and ½ inch thick were used as platens to sandwich the lead and relief during impression. The lead plates were cut to size to suit the gelatine relief. After applying pressure the edges of the lead had slightly spread.

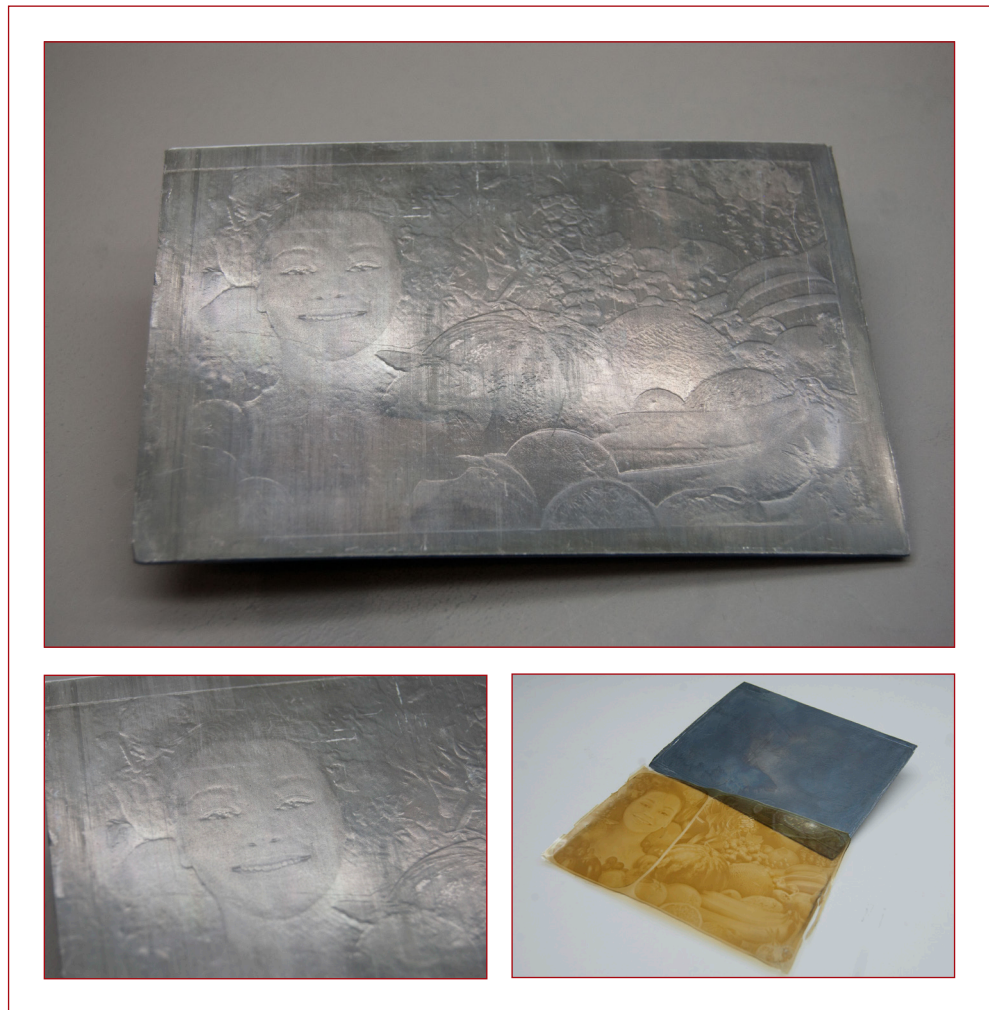

Figure 4.54 Lead Woodburytype plate, detail of plate, and tissue with plate

4.9.21 Lead printing plates

4.9.22 Intaglios per relief

Early claims from Woodbury state that any number of intaglios can be produced from the matrix,^{(Woodbury, 1865)^[178]} however as the process developed this number fell to between 12 and 20 (Woodbury, 1869)^[179] before the detail within the matrix was crushed and it became unusable. It also stands to reason that intaglio plates made from earlier in the pressings would contain more fine detail than later pressings.

¹⁷⁸ Woodbury, W.B. (18/08/1865) The New Photo-Relief Printing Process In Semi-Transparent Ink. Photographic News. IX

¹⁷⁹ Woodbury, W.B. (16/03/1869) Description of the Woodburytype, or Photo-Relief Process. The Photographic Journal.

Lead without alloy was recommended for print runs up to 30, (Woodbury, 1865)^[180] and that where large volumes are required an alloy that would harden the lead was recommended.^[181] From the recipe that was used in this study, three plates on average was realistically achievable before the gelatine tissue started to crush and detail was being lost.

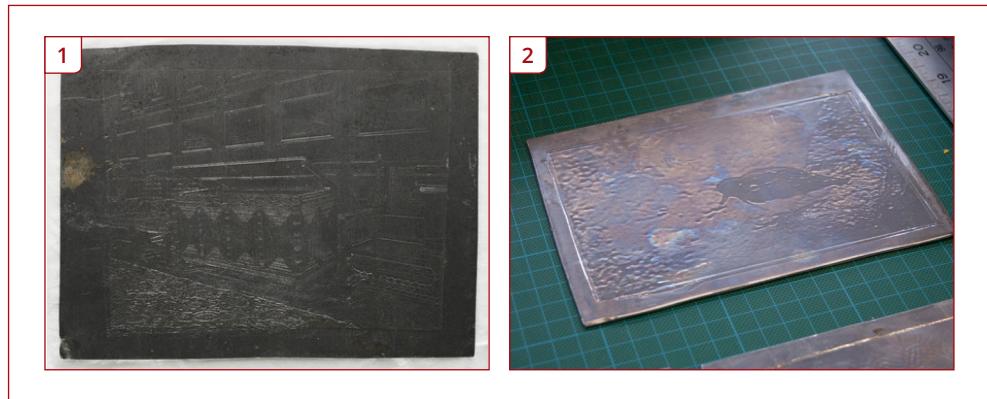

Figure 4.55 1) Original lead Woodburytype plate. Panelled interior, c. 1865. Copyright © Science Museum Library / Science & Society Picture Library
2) Lead plate generated by the research. Notice distortion at the edge of both plates caused by the force impressed onto the lead to make the printing plate

4.9.23 Plate editing (optional)

The soft metal intaglios could be edited slightly by scratching off some minor imperfections with a piece of glass (British & Colonial Printer & Stationer, 1893)^[182], but major alterations were not possible. The plates were trimmed to size with a saw (British & Colonial Printer & Stationer, 1893)^[183] and drainage channels were scratched into the boundaries of the plate (British Journal of Photography, 1884)^[184].

¹⁸⁰ Woodbury, W.B. (18/08/1865) The New Photo-Relief Printing Process In Semi-Transparent Ink. Photographic News. IX

¹⁸¹ WOODBURY, W.B., 18/08/1865. The New Photo-Relief Printing Process In Semi-Transparent Ink. Photographic News, IX

¹⁸² Unknown (13/04/1893) Extract - Messrs. Waterlow & Sons' Photo-Mechanical Printing Works. British & Colonial Printer & Stationer. XXXI

¹⁸³ Unknown (13/04/1893) Extract - Messrs. Waterlow & Sons' Photo-Mechanical Printing Works. British & Colonial Printer & Stationer. XXXI

¹⁸⁴ Unknown (02/05/1884) The Woodbury Process: The Sixth Article. British Journal of Photography. XXVIII

4.9.24 Casting plates

The third method of plate manufacture was to take a cast impression of the matrix. Melted sulphur was traditionally used^[185] however the heat given off from the sulphur would also damage the relief. The relief was attached to a talc support and is rubbed with a little glycerine and the excess rubbed off. Sulphur is heated until it melts to the consistency of treacle, as this leaves the intaglio plate less brittle when cooled. When at this consistency it is then poured onto the relief and a piece of plate glass is pressed quickly down onto the sulphur before it sets. The glass should be used to press the sulphur into all of the recesses of the matrix so that the surface is completely moulded. When cool the sulphur will be attached firmly to the glass and can be separated from the relief and the talc support.

Plaster casts could then be taken from the initial reliefs and casts with lower melting alloys were also used such as Woods metal and Spences metal (Schnauss, 1901)^[186].

During the literature review of this research it was found that the RPS did attempt to take castings using a 2 part curable plastic. They found that due to the exothermic reaction it would warp the gelatine relief. In this research a Shore 60D silicone with low temperature reaction was found to be successful and it did not damage the gelatine relief. This can be seen in Figure 4.58.

¹⁸⁵ WOODBURY, W.B., 18/08/1865. The New Photo-Relief Printing Process In Semi-Transparent Ink. Photographic News, IX

¹⁸⁶ Schnauss, H. (01/01/1901) A New Modification of Woodburytype. Penrose Pictorial Annual.

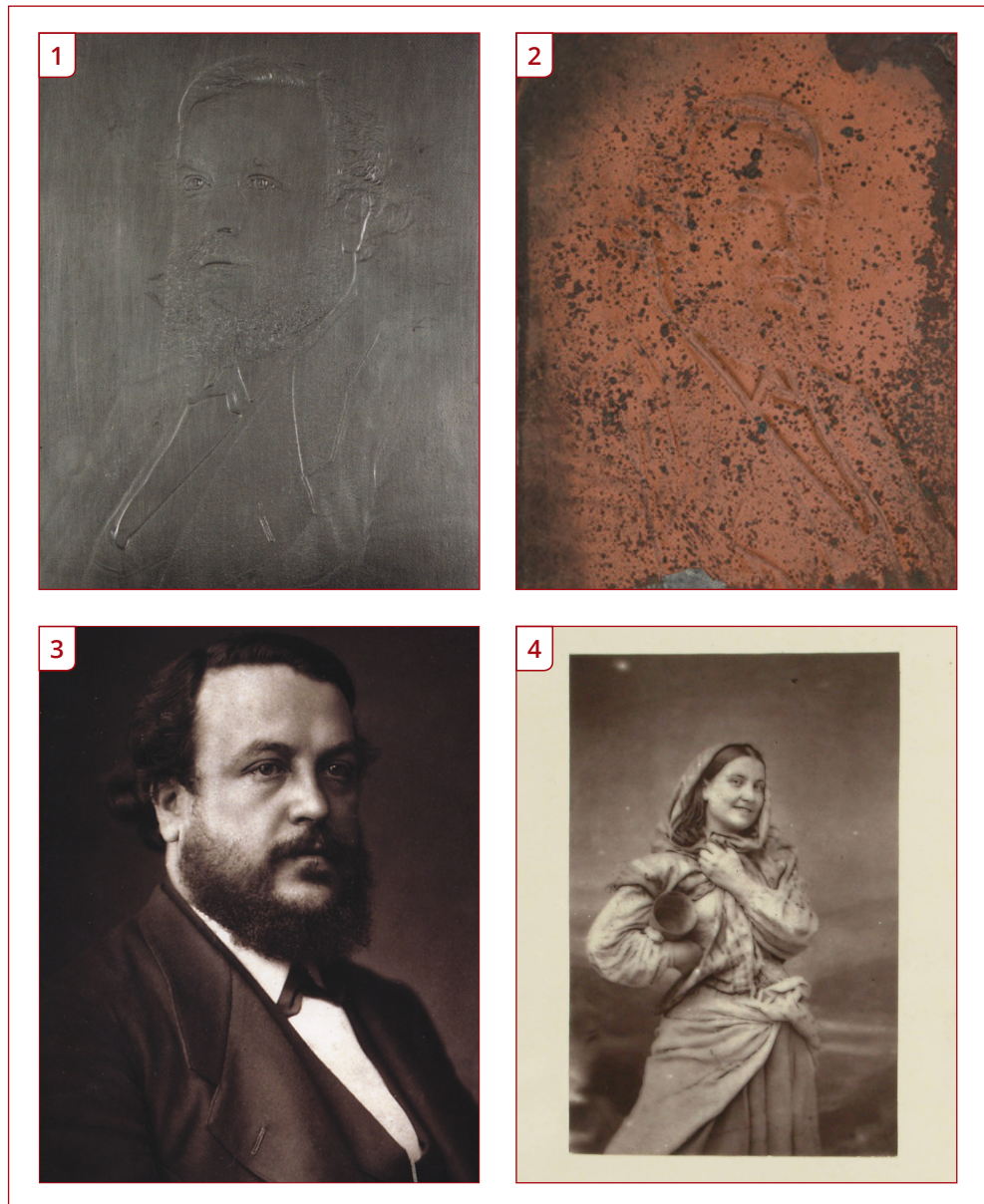

Figure 4.56 1) Stannotype printing plate 2) Rear of stannotype printing plate 3) Print from Stannotype printing plate. Image is Walter Woodbury and is believed to be the only depiction of the inventor to be produced by his own process 4) Mountain Dew Girl - The first Woodburytype print. The entire edition was printed by Woodbury himself. Images 1-4 Copyright © Science Museum Library / Science & Society Picture Library

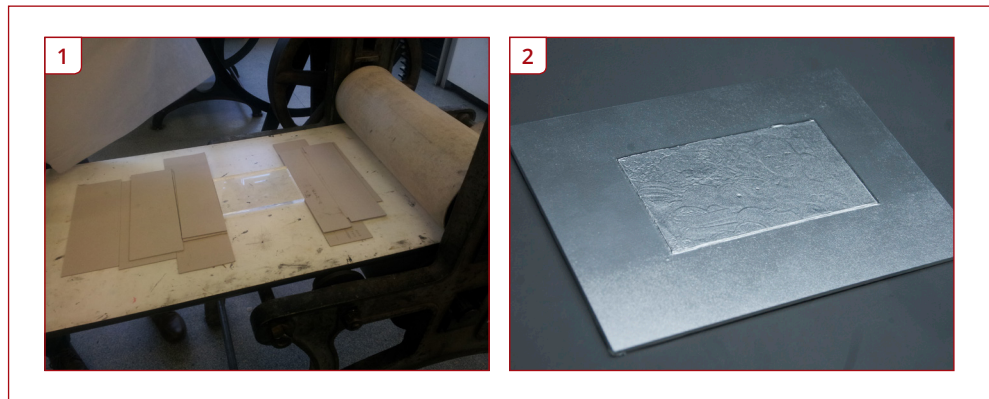

Figure 4.57 Stannotype plate production

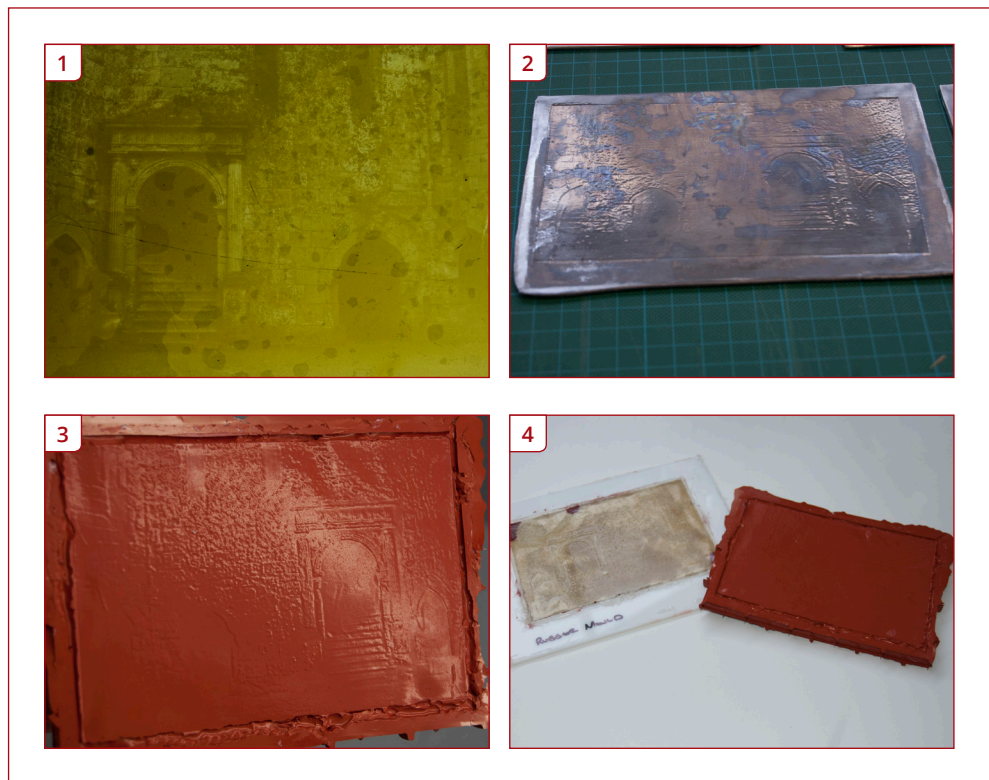

Figure 4.58 1) Gelatine Relief 2) Lead plate created from relief 3) Silicone cast of the same relief 4) Photograph of relief showing that it was not damaged by the silicone casting. The relief was later destroyed in attempts to create a printing plate by electrodeposition.

4.9.25 Stannotype process

The final variation in the process was in 1880. The stannotype process was developed and patented. This variation in the Woodburytype came a little too late in the life of the process and four years before the inventor's death. As other processes were becoming polychromatic Woodbury had only just developed this method which did away for the need of a large hydraulic press. The process is identical to all of the other stages except that the gelatine relief is not stripped from the glass plate after development. Instead it a solution of India rubber in benzole is poured over the surface and a sheet of tinfoil is placed ontop of it. Before applying the tinfoil it is flattened and smoothed with a velvet pad and inspected for any defects. It is then passed through rubber rollers under pressure which forces the tinfoil into the relief. Prints can be taken directly from this metal surface in the same manner as a normal Woodburytype plate. If many prints are required a steel faced tinfoil can be used to make it harder wearing.

Woodburytype
Plate Manufacture - part two

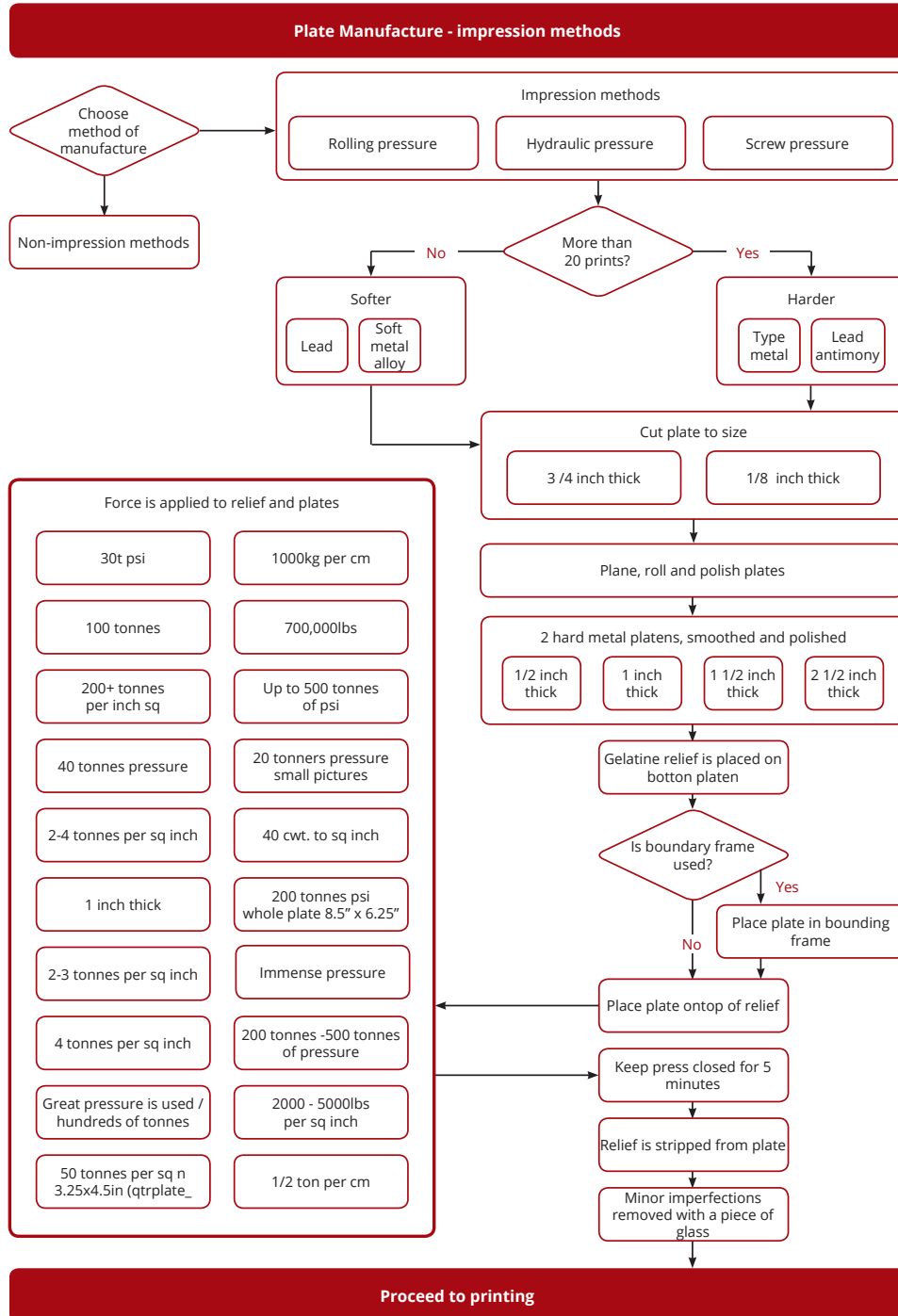

Figure 4.59 Plate manufacture - Impression plates

4.10 Substrates

There are two main substrates used in Woodburytype printing. Glass, or opal glass specifically and paper. Prints on glass could be used as backlit images or as slide transparencies to be projected through a magic lantern projector. Paper had to undergo specific preparatory treatments and not all types of paper could be used.

4.10.1 Paper substrates

The tonality of the Woodburytype is generated through the subtle relief of gelatinous ink. The higher the relief the darker the tone. Therefore paper that is of a fine grain and with a smooth surface is paramount to successful image translation (Woodbury, 1865)^[187]. The surface texture from fibrous paper will generate unwanted shadow artefacts. Hard fine paper used for photographic paper is ideal and Rives commercial paper (10kg ream) was commercially recommended (British and Colonial Printer and Stationer, 1893)^[188].

A gelatinous ink is used in printing. For a successful image transfer the substrate surface must be treated^[189] and keyed or given a tooth. (Geddes, 1896)^[190]The paper's printing surface had to be made waterproof (British and Colonial Printer and Stationer, 1893)^[191] and was coated originally with collodion. An alternative surface dressing was albumen. However the most popular surface treatment was shellac (Sutton, 1870)^[192] (British and Colonial Printer and Stationer, 1893)^[193].

4.10.2 Calendering

The paper is rolled in calendering press to ensure that it is flat and even (Photographic News, 1884)^[194] (Sutton, 1870)^[195] (British and Colonial Printer and Stationer, 1893)^[196] This was reported to be the most expensive piece of equipment needed for the

¹⁸⁷ Woodbury, W.B. (18/08/1865) The New Photo-Relief Printing Process In Semi-Transparent Ink. Photographic News. IX

¹⁸⁸ Unknown (13/04/1893) Extract - Messrs. Waterlow & Sons' Photo-Mechanical Printing Works. British & Colonial Printer & Stationer. XXXI

¹⁸⁹ Unknown (01/06/1870) Editorial. The Photographic Art Journal.

¹⁹⁰ Geddes, J.D. (1896) Affiliation of Photographic Societies. Six Lectures on "Photography with the Bichromate Salts" iv) Woodbury Printing. The Photographic Journal. 36 (May 29), pp.270-273.

¹⁹¹ Waterlow, G.S. (30/03/1888) Modern Photographic Engraving and Printing (Part 2). Photographic News. XXXII

¹⁹² Sutton, T. (01/03/1870) A Week at the Woodbury - Printing Establishment of MM. Goupil at Ansieres, near Paris. The Photographic Art Journal.

¹⁹³ Unknown (13/04/1893) Extract - Messrs. Waterlow & Sons' Photo-Mechanical Printing Works. British & Colonial Printer & Stationer. XXXI

¹⁹⁴ Unknown (10/04/1884) The Woodbury Process: Fifth Article. Photographic News. XXVIII

¹⁹⁵ Sutton, T. (01/03/1870) A Week at the Woodbury - Printing Establishment of MM. Goupil at Ansieres, near Paris. The Photographic Art Journal.

¹⁹⁶ Unknown (13/04/1893) Extract - Messrs. Waterlow & Sons' Photo-Mechanical Printing Works. British & Colonial Printer & Stationer. XXXI

process. A suitable press of demi-size cost £200, (Photographic News, 1884)^[197] four times the cost of the hydraulic press needed to make the intaglio plates. Paper is calendered between sheets of burnished steel and heavily rolled with the pressure being gradually increased during the rolling process. This ensures an even thickness. The paper must be handled carefully and protected from moisture.(Ibid)^[198]

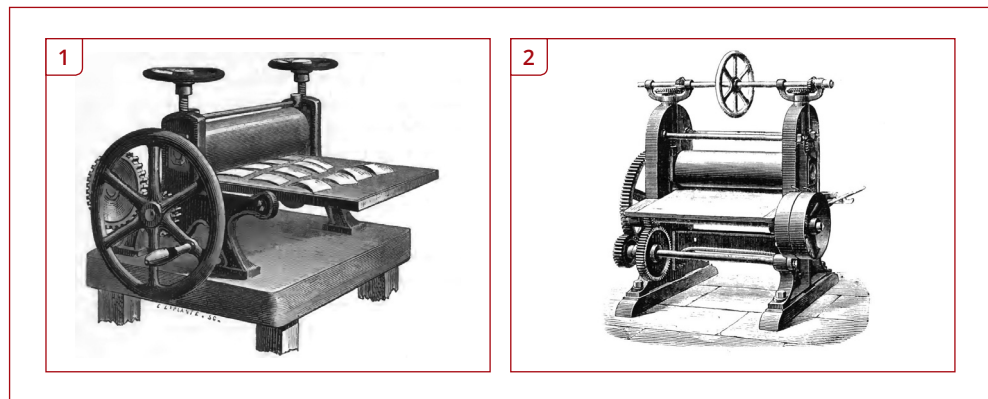

Figure 4.60 1) Paper calendering press published in A History and Handbook of Photography, TISSANDIER, Gaston (1877) 2) Woodburytype calandaring press (reportedly the most expensive piece of equipment needed to complete the process)

4.10.3 Sealing the paper with shellac

Sealing the paper took place in an environmentally controlled room at 90°F / 32°C. (Photographic News, 1884)^[199] Shellac and borax was mixed and used to seal the surface of the paper. (Ibid)^[200] On some occasions the surface dressing was tinted with carmine so that the final prints would resemble photographic prints.(Ibid)^[201] The surface dressing was prepared and poured into a coating tray. (Ibid)^[202] Two sheets of paper were taken and placed back to back. Holding the paper by opposite corners was run through the surface dressing and held up to dry with a drip tray underneath. Once dry the corners could be split apart or trimmed at edges and the paper separated due to the coating being on the outer faces of the leaves.(Ibid)^[203]

Several methods were tried as part of this investigation. It was found that commercially bought resin coated photographic paper was the best for monochromatic

¹⁹⁷ Unknown (10/04/1884) The Woodbury Process: Fifth Article. Photographic News. XXVIII

¹⁹⁸ Unknown (10/04/1884) The Woodbury Process: Fifth Article. Photographic News. XXVIII

¹⁹⁹ Ibid

²⁰⁰ Ibid

²⁰¹ Ibid

²⁰² Ibid

²⁰³ Ibid

Woodburytypes. This paper would need to be fixed with standard darkroom chemicals and left to dry before use. The processes similar to preparing paper for carbon printing can also be used however a smooth calendered paper must be selected.

4.10.4 Surface emulsion / Sizing and keying the surface

A gelatine emulsion is applied to the surface by floating across the emulsion or by rubbing it on with a soft cloth. (Ibid)^[204] The emulsion was generally a diluted version of the un-pigmented gelatine ink. (Ibid)^[205] The mix may include a small amount of shellac. (Ibid)^[206] Once coated the paper is left to dry. If only a gelatine key is used then chrome alum is brushed onto the paper to harden the gelatine key and left to dry again. This will allow the printing ink to adhere to the paper without wetting or re-melting the paper's gelatine coating. This study used a 3% gelatine key which was then treated with 12% chrome alum to harden it.

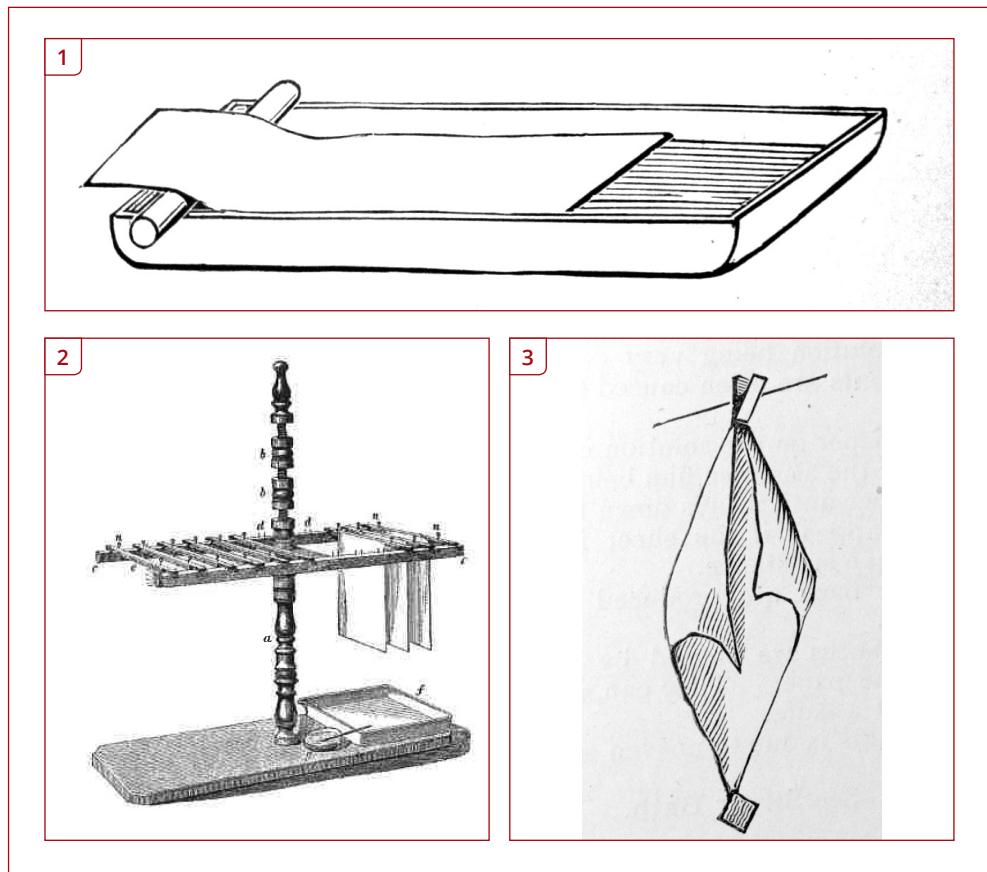

Figure 4.61 1) Coating tray 2) Drying rack for paper 3) Paper drying with weight attached

204 Ibid

205 Ibid

206 Ibid

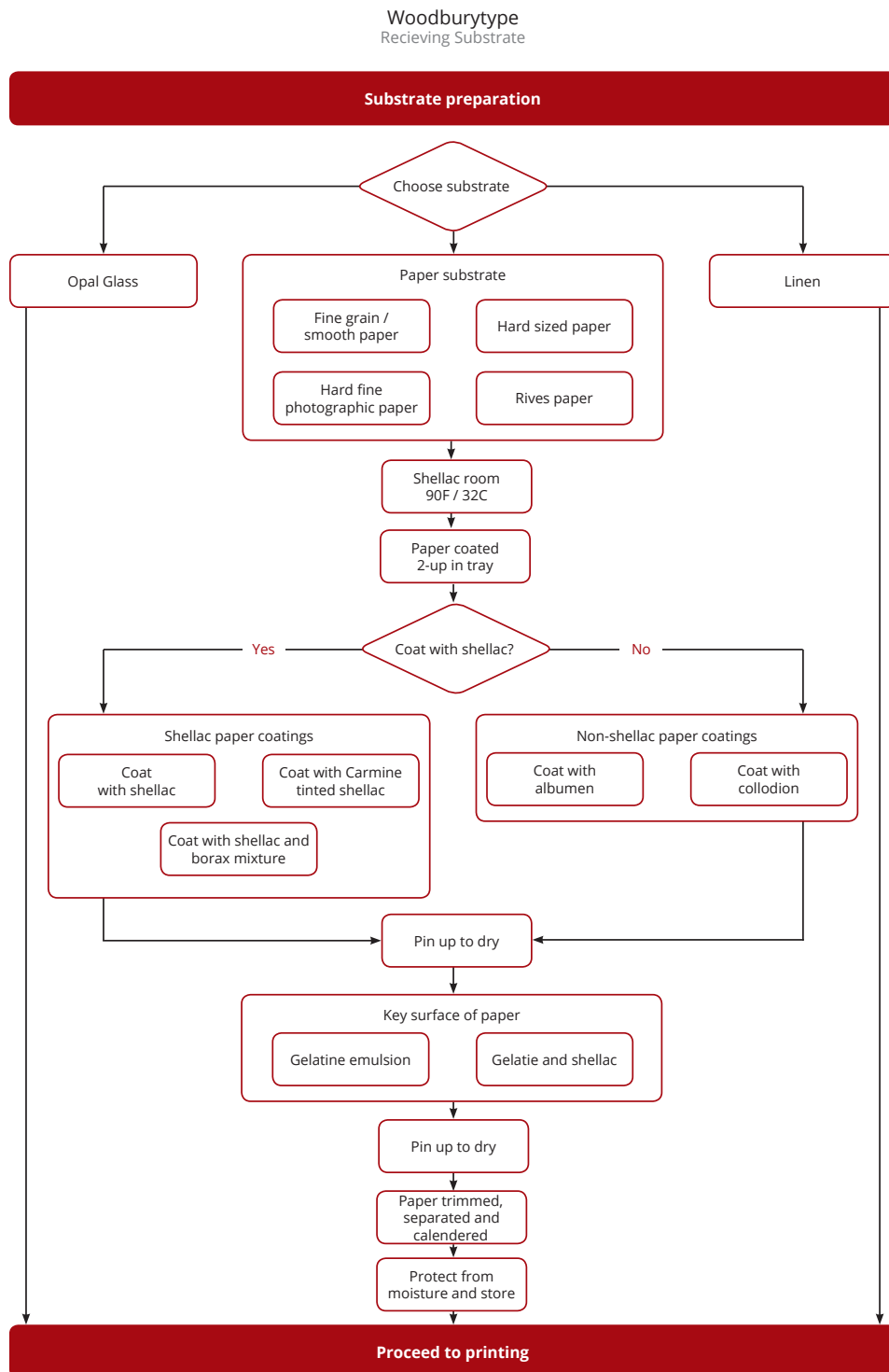

Figure 4.62 Substrate preparation

4.11 Stage 7 - Printing

There were several types of printing presses that were used. Woodbury used a makeshift model for his initial demonstration which was for essentially 2 hinged planks of wood with a rabbeted lid and spring mounted glass platen (Woodbury, 1865)^[207].

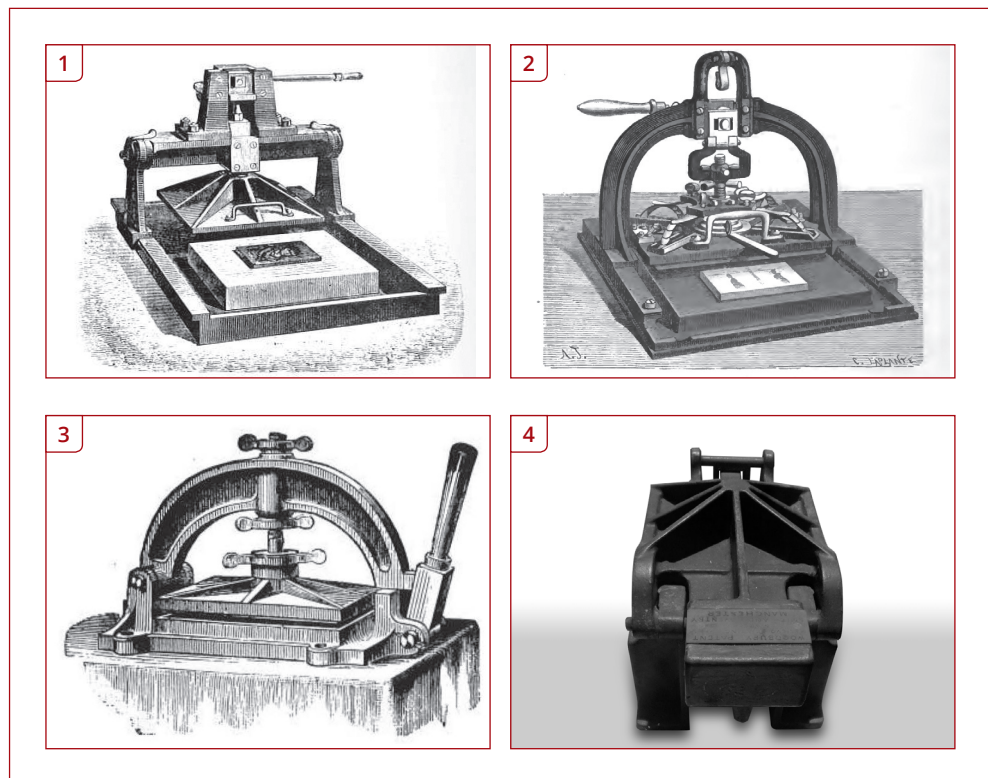

Figure 4.63 Illustrations of printing presses 1-2) Woodburytype / Stanotype Press published in *A History and Handbook of Photography*, TISSANDIER, Gaston (1877) 3) Photoglyptic Press 4) "Woodbury Patent Relievo printing press", National Science and Media Museum, 1888-163 Pt6

As the potential of the process grew, hinged metal presses were used allowing for flat even pressure to be applied to the plate. Albion presses and even letterpresses (Geddes, 1902)^[208] were acceptable alternatives. Columbian, Albion and Dry Mount presses were tested within this study along with makeshift presses. When the process was in full production there were two distinctive presses specifically for Woodburytype printing and a later one for a variation of the process. These were known as an (English)

²⁰⁷ Woodbury, W.B. (18/08/1865) *The New Photo-Relief Printing Process In Semi-Transparent Ink*. *Photographic News*. IX

²⁰⁸ Geddes, J.D. (17/10/1902) *Photography as Applied to Illustrations and Printing (Part 2)*. *British Journal of Photography*. XLIX

Woodburytype press, a (French) photoglyptie press and a Stanotype press. In Germany the process was called the Woodburydruck.

The English Woodburytype press had a hinged lid and was adjusted from below to allow for even pressure (British & Colonial Printer & Stationer, 1893)^[209]. It was capable of producing more pressure than the French press (British & Colonial Printer & Stationer, 1893)^[210]. It was also lighter to operate than the French press (British & Colonial Printer & Stationer, 1893)^[211].

The French photoglyptie press was easily identifiable as it had a metal bow which arched across the the platen (British & Colonial Printer & Stationer, 1893)^[212]. Pressure could be adjusted from the top. It was heavy and was said to fatigue the operator more quickly than the English press. (British & Colonial Printer & Stationer, 1893)^[213]

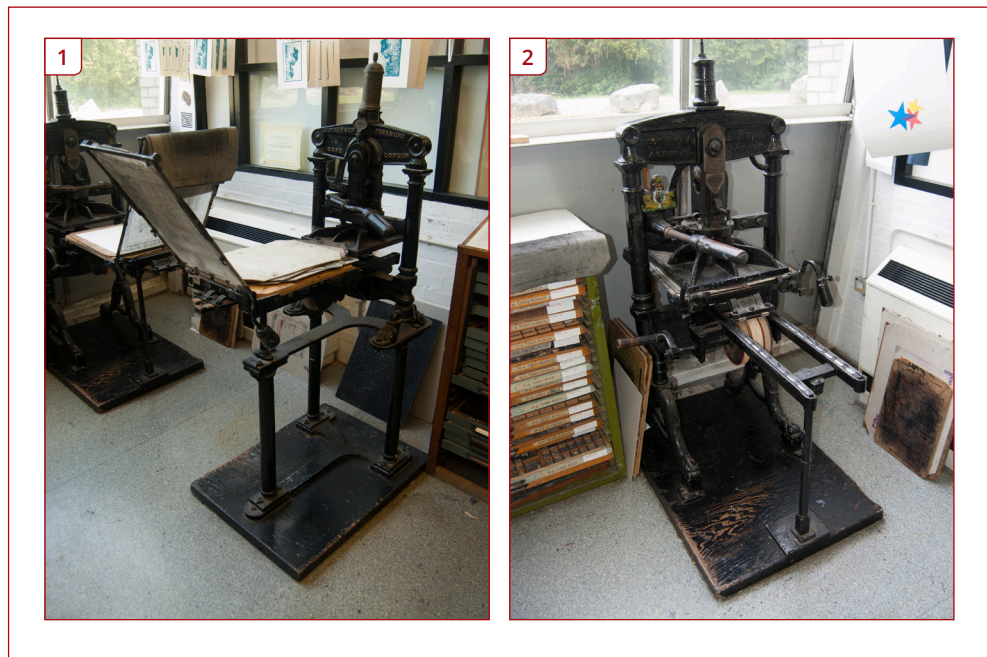

Figure 4.64 1) Albion Press at CFPR 2) Columbia Press at CFPR

²⁰⁹ Unknown (13/04/1893) Extract - Messrs. Waterlow & Sons' Photo-Mechanical Printing Works. British & Colonial Printer & Stationer. XXXI

²¹⁰ Ibid

²¹¹ Ibid

²¹² Ibid

²¹³ Ibid



Figure 4.65 1) Makeshift printing press using platen and weights 2) Kennet Dry mount press suitable for printing Woodburytypes

4.11.1 Preparing the platen (optional)

The lid of the printing press must be assessed before use. If the lid of the printing press is not smooth, a flat and level platen may be attached. Historically the lid of the press was gently heated. A sheet of thick plate glass is used as the print platen. It was ground with emery and also gently warmed. A rubber or elastic cement such as marine glue, Canada balsm or gutta percha was spread on the glass and the lid is closed adhering the glass platen to the lid of the press.

4.11.2 Preparing the print bed

The intaglio printing plate is fixed into position on the central (sometimes movable carriage) area of the print bed. This was done via two methods, adhesive or plaster.

For the adhesive method 2 – 3 cricket sized balls (70mmØ - 73mmØ) (British Standard 1994) ^[214] of gutta percha are warmed either by warm water or by the hand so that they become more pliable. This is spread out evenly to form a somewhat level plastic cushion. The intaglio is placed upon the adhesive. The platen is closed and the height adjusted by screws so that the intaglio plate adjusts under the gentle pressure ensuring an even parallel contact is made with the tympan. A tympan is a layer of packing, placed between the platen and the paper to be printed to equalize the pressure over the whole forme. – The press is left until the adhesive sets.

For the plaster method a stiff mix of plaster of Paris is made and levelled. The intaglio is placed on top of the plaster and a sheet of paper is placed on top of the intaglio to

214 BS 5933 1994

protect it. The lid of the press is closed; again applying gentle pressure to the intaglio and ensuring that parallel contact is made. The lid remains closed until the plaster sets.

4.11.3 Final intaglio preparation

Once the intaglio is fixed into place the press is opened, (in the case of albion presses the central carriage is run out). Further subtractive plate editing can now take place where blemishes may be scrapped off. If the intaglio has a border of ¼ inch drainage channels can be scrapped into the plate this will allow excess gelatine from the printing ink to drain away. The intaglio is cleaned and then lightly greased with olive oil or a mix of oil and parafin. Any excess is wiped off the plate.

4.11.4 Removable platen (optional)

If no platen was affixed to the lid) a sheet of plate glass may be used as one during the printing process. Place the glass on top of the intaglio and adjust the press so that even parallel pressure is applied. Once set, open and remove the platen. This study used a 10mm acrylic sheets as a removable tympan / platen.

4.11.5 Printing Ink

The printing ink is a mixture of pigment and a gelatine vehicle. The vehicle is prepared in a similar manner to un-sensitized tissue. Plasticisers (see 3.3.15) can be added if preferred and biocides should the ink need to be stored for later use. Maier states that isinglass (fish gelatine) provides more brilliancy to the prints (Ott, 1880) ^[215].

Waste ink can be collected, re-melted and re-used many times, making it economical. Skin Gelatine is preferred for carbon tissues as it contains more glutin and has better adhesion^[216]. Bone gelatine contains more chondrine and Elder states that it gives a greater brilliancy and contrasts to the prints^[217].

4.11.6 Setting strength

The gelatine mix strength needs to be adjusted for the setting power of the ink in hot and humid weather a higher gelatine concentration is required in the ink than in winter. Weather and humidity affects gelatine strength(The Photographic Journal, 1865) ^[218]. While stated that a solution of 10% gelatine should not melt below 30% (Ott, 1880)^[219] the gelatine used in this study had a melting point between 26°C-28°C at a 10% strength. The gelatine strength also affects the gloss and sheen of the ink. Weak

²¹⁵ Ott, A. (25/06/1880) Examination and Selection of Gelatine for Photo-Mechanical Printing. Photographic News. XXIV

²¹⁶ Ibid

²¹⁷ Ibid

²¹⁸ Unknown (15/12/1865) Mr. Woodbury's Photo-Relievo Process. The Photographic Journal.

²¹⁹ Ott, A. (25/06/1880) Examination and Selection of Gelatine for Photo-Mechanical Printing. Photographic News. XXIV

gelatine mix used for pigment (The Photographic News, 1865)^[220]. In this study it was observed that it was more difficult to print with ink that had a low gelatine percentage (10%) as it was more prone to producing bubbles in the print. The viscosity of the ink was best controlled by adjusting the gelatine strength of the ink and a percentage of 20-25% gelatine worked best for the empirical studies in this research.

4.11.7 Ink concentration in relation to intaglio depression

The pigment concentration was mixed in relation to relief height, Woodbury's initially ink was pigmented so that it was opaque when 3-4 inches deep (Woodbury, 1865)^[221]. Shallow relief intaglio plates require a higher concentration of pigment in comparison to intaglio plates with a higher relief. Test prints are therefore required to check the concentration of pigment within the ink and the pigment mix adjusted accordingly.

4.11.8 Pigment

Any pigment could be used provided it could be mixed to an aniline solution (Woodbury, 1865)^[222]. Traditionally the gelatine was pigmented with lamp black or carbon black.(Photographic News, 1883)^[223] Essentially this is soot that has been collected from a small lamp. Powdered pigments were extremely difficult to mix with the gelatine evenly and smoothly. Mixing powdered pigment directly into the gelatine vehicle was not advised. Best practice was to dissolve the pigment with water and then introduce the liquid pigment to the gelatine vehicle solution.

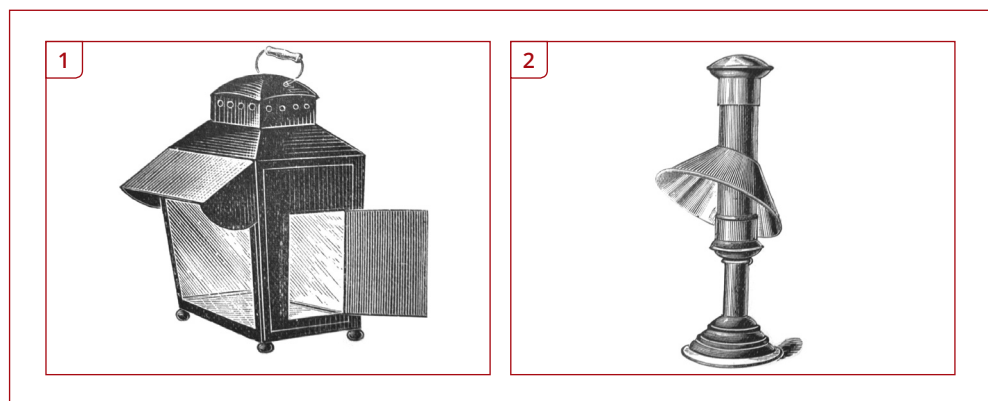

Figure 4.67 1-2 Lamps used to produce carbon pigment that could be brushed off the collection hood.

²²⁰ Woodbury, W.B. (18/08/1865) The New Photo-Relief Printing Process In Semi-Transparent Ink. Photographic News. IX

²²¹ Woodbury, W.B. (12/05/1865) New Patent: Complete Specification of Patent Obtained by Walter Bently Woodbury, Manchester, filed 23rd March, 1865. British Journal of Photography. XII

²²² Woodbury, W.B. (18/08/1865) The New Photo-Relief Printing Process In Semi-Transparent Ink. Photographic News. IX

²²³ Unknown (14/09/1883) The Woodbury Process: First Article. Photographic News. XXVII

Commercial carbon pigments typically were inks or watercolour paints, (Wortley, 1871)^[224] described generically as 'colour' quite often in a neutral colour so that they could imitate a sepia toned photographic print, (Tissandier, 1876)^[225] nevertheless the colours and combinations of colours could be varied (Tissandier, 1876)^[226] and any colour could be used provided it was permanent (Woodbury, 1865)^[227]. Newton's colour for carbon was a brand that was commercially bought, (Photographic News, 1884)^[228] and the company is still producing inks today and these were tested within this study. (Appendix 4)

A base colour of black was used either from India ink or a carbon / lamp black to which a second colour was added to increase the warmth of the hue.

Secondary colours generally were made by combining a base black with a second pigment. The principal colour combination was Indian ink and carmine (British & Colonial Printer & Stationer, 1893)^[229] Other colours used included indigo; crimson lake; madder brown; sepia (British & Colonial Printer & Stationer, 1893)^[230]; alizarine lake (Photographic News, 1884)^[231] bartolozzi red (Geddes, 1896)^[232] and a generic term bistre (Gill, 1969)^[233] which could range from a yellow brown to a dark brown.

Prints were made to look like photographic works and so quite often were printed on tinted paper as a mix of black and a combination of secondary colours.

4.11.9 Fluidity

The ink was mixed and kept warm so that it stayed fluid throughout the printing process. Ink could be recycled during the printing process by re-melting the overspill that was forced out from the plate or scraped off the edges of the prints. The printing

²²⁴ Wortley, Stuart H. Lieut. Colonel (25/08/1871) Extract - Official Report of Photography in the International Exhibition of 1871. *British Journal of Photography*. XVIII

²²⁵ Tissandier, G. (01/01/1876) A History and Handbook of Photography (Part II, Chapter II). A History and Handbook of Photography.

²²⁶ Ibid

²²⁷ Woodbury, W.B. (18/08/1865) The New Photo-Relief Printing Process In Semi-Transparent Ink. *Photographic News*. IX

²²⁸ Unknown (02/05/1884) The Woodbury Process: The Sixth Article. *British Journal of Photography*. XXVIII

²²⁹ Unknown (13/04/1893) Extract - Messrs. Waterlow & Sons' Photo-Mechanical Printing Works. *British & Colonial Printer & Stationer*. XXXI

²³⁰ Unknown (13/04/1893) Extract - Messrs. Waterlow & Sons' Photo-Mechanical Printing Works. *British & Colonial Printer & Stationer*. XXXI

²³¹ Unknown (02/05/1884) The Woodbury Process: The Sixth Article. *British Journal of Photography*. XXVIII

²³² Geddes, J.D. (29/05/1869) Woodburytype Printing (Photography with the Bichromate Salts). *The Photographic Journal*.

²³³ Gill, A.T. (1969) One Hundred Years Ago. *The Photographic Journal*. 109 (November), pp.619-621.

ink was said to improve through use (Sutton, 1870)^[234]. It was observed that the ink did improve and produce better prints through use. There were several observations I noted. As the ink was used and recycled by re-melting it, it became slightly contaminated with the release agent that was being used on the plate. I found that the initial prints would stick and the the gelatine would tear as it was being pulled from the plate. As printing continued this would happen less and less until prints were coming away clean from the plate. It seems plausible that this was due to the release agent being introduced to the ink.

For this study ink was made in batches and decanted off into smaller volumes for printing. This was to avoid disturbing the ink and introducing bubbles. Recycled ink when cooled was carefully introduced (to avoid splashing) to the main batch and was continually kept fluid. This in turn allowed bubbles that may form to disperse before being decanted off. Bubbles can also be removed rapidly through the use of a vacuum (similar to the method described for Woodburytype printing with silicone in Appendix 5). Adding a small amount of IPA to the ink reduces the surface tension of the fluid in the same manner as making the gelatine tissue. Surface bubbles can also be removed from the mix with a pipette.

The last observation is that as the gelatine is heated evaporation takes place. This over a prolonged period of time will increase the gelatine percentage slightly in the mix. This inturn has an effect on the viscosity and setting point of the gelatine ink. The higher the setting point the more time you have as a printer to work with the ink in a usable state.

4.11.10 Gelatine Strength

Ink was produced in the same manner as the tissue mix. However the strength could be adjusted from 10% gelatine concentration to 25% concentration.

²³⁴ Sutton, T. (01/03/1870) A Week at the Woodbury - Printing Establishment of MM. Goupil at Ansieres, near Paris. The Photographic Art Journal.

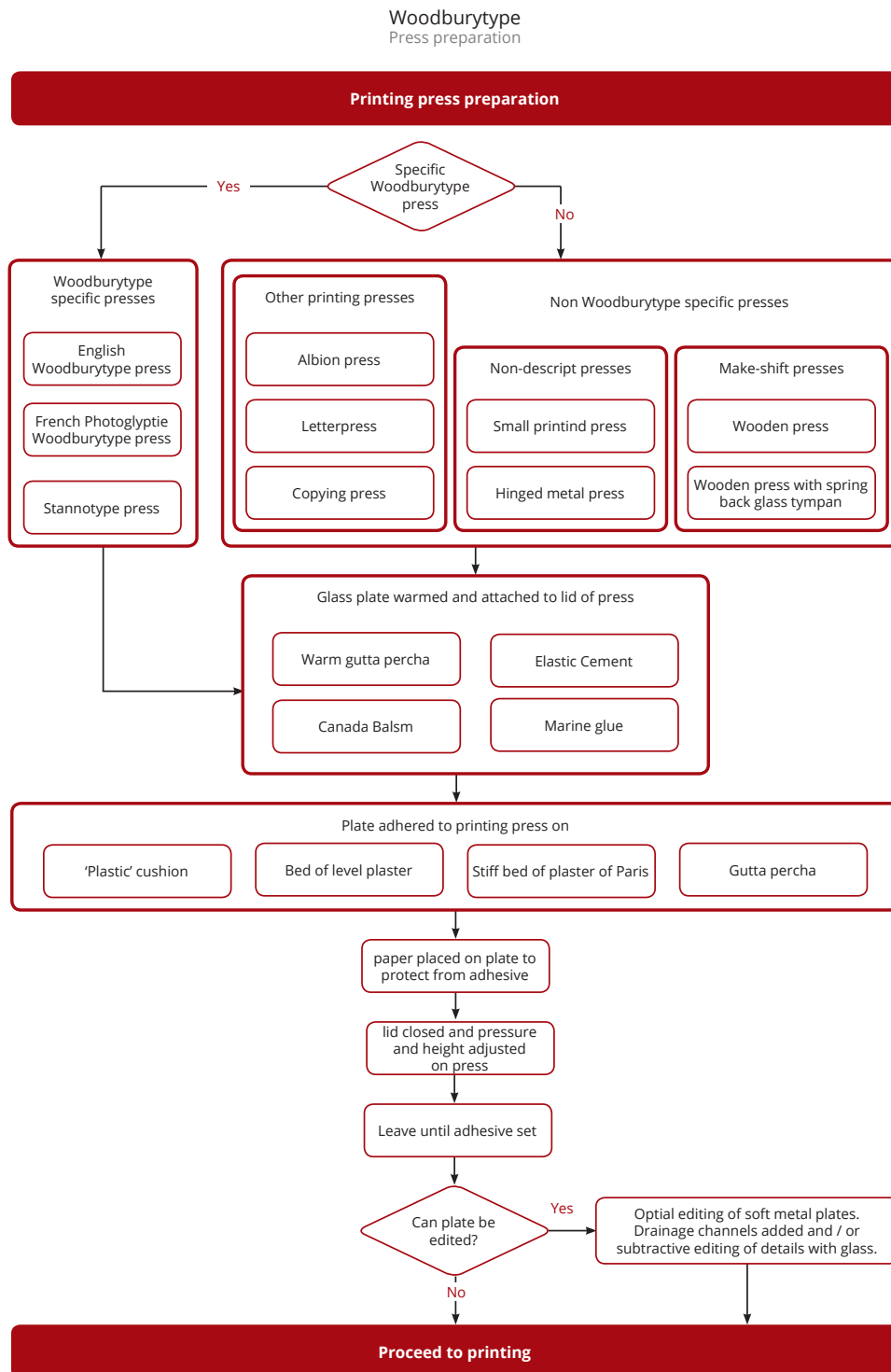

Figure 4.66 Printing press preparation

4.11.11 Printing

The printing plate is opened and the intaglio is dampened with olive oil or a mixture of olive oil and paraffin. This is done with a rag or a piece of cloth. The warm ink is poured on top the intaglio plate. Generally this is described as a small quantity of ink up to 1/8th of a plate, other accounts say that half of the intaglio is covered. This is solely dependent on the printers preference. The paper is placed with the emulsion surface face downwards onto the ink and intaglio, (a tympan is placed if necessary on top of the paper). The press lid is closed so that gentle pressure is applied. Intaglios with more pronounced depressions required more pressure than those with subtle depressions. As the lid is closed excess gelatine is pressed across the intaglio and off the intaglio with the aid of the drainage channels. The remainder of the ink is trapped in the depressions of the intaglio plate. The lid is bolted and locked shut and kept this closed position until the gelatine has set which takes approximately 5 minutes (although this is environment dependent).

Upon opening the press the print is lifted or "pulled". The print will be in an extreme relief and very pronounced. It is a mould of the intaglio. Any excess ink that was forced off the plate is scraped off the edge of print. The edge of the print is wiped with a damp cloth and the reclaimed ink is recycled in the melting pot. The print is left on a stackable canvas frame to dry. Excess ink is collected from the printing press and recycled. The plate is cleaned and re-dampened with the oily rag and ready for another print. Woodbury made attempts to produce a method that allowed for prints with clean edges. A method was described in a patent but it was unsuccessful.

Large scale production printing involved the use of five presses placed on a carousel table. This enabled the operator to close the lid on the press and while the ink was setting they could rotate the table so they could continue printing on the next press. This method facilitated multiple prints to take place without stopping production. It was possible to print 2 up in each print pass by fixing 2 plates into the press.

Printing one print at a time is a very slow process. While it takes approximately 5 minutes for the ink to set there is also the clean down of the plates and workstation in-between prints. On average in this study it took 15 minutes per print. If the press is opened too soon the print is spoiled and it then takes longer to clean the plate as there will be gelatine still on the intaglio surface.

It was also observed that when oil was used as the release agent it would sit on the surface of the print as it dried. Once completely dried this could be wiped off with a tissue. It could take several days for the oil to be completely removed from the surface of the print as it would also be mixed into the printing ink and gradually resurface.

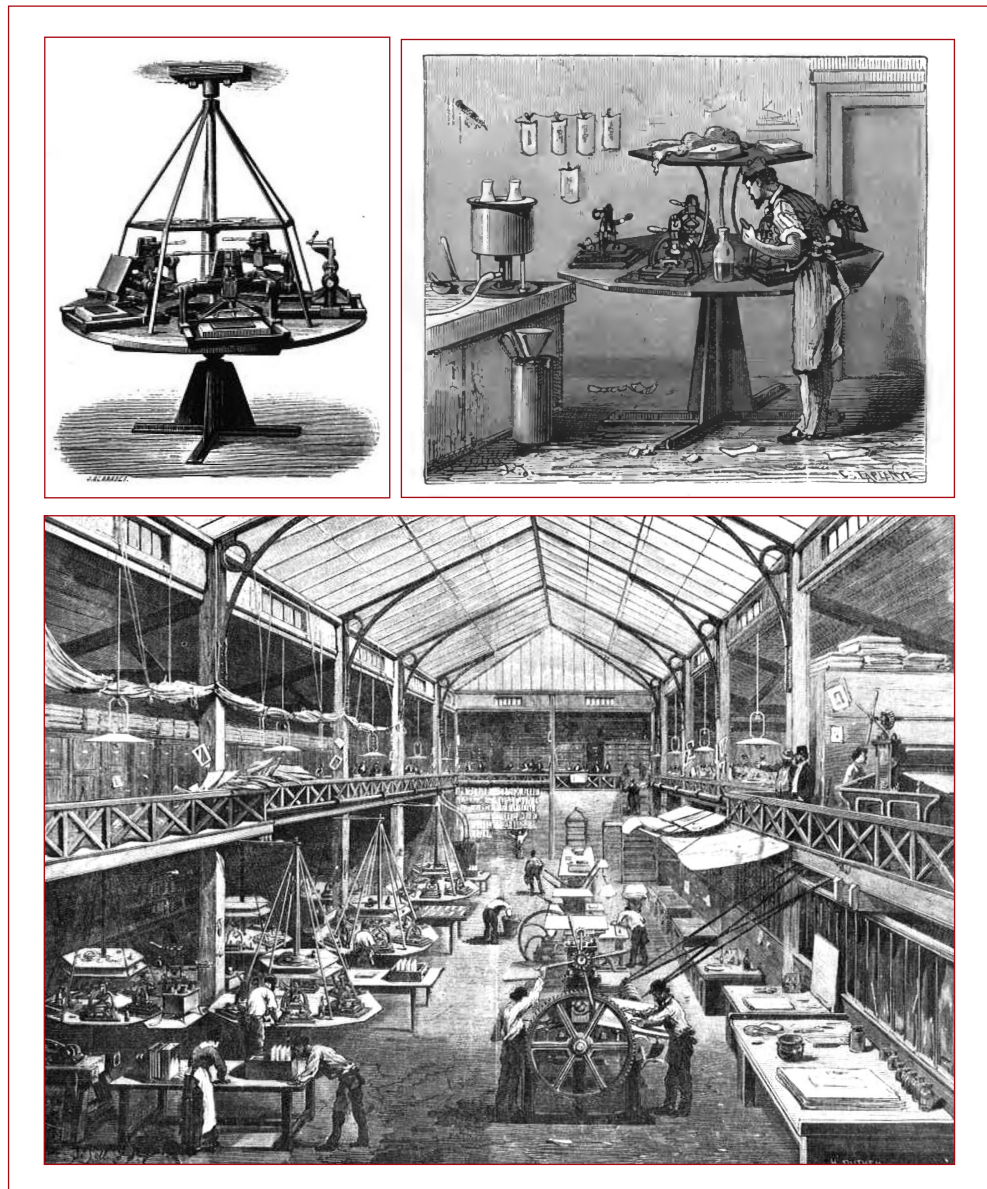

Figure 4.68 1) Woodbury carousel printing press. published in *The Engineer* 1888 2) Printer printing at press, published in *A History and Handbook of Photography*, TISSANDIER, Gaston (1877) . 3) L'Établissement photographique de MM. Goupil et Cie, à Asnières, wood engraving by H. Dutheil, published in *L'illustration*, no. 1572, 12 April 1873, p. 253. Note the Woodburytype carousel tables to the left of the illustration



Figure 4.69 1) Woodburytype print wet and in relief 2) Woodburytype print dry and with shrunken relief.

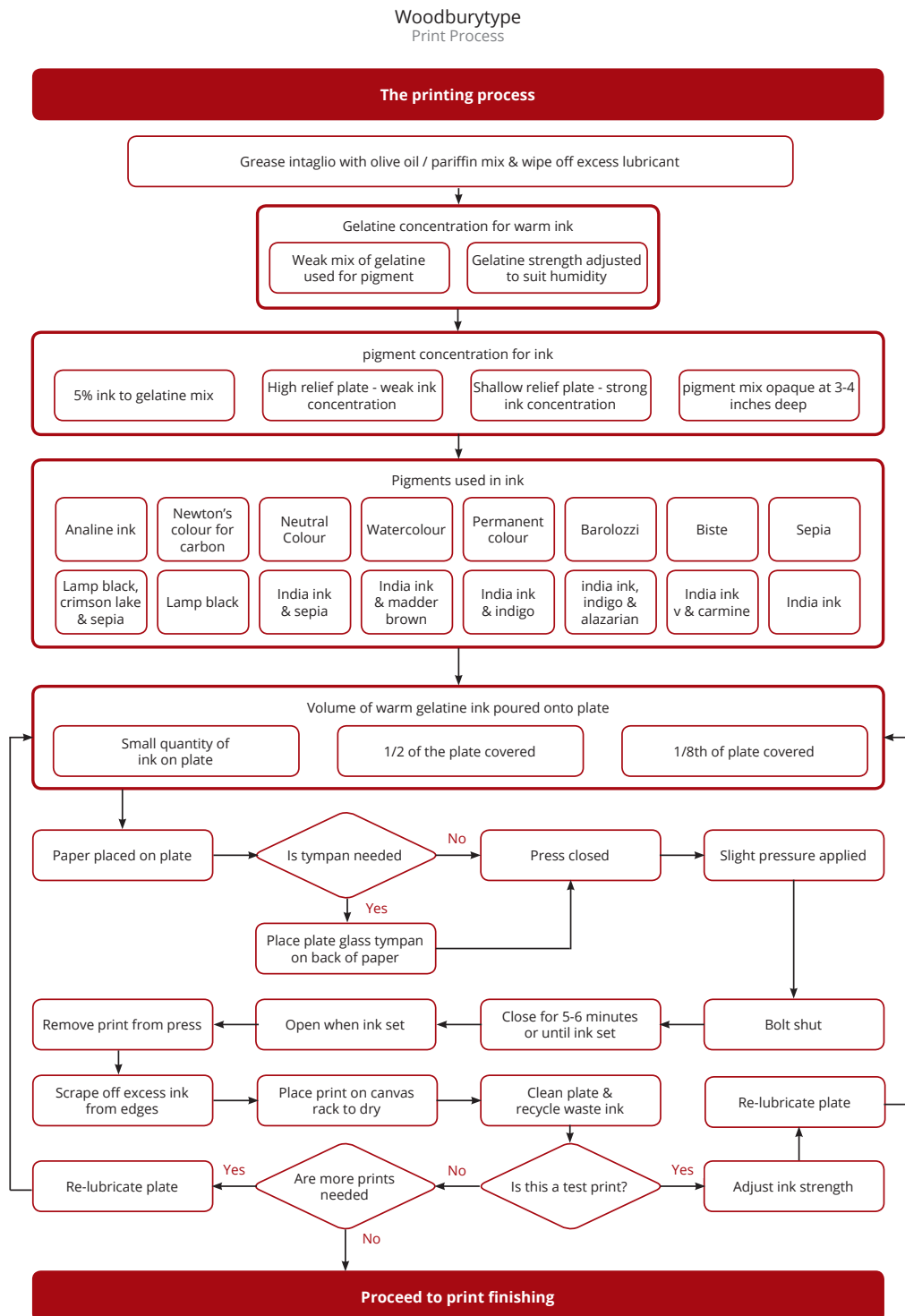

Figure 4.72 The printing process

4.12 Fixing and finishing the print - Stage 8

4.12.1 Fixing the print

After the prints have dried the relief of the print will be reduced considerably. In early stages the prints were simply varnished but later adaptations involved bathing the print in a fixative solution such as tannin, sumach or nut galls. The most popular method was to bathe in a bath of Chrome Alum for five - ten minutes and then rinse in clean water. The prints are then placed on the canvas drying frames and left to dry. Once dry the print could be varnished and left to dry again. As described in 4.8.11 the solution of Chrome Alum needs to be freshly made



Figure 4.70 Woodburytype print of the test image pulled from a lead plate. Notice the mottled edges



Figure 4.71 Woodburytype print of the test image from a lead plate. Large white dots on the print is caused by bubbles on the prints. Small white dots are caused by reflection on gelatine relief within the print.

4.12.2 Finishing the print

Once completely dry the print is trimmed to size where any excess ink that remained is removed to leave the final print with clean sharp edges. The print is then passed through a calendering roller and mounted or 'tipped' into the final publication or display.

Woodburytype
Print Finishing

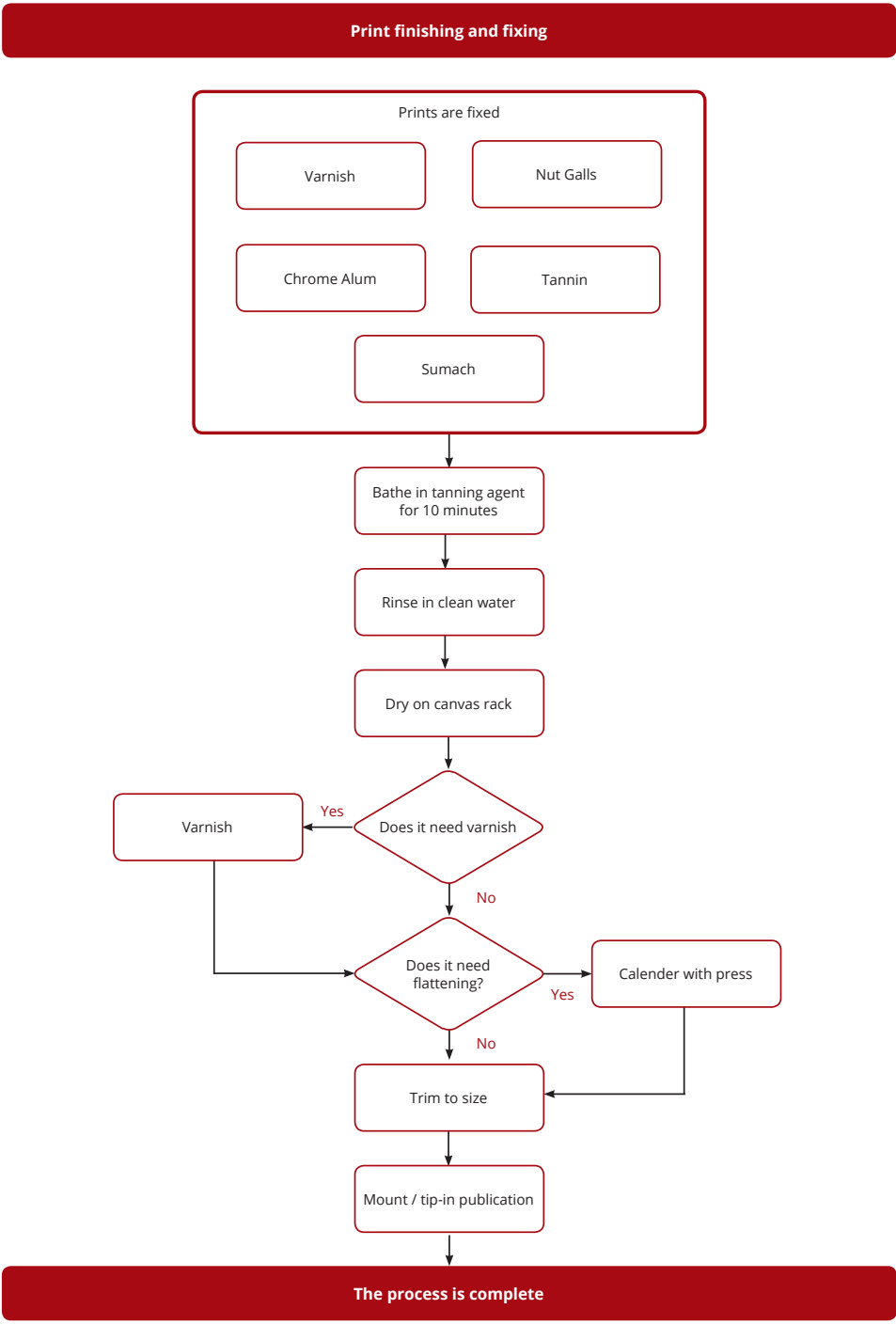

Figure 4.73 Print finishing and fixing

4.13 In summary

The Woodburytype was a very difficult process to execute successfully. The written descriptions of the historical accounts may not have been the most consistent method or best method but simply an interim revision through technological advancement or a more evolved knowledge by current printers before the process became redundant.

As demonstrated the process is created in eight stages. Each stage is comprised of a series of linear steps. I have presented the stages and steps within this chapter as a series of written accounts summarised as flow diagrams illustrating the process holistically.

The original descriptions of the Woodburytype did not present many illustrations. The half-tone printing process was not yet commonplace so no half-tone photographic representations of the process was observed by myself in any of the historical literature. Photography was still in its infancy and any photographic description of the process would have been very expensive and practically impossible to capture successive steps in a laborious methodology such as this one.

I suspect that lack of pictorial instruction is possibly one reason why the recreation of the process has proven difficult for contemporary users.

Publications such as the spirit of the salts (Webb, Reed, 1999) ^[235] illustrate the photographic steps with great detail, however there are few if any visual aids that may be of assistance for the Woodburytype. It is hoped that cataloguing the individual steps of the Woodburytype process and making it available will contribute to the working knowledge of the process.

This chapters' assessment of the Woodburytype provides the background knowledge needed to enable the empirical research to be undertaken in Chapter 6 - '*Colour printing methods for the reproduction in continuous tone of digitally printed colour artworks*'. Chapter 6 will build upon the knowledge presented here.

235 Webb, R. and Reed, M. (1999) Spirit of Salts. A Working Guide to Old Photographic Processes. London: Argentum, Aurum Press.

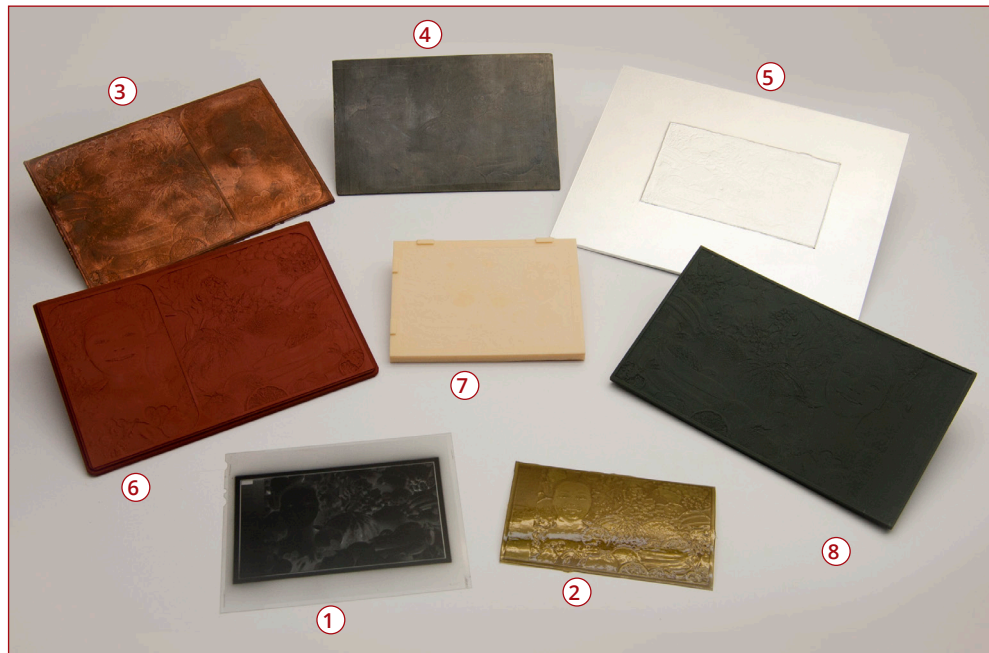

Figure 4.74 Example of all elements generated through this research to produce Woodburytypes.
 1) Negative 2) Gelatine relief 3) Electrodeposition printing plate 4) Lead printing plate 5) Stannotype printing plate 6) Silicone printing plate 7) Plate produced digitally by CNC 8) Plate produced digitally by 3D printing. Note 7–8 will be discussed in the Chapter 5

4.13.1 Further development of historical process

Using modern negative production process it is possible to produce registerable gelatine reliefs. There is a scope to develop the historical process further so that it can register and print in colour.

The Woodburytypes while capable of producing beautiful permanent prints never managed to perfect colour images purely through the Woodburytype method. This is something that will be addressed in Chapter 6.



Figure 4.75 Complete set of colour separations for Woodburytype printing 1) Cyan separation 2) Magenta separation 3) Yellow separation 4) Black separation

4.13.2 In the next chapter

Chapter 5 introduces the contemporary digital methods that are used to develop a colour printing method. This chapter discusses additive and subtractive manufacturing processes such as 3D printing and CNC milling which are used to make specialist intaglio printing plates. It will also discuss methods of testing and standardisation for printmaking to ensure repeatability.

5 Review of contemporary technology for the colour development of the Woodburytype process

Synopsis: This chapter introduces characteristics of digital imaging and specific manufacturing processes that are utilised within this study to produce printing plates. This chapter begins by explaining the basic elements that when combined make a digital image. From this it expands on how the 2D components of a greyscale image can be used to produce a 3D model that can then be output through CNC milling or 3D printing. Test procedures for the visual assessment of images and for mixing fluids are also discussed to ensure that the printed image will contain a satisfactory tonal range.

5.1 Digital Imaging and transitioning from half-tone to continuous tone.

5.1.1 Analogue and digital images

Currently a silver gelatine photograph is near continuous tone and able to convey vast tonal ranges between the darkest and lightest tones in a smooth continuous gradient. This is possible because of the number of microscopic silver particles that are arranged randomly in dense or sparse clusters within the photographic negative. A printed digital image attempts to do the same, through half-toning. Digital systems require a binary system of storing and transmitting the information which results in the gradient from dark to light being displayed as a series of equal tonal steps which are then translated and output as digital half-tones. (Lau, Ace, 2008)^[1]

When converting an analogue image into a digital format or ‘sampling’, the method used to capture the information must do so at a higher frequency than the human visual system (HVS) can perceive (Green, 2005).^[2] This enables any reproductions that are made to appear identical to the original but only on the condition that the number of digital binary steps also exceed the ability of the HVS. In other words if the method of

¹ Lau, D.L. and Ace, G. (2008) Modern Digital Halftoning. 2nd ed. CRC Press, Taylor & Francis Group.

² GREEN, P., 1995. Understanding digital colour. 1 edn. Pittsburg, Pennsylvania, USA: Graphic Arts Technical Foundation.

inputting and outputting the image exceeds the limitations of the HVS the original and the reproduction will appear identical to a human observer. Conversely the lower the sampling precision, the more noticeable the difference between the reproduction and the original to the human observer. (Green, 1995) ^[3]

The HVS however doesn't always recognise these changes in equal incremental steps in the sampling process. Each incremental step within a digital image file is known as a grey level. The total number of grey levels available are known as a grey scale. (Green, 1995) ^[4]

5.2 Digital Tones

5.2.1 Bit-depth

The total number of tones or grey levels that are available in a digital image is known as the bit-depth. Bit depths follow a logarithmic scale that expands exponentially by doubling in value, eg, 2, 4, 8, 16, 32, 64 etc.

Half-tone printing is done with a binary grey scale that contains 2 values, black and white. Ink is either on the page or it is not. Only 1 bit of data is required to display these values as a gradient. It is stated as having a grey level of 2^1 (2×1) or 1 bit depth.

If a gradient consisting of 16 greys is required, then a bit depth of 4 (grey level of 2^4 or $(2 \times 2 \times 2 \times 2)$) or higher is necessary for the digital file (Johnson, 2005). ^[5] Table 5.1 presents this logarithmic scale.

5.2.2 Dynamic range

The dynamic range is the distance between the darkest and lightest values of the image, black and white. The higher the bit depth the greater the number of in-between tonal values that are available for the digital image's dynamic range.

3 GREEN, P., 1995. Understanding digital colour. 1 edn. Pittsburg, Pennsylvania, USA: Graphic Arts Technical Foundation.

4 GREEN, P., 1995. Understanding digital colour. 1 edn. Pittsburg, Pennsylvania, USA: Graphic Arts Technical Foundation.

5 JOHNSON, H., 2005. Mastering Digital Print. 2 edn. USA: Thomson Course Technology PTR.









Total number of greys	Bit Depth	Power (2^n)	Gradient
2	1-Bit	2^1	
4	2-Bits	2^2	
8	3-Bits	2^3	
16	4-Bits	2^4	
32	5-Bits	2^5	
64	6-Bits	2^6	
128	7-Bits	2^7	
256	8-Bits	2^8	

Table 5.1: Table of greys, bit-depth and gradient up to 8-bits

5.2.3 Pixels

Pixels or “picture elements” are the basic building blocks of a digital image. Pixels are the smallest addressable full-colour (RGB) element in a digital imaging device. They contain no shape or form until rendered within an imaging device and are made visible either on a screen or printed.

Pixel information is captured by photosites (or sensels) within cameras or input capture devices, such as scanners. A photosite can only capture and carry the information relating to one colour, i.e. red, green or blue. A pixel is the combination of the information from three photosites. (Stump, 2014) ^[6]

5.2.4 Bitmaps

The value of each pixel is limited to a fixed discrete value. The bit-depth contained within the digital file determines the number of discrete values available to the pixel. To make a digital image, pixels are arranged into rows and columns to form a picture grid. Pixels when arranged in a grid are known as ‘*bitmaps*’. Each pixel within a bitmap is assigned one individual RGB value. When viewed as a complete grid the human visual system interprets this as a continuous tone image. (Tritton, 1996) ^[7] The lowest value that a pixel can be given is 1bit, this produces only 2 shades of grey – black or white.

⁶ STUMP, D., 2014. Digital Cinematography: Fundamentals, Tools, Techniques, and Workflows. 1 edn. US & UK: Focal Press, Taylor & Francis.

⁷ TRITTON, K., 1996. Stochastic Screening. Surrey, UK: PIRA International.

5.2.5 256 Greyscale

Early imaging research indicated that the human eye can only distinguish 150 greys at one time. The minimum bit depth that can accommodate this grey level requirement is 8 bits which has a 256 grey level capacity or 28 grey levels (Green, 1995) ^[8].

5.3 Image resolutions

5.3.1 Spatial resolution

The spatial resolution is a measure of the smallest distinguishable detail in an image. Dots and pixels per unit distance is the common reference of resolution in the print industry. Eg pixels per inch (ppi), and dots per inch (dpi) (Gonzalez, Woods, 2008). ^[9]

5.3.2 Intensity or 'tonal resolution'

The intensity resolution is the smallest discernable change in intensity level. This determined by hardware used. (Gonzalez, Woods, 2008). ^[10] The intensity resolution is also referred to as the bit depth or the tonal resolution (Peterson, 2005). ^[11]

5.3.3 Pixel dimensions

This is the grid size of the bitmap eg 1024 pixels high x 512 pixels wide.

5.3.4 Output / Print resolution

Image resolution for printed out put can be calculated as follows:

2x the lines per inch (LPI) of the output device = the pixels per inch of the digital image.

5.3.5 Artefacts

As will be discussed artefacts in the resolution of an image can go beyond human visual perception. If the input or output resolution of the image falls below the level of human perception artefacts can be detected. Banding is an example of such an artefact.

5.3.6 Banding

If the output device has insufficient grey level capabilities to reproduce a smooth tonal transition from the dark to light tone values the viewer will notice this and an artefact known banding will occur.

Banding or colour aliasing is caused when the bit depth available does not meet the total number of grey levels required to transition smoothly from dark to light tones.

8 GREEN, P., 1995. Understanding digital colour. 1 edn. Pittsburg, Pennsylvania, USA: Graphic Arts Technical Foundation.

9 GONZALEZ, R.C. and WOODS, R.E., 2008. Digital Image Processing. 3 edn. USA: Pearson.

10 GONZALEZ, R.C. and WOODS, R.E., 2008. Digital Image Processing. 3 edn. USA: Pearson.

11 PETERSON, K.A., June 2005. Introduction to Basic Measures of a Digital Image for Pictorial Collections. Washington, USA: Library of Congress.

Banding also occurs in printing when the length of the grey scale vignette exceeds the number of greys available with the output device (Sidles, 2001). ^[12]

For example, if a bitmap vignette consisting of 150 grey values is reproduced as a 7bit (or 2^7) image, it will be observed by the viewer as an uneven gradient transition. The input value of 150 grey levels exceeds the output limit as it can only accommodate 128 grey levels. Therefore the more grey levels available in a grey scale vignette the higher bit depth required for the digital image. Files with a higher bit depth contain more tonal information, and are larger in size.

5.3.7 Just noticeable differences

The 'Just Noticeable Difference' scale (JND), was first investigated by Ernst Heinrich Weber in the 1820s. It was developed to get a better understanding of the tactile senses. It is the minimum amount by which stimulus intensity must be changed in order to produce a noticeable variation in a sensory experience. This change in intensity is known as the 'differential threshold' or the just noticeable difference (Buntain, 2012). ^[13]

Barten (1999) ^[14] used a JND scale where each increment is the minimum amount of contrast change detectable by more than 50% of the time by test subjects. He did this to study contrast sensitivity of the human eye and its effect on image quality. The term JND is used in describing contrast ranges in diagnostic medical imaging displays and is used here to highlight how sensitive the human eye is to tonal changes.

5.3.8 ΔE (Delta-E)

If grey levels are placed on a JND scale where the grey level value is higher than 1 JND between each level of grey, then a human observer will notice a change in the tone of grey and will be able to identify a change. If the grey level value is less than one JND for example $\frac{1}{2}$ JND then the human observer will not notice a change and will see 1 grey for every 2 grey levels available. (Kimpe; Tuytschaever, 2007) ^[15] When describing just noticeable colour differences between any two $L^*a^*b^*$ colours it is known as ΔE and pronounced Delta-E ^[16] (Johnson, 2005) ^[17] When JND is mentioned over the next few paragraphs it is in reference to the noticeable difference in contrast, not colour.

12 SIDLES, C., 2001. Graphic Designer's Digital Printing and prepress hand book. Rockford Publishers.

13 BUNTAİN, C., 2012. Psychophysics and Just-Noticeable Difference. CMSC828D Report 4. USA: Department of Computer Science, University of Maryland.

14 BARTEN, P.G.J., 1999. Contrast sensitivity of the human eye and its effects on image quality. 1 edn. HV Press.

15 KIMPE, T. and TUYTSCHAEVER, T., 2007. Increasing the Number of Gray Shades in Medical Display Systems—How Much is Enough? *Journal of Digital Imaging*, 20(4), pp. 422-434

16 Δ or Delta is the Greek letter used to denote difference and E is the abbreviation of Empfindung, which is German for sensation.

17 JOHNSON, H., 2005. Mastering Digital Print. 2 edn. USA: Thomson Course Technology PTR.

5.4 Viewing conditions

5.4.1 Luminance and its effect on the observer

Luminance is the amount of visible light that comes to the eye from a surface. (Koschan, Abidi, 2008) ^[18] It will affect this JND scale and what the viewer can observe. Luminance is measured in candelas (cd/m^2). 1 candela is equivalent to the volume of light obtained from 1 candle. The level of candelas affects the JND values by increasing or decreasing the number of grey levels the human visual system (HVS) can perceive in one scene at a given time.

5.4.2 Illuminance and its effect on the observer

Illuminance will affect this JND scale and what the viewer can observe. Illuminance is measured in lux (lx) or lumens per square meter (lm/m^2). It is the total amount of visible light illuminating a point on a surface from all directions above the surface. (Koschan, Abidi, 2008) ^[19]

Both luminance and illuminance are important to know about because prints can be displayed as reflective (front lit) or transmissive (back lit) images. Both the illumination values will effect the viewing conditions.

5.5 Acceptable number of grey levels for the dynamic range of human vision

The dynamic range of the human eye is 11 log units grey levels, (10^{11} grey levels) – but not all in the one scene. In a single scene the human eye can only manage 3 log units (10^3 or 1000 grey levels). (Webb; Dorey, 1990) ^[20] In the range of 0-4000 cd/m^2 the human eye can distinguish approximately 1000 grey levels. In lower cd/m^2 the eye notices less JND than higher cd/m^2 – i.e. it becomes more difficult to identify changes in tone when there is less light for the observer to view the subject. (Tuytschaever, Kimpe 2007) ^[21]

Unlike prints which will have a fixed number of grey levels, electronic devices such as medical imaging input devices are capable of generating and sampling images that can capture 12-16 Bits of pixel information (or 4,096 – 65,536 shades of grey) (Kimpe;

18 KOSCHAN, A. and ABIDI, M., 2008. Digital Color Image Processing. 1 edn. USA & Canada: John Wiley & Sons.

19 KOSCHAN, A. and ABIDI, M., 2008. Digital Color Image Processing. 1 edn. USA & Canada: John Wiley & Sons.

20 WEBB, R.H. and DOREY, C.K., 1990. The Pixelated Image. In: J.B. PAWLEY, ed, Handbook of biological confocal microscopy. Rev. Ed edn. Plenum Press, pp. 41-51

21 KIMPE, T. and TUYTSCHAEVER, T., 2007. Increasing the Number of Gray Shades in Medical Display Systems—How Much is Enough?

Tuytschaver, 2007).^[22] The displays that output the images can display images of up to and just over 1024 grey levels (or 10bits of information) to the human observer. Trained medical professionals are capable of identifying between 800 – 1000 JNDs within a narrow luminance range (Matthijs, 2003)^[23]. These displays are in the range of 0.8cd/m² - 600cd/m² while over 1000 levels are available only 720 grey levels fall within the JND range for a human observer (Kimpe; Tuytschaver, 2007).^[24] Higher end displays are capable of displaying in the luminance range of 0.5cd/m² – 2000cd/m², yet in absolutely ideal conditions the viewer can only realistically expect to view 870 grey levels which is just within the 10bit image capacity.

A typical commercial display device falls into a range of between 250cd/m² – 300cd/m² reducing the number of greys that it is able to display.

Technology is available to capture and display images up to 16 bits per channel. Medical diagnostic display devices that achieve 10 bit of grey data already go beyond the scope of the human visual system (Kimpe; Tuytschaver, 2007).^[25]

It is a logical assumption that prints produced with between 9 and 10 bits of information would be reaching the threshold of the human visual system.

5.6 Grey channels within colour digital images

5.6.1 Colour separations.

James Clerk Maxwell was working on both the theory of color and on the electromagnetic wave theory of light (Alschuler,2008)^[26]. In 1861 he published his idea and gave a lecture “*On the Theory of the Three Primary Colours*” before the Royal Institution, (London, May 17 British Journal of Photography)^[27] that three widely spaced points on a spectrum could be combined and by varying the brightness could make up virtually every colour we see, (Eder, 1978)^[28] Maxwell went further and stated that there are two different sets of primaries, one for light and one for painting. We now know these to be the additive and subtractive primaries, terms first used by Louis Ducos

22 KIMPE, T. and TUYTSCHAEVER, T., 2007. Increasing the Number of Gray Shades in Medical Display Systems— How Much is Enough? *Journal of Digital Imaging*, 20(4), pp. 422-434

23 MATTHIJS, P., 2003. *Grayscale resolution: How much is enough?* edn. Barco Medical.

24 KIMPE, T. and TUYTSCHAEVER, T., 2007. Increasing the Number of Gray Shades in Medical Display Systems— How Much is Enough? *Journal of Digital Imaging*, 20(4), pp. 422-434

25 KIMPE, T. and TUYTSCHAEVER, T., 2007. Increasing the Number of Gray Shades in Medical Display Systems— How Much is Enough? *Journal of Digital Imaging*, 20(4), pp. 422-434

26 HANNAVY, J., ed, 2008. *Encyclopedia of Nineteenth-Century Photography*. 1 edn. USA: Routledge.

27 MAXWELL, J.C 1861. May 17, *British Journal of Photography*.

28 EDER, J.M., 1978. *History of Photography*. 4 edn. USA: Dover.

du Hauron in his development of colour photographic printing (Alschuler; Hannavey, 2008). ^[29] The additive primaries, red, green, and blue are the primary colours of light. When these are added together in equal proportions we see white. The subtractive primaries, cyan, magenta, and yellow are the primary colours used in painting and later printing. When the subtractive primaries are added together we see black and when subtracted produce white (ie the colour of the page). (Note that cyan and magenta are not the traditional primaries of painting but are closely related). (Benson, 2008) ^[30] Maxwell's discovery was further developed by Frederick Ives through the use of Fox Talbot's half-tone screen. This allowed for a colour image to be broken down into separations and printed as a series of lines and dots. When viewed at a distance they would appear to be the colour image.

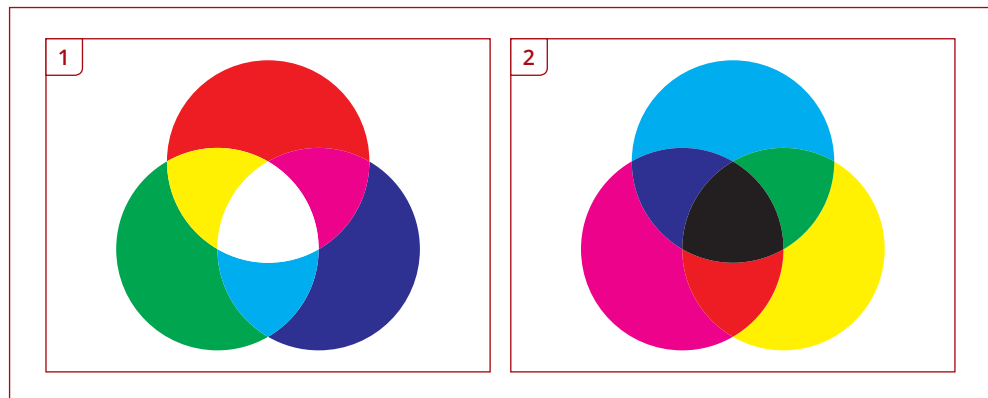

Figure 5.1 1) Additive primary colours for light 2) Subtractive colours for ink

While cyan, magenta, and yellow should give the appearance of black, the limitations of printing inks are not dense enough to do so black was added as its own separation in printing. It was given the abbreviation of K to avoid confusion with blue. The K is for keyline as black was used to add keyline details in woodblock printing. The dyes used in colour photography did not have this problem. This breakdown of colour images into CMYK half-tone separations is still the main method of conversion today.

5.6.2 Digital half-tones

In print, half-tone screening was developed in response to the market demands for multi-channel printing technologies. Half-tone printing screens can achieve a higher quality of detail by using a higher screen frequency, or lines per inch (lpi) to gain improvements. Resolution within digital technology by comparison mirrors this by increasing its pixels per inch (ppi) on screen and in inkjet technologies this is further

²⁹ HANNAVEY, J., ed, 2008. Encyclopedia of Nineteenth-Century Photography. 1 edn. USA: Routledge.

³⁰ BENSON, R.V., The printed picture. New York: Museum of Modern Art: c2008.

improved by decreasing the ink drop size to increase the number of dots per inch (dpi) that can be printed (Wende, 2010).^[31] This halftone method is usually AM or FM screening, an illustration showing the difference between the two is illustrated below.

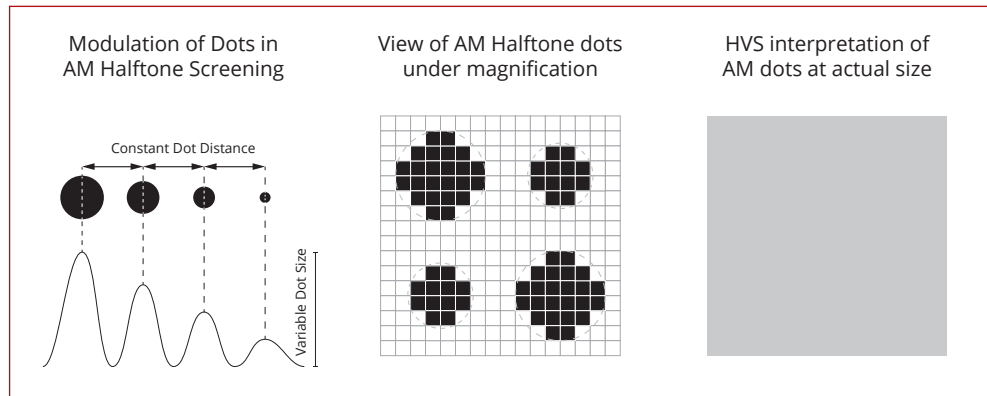

Figure 5.2 Example of AM Digital Halftone which mirrors print halftone

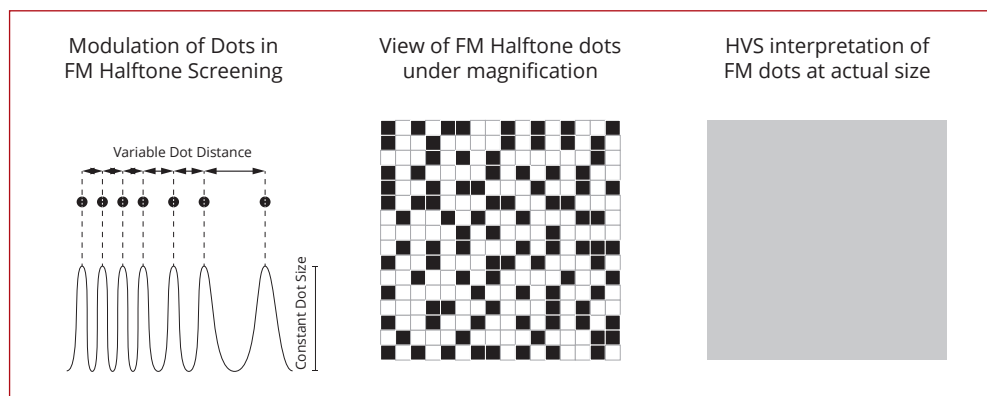

Figure 5.3 Example of half-tone screening in print

A general response to inkjet printed artworks is their lack of texture and ubiquitous surface quality. The image is flat and homogenous. Even with modern technology print gamuts are still restricted when using 8 bit CMYK conversion and further clipped or reduced when the half-tones of an image are reproduced by half-tone screening (Wende 2010)^[32]. Interference patterns can also occur causing artefacts within the printed artwork when the halftone grid is not aligned correctly or when trying to print heavily patterned background. Moiré interference patterns or rosettes are a problem

³¹ WENDE, A.V.D., 2010. Innovative Printmaking.

³² (Wende 2010) Pp 108

in colour half-tone printing.

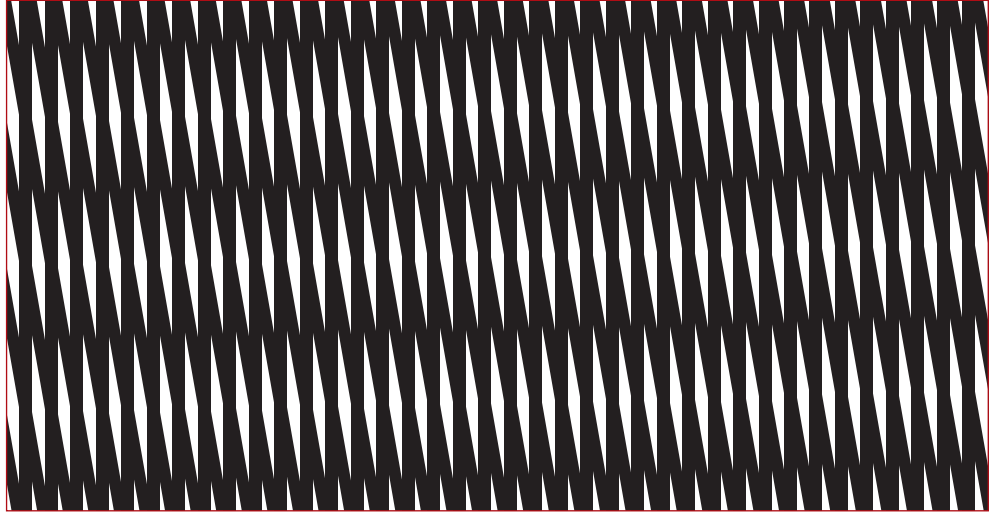

Figure 5.4 Example of an interference pattern in one colour

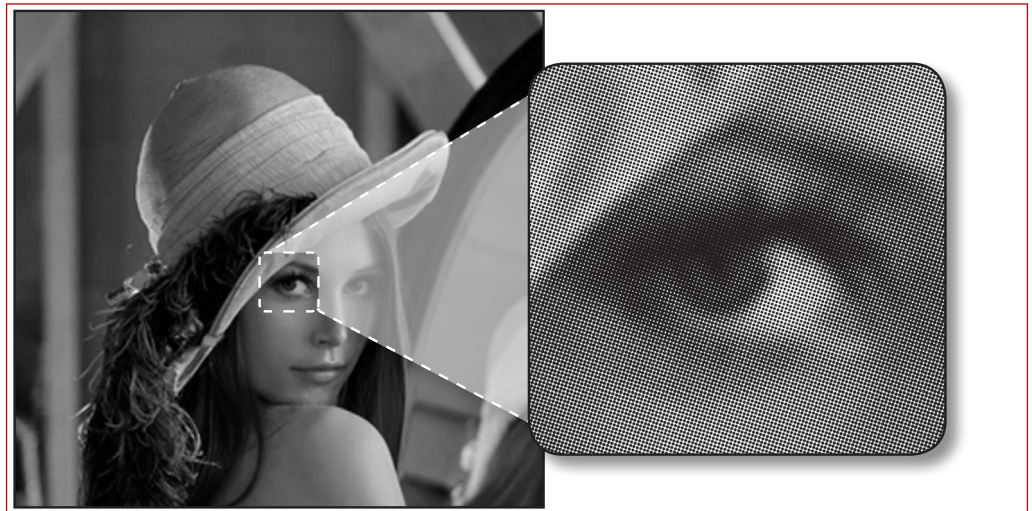

Figure 5.5 Example of AM Digital halftoning which is similar to traditional half-toning. (Image: Archival Playboy Material. Used with permission. All rights reserved).

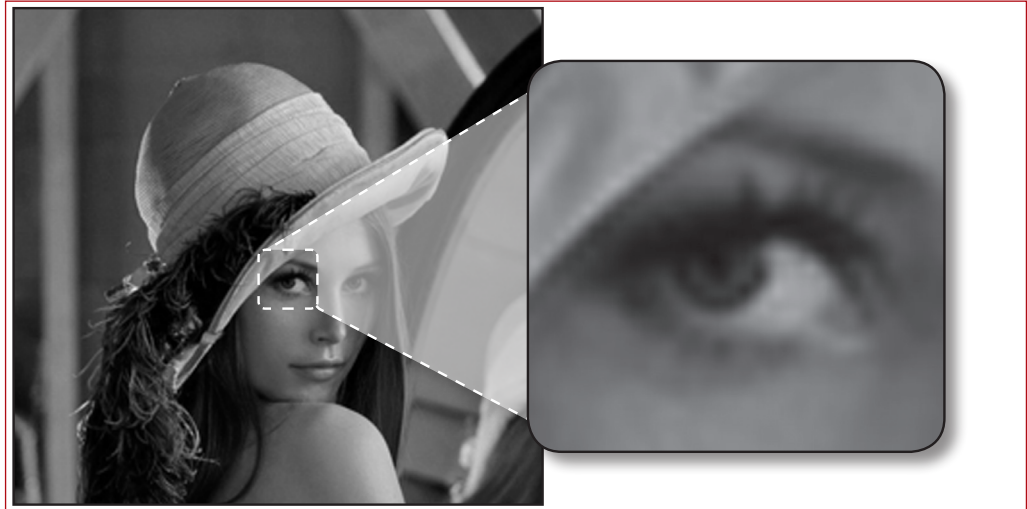

Figure 5.6 Example of continuous tone appearance replicating a silver particle reticulation in photographic prints. It aims to give a more continuous tone appearance as it generates a stochastic “random” pattern in print (Image: Archival Playboy Material. Used with permission. All rights reserved).

5.7 24 bit and 32 bit images

Colour digital images are sometimes called 24-bit RGB and 32-bit CMYK images. This is referring to whether the image is screen based (RGB) or print based (CMYK). Each of the primary colours (RGB or CMYK) is assigned its own individual colour channel or separation. Each separation contains all of the tonal information needed for that primary colour. Each separation contains 8-bits or 256 levels of greyscale information. The 3 RGB channels contain 24 bits (3 x 8-bits) of information, likewise the 4 CMYK channels contain 32-bits of information (4 x 8 bits). (Johnson, 2005) ^[33] As each separation consists of one 8-bit greyscale image it means that digital images contain no actual colour. It is only when the image is output that “colour” is introduced as a separate frequency of light or printing ink. When all or the output separations are viewed simultaneously, the image appears to be in full colour. It is the translation of this greyscale tone information to a physical height that is of importance to this study as it allows for the production of a continuous tone colour image.

33 JOHNSON, H., 2005. *Mastering Digital Print*. 2 edn. USA: Thomson Course Technology PTR.

5.8 Generating a 3 dimensional relief model through spatial and tonal resolution.

This research produces image separations with the information available in the the spatial and tonal resolution of a digital image. It uses these separations to produce a 3 dimensional model. The model is a digital representation of a Woodbutytype printing plate. The spatial resolution is used to generate the x and y co-ordinates or the width and height dimensions of the model, and the tonal resolution of each pixel is used to generate the z co-ordinate or the depth dimensions of the 3D model. The printing plate can then be produced through either subtractive manufacturing (SM) by CNC milling or additive manufacturing (AM) by 3D printing processes.

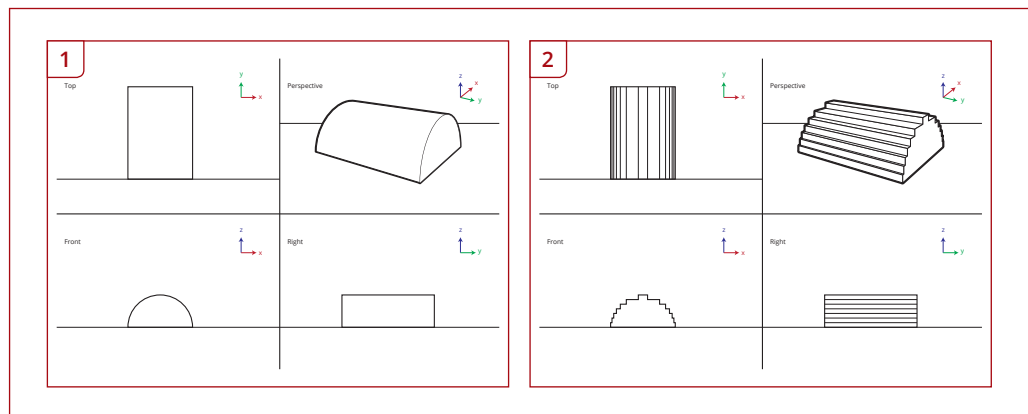

Figure 5.7 1) Source object 2) Digital sample

5.8.1 Greyscale height fields and bit depth

The printing plates generated from within this research will be manufactured by translating a 3 dimensional height field model and outputting the file by CNC or 3D printing.

The premise for this works on the principle that a standard 8 bit greyscale image is created with a maximum 256 shades of grey available (Webster, 2004).^[34] Each pixel is assigned a grey value which translates as a Cartesian co-ordinate in a 3 dimensional space. All of these co-ordinates produce a 3D model of the printing plate.

34 WEBSTER, M.A., 2004. Adaptation and subjective image quality. *Journal of Vision*, 4(11), pp. 4-4

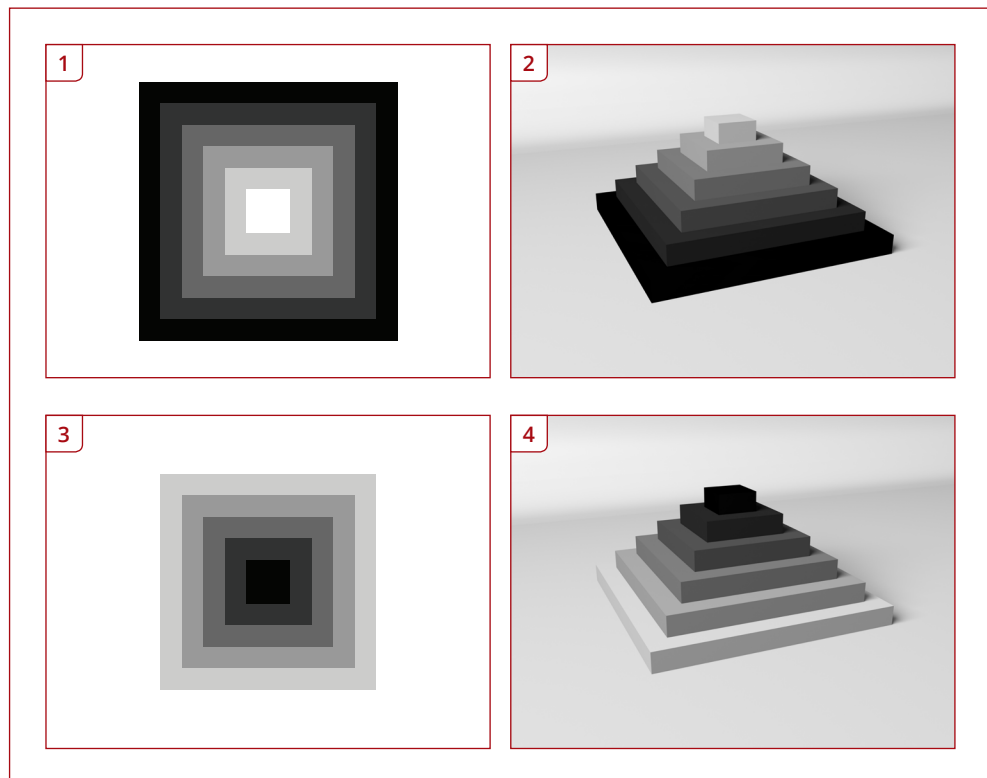

Figure 5.8 Grey tonal values assigned a Cartesian co-ordinate and viewed in a 3D space

CNC milling uses the computing language G-Code which connects a series of co-ordinates within the 3D model together and plots a tool path for the cutting tool to follow. Through the movement of the cutting tool along the path material is removed producing the printing plate in the process. (Thompson, 2007) ^[35].

Two different methods were used to produce the 3D printed plates. One process produces a layered print and the other method produces a layer-less or continuous print. Both processes begin in the same way with the 3D model being processed and sliced into layers. Depending how the layers are exposed to a photosensitive polymer will determine the type of print, this is explained further in 5.9

5.8.2 Subtractive manufacturing or CNC milling

Subtractive manufacturing is the making of objects by removing of material (for example, milling, drilling, grinding, carving, etc.) from a bulk solid to leave a desired

35 THOMPSON, R., 2007. Manufacturing processes for design professionals. 1 edn. London: Thames & Hudson.

shape, as opposed to additive manufacturing (BSI ISO ASTM, 2015).^[36] CNC milling is used to produce printing plates through subtractive manufacturing in this research.

In generating the 3D model for CNC, the higher the grey value of the pixel the higher the value for physical depth that is assigned to it. I.e. the darker tones the larger the larger volume that will be cut away and removed.

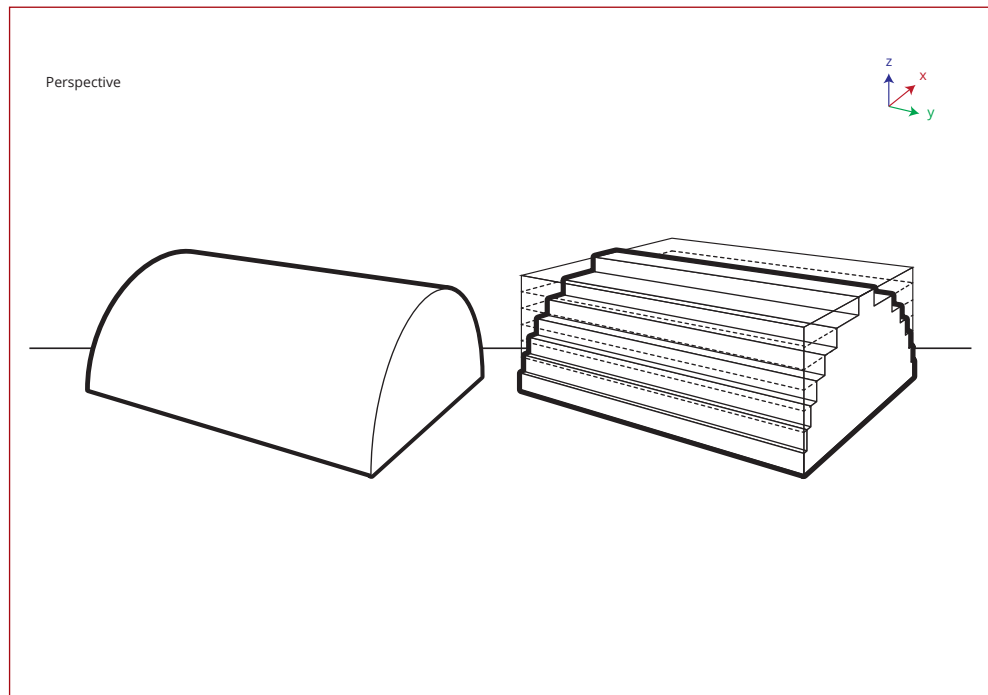

Figure 5.9 Original source image on the left and how the image is sampled on the right for the material to be removed from a solid block via CNC milling.

36 British Standards Institute, 2015. BS ISO / ASTM 52900:2015 Additive Manufacturing - General Principles-Terminology UK.

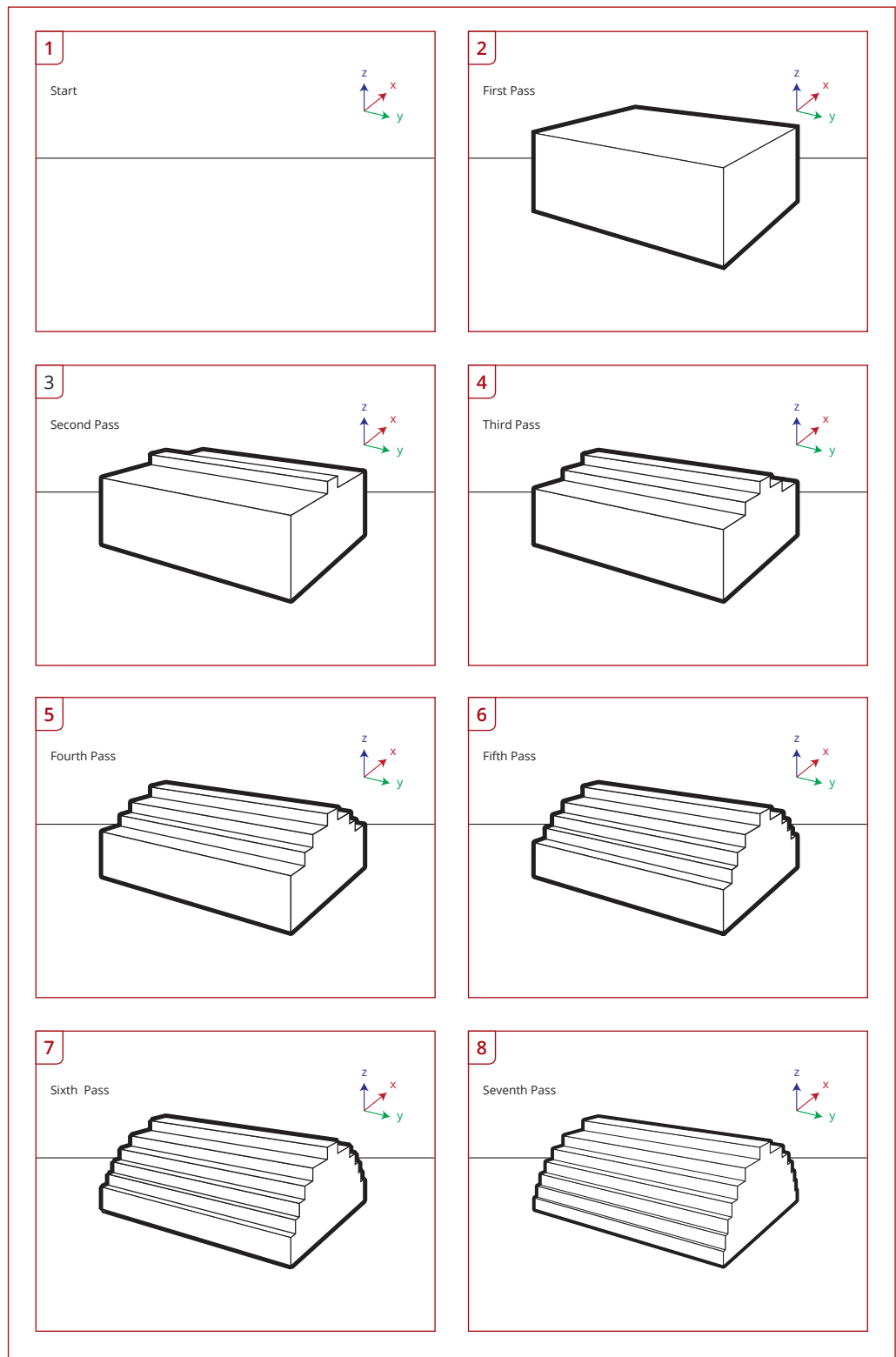

Figure 5.10 This diagram shows how through CNC milling layers of material are removed to reveal the final solid shape

5.8.3 Subtractive printing plate manufacturing by computer numerical control

Computer Numerical Control (CNC) is a technology driven variant of an earlier process called numerical control (NC). Modern CNC systems encompass a wide range of subtractive manufacturing processes including milling, routing, lathe, turning, drilling (boring) beveling, reaming, engraving, and cutting out. It is the most cost effective method of tool-making production up to approximately 1m³ (Thompson, 2007). ^[37]

CNC cutting can achieve a high quality of surface finish, and is able to produce virtually any solid complex shape that can be produced on CAD with a high degree of tolerance. Parts that need to be cut can be designed so that there is minimal excess waste material, extraction units can be used to collect dust for recycling. Virtually any material can be used but production can be slow and materials with low melting temperatures slow the process down further. Due to the slow production speeds it is best suited to one off pieces (Lefteri,2012) . ^[38]

5.8.4 CNC Resolution

Throughout the empirical research of this thesis, the Roland MDX-540 was used. It is a three-axis modeling machine capable of a resolution of 1μ when in NC mode (Roland DG, 2008) ^[39].

In a similar concept of dot size in half-tone printing, the cutting tool diameter size in CNC cutting determines the fineness of the milled image or in this instance the fidelity of the printing plate.

5.8.5 Cutting, material removal and surface finish

The amount of material that is removed in each pass of the cutting tool is known as the depth or width of cut. This is determined on how far the centre of the cutting tool moves on each pass. Width of cut is also known as the stepover distance. It is better to calculate the stepover distance rather than use automatic features (Smid, 2003) ^[40]. Using a calculated distance ensures that the stepovers are equal and consistent throughout the cutting.

The radius of the cutting tool will generate scallops as it cuts the material. Wide stepovers will generate larger scallops, or high cusp heights, and generally produce a rougher surface finish. Narrow stepovers will generate smaller scallops or low

³⁷ THOMPSON, R., 2007. Manufacturing processes for design professionals. 1 edn. London: Thames & Hudson.

³⁸ LEFTERI, C., 2012. Making it : manufacturing techniques for product design. 2 edn. London: Laurence King.

³⁹ ROLAND DG COPORATION, 2006-2008. Modela Pro 2 MDX-540s MDX-540 User's Manual. Roland DG Corporation.

⁴⁰ SMID, P., 2003. CNC Programming Handbook, A Comprehensive Guide to Practical CNC Programming. 2 edn. United States of America: Industrial Press Inc.

cusps and produce a smoother surface finish. For pocketing cuts (explained in Appendix 5) the cutter diameter is typically about 1.5 times larger than the intended width of cut. (Smid, 2003)^[41]

5.8.6 Stepmover Amount Calculation

The stepover in pocketing is also referred to as the width of cut. When pocketing, it is recommended that a specific value is calculated given as opposed to a percentage of the cutting tool as it will ensure an equal value for all cuts. (Smid, 2003)^[42]

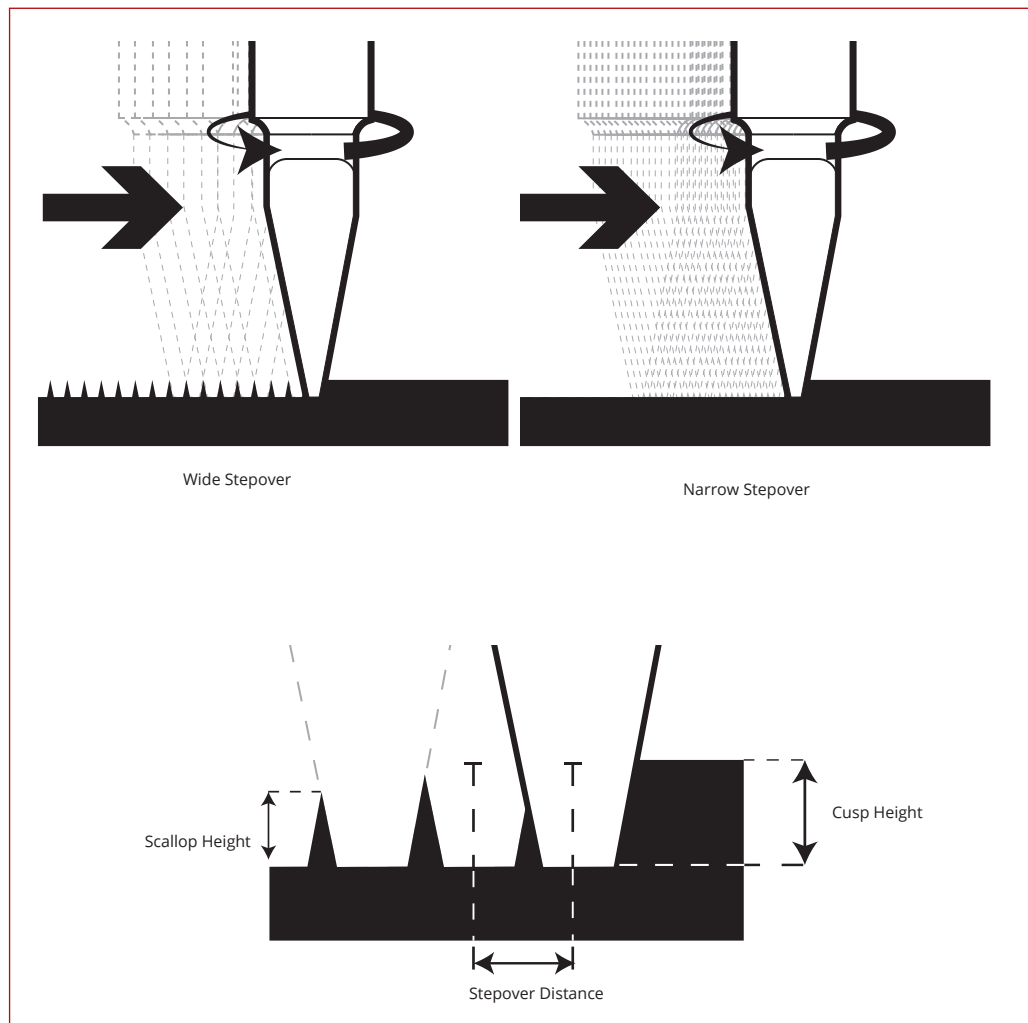

Figure 5.11 Demonstration of step-over, scallop, and cusp.

⁴¹ SMID, P., 2003. CNC Programming Handbook, A Comprehensive Guide to Practical CNC Programming. 2 edn. United States of America: Industrial Press Inc.

⁴² SMID, P., 2003. CNC Programming Handbook, A Comprehensive Guide to Practical CNC Programming. 2 edn. United States of America: Industrial Press Inc.

The height field once generated is output through a CNC milling machine. The height that is allocated to the shades of grey with the 3D software control the contour depth of the CNC milling machine's cutting tool. The cutting depth is constrained by a maximum and minimum setting controlled by the operator. A tone value of 255 (white) will move the depth of the cutting tool to 0mm, i.e. it will not cut the plate substrate. A tone value of 0 (black) will move the cutting tool to a desired depth for example 1mm, i.e. it will cut the plate substrate. The grey scale values control the depths between the maximum and minimum height values.

The pixels in a digital image do not have a physical size until they are assigned one by either a half-tone dot when printed or a cutting tool size when milled. The printed dot size is smaller than the cutting tool of the CNC mill. This would give the impression that the dot is of a finer resolution however while the dot is fixed the cutting tool size is dynamic as it moves along the z axis between the points of the x and y axes. This movement between Cartesian co-ordinates by the cutting tool creates sub-grey levels increasing the tonal range of the image.

5.9 3D print technology and additive manufacturing

"Additive manufacturing is the process of joining materials to make objects from 3D model data, usually layer upon layer, as opposed to subtractive manufacturing methodologies" (BSI ISO ASTM, 2015). ^[43]

There are several publications available that discuss additive manufacturing or 3D printing technology in great detail (Hoskins, 2013) ^[44] (Lipson, Kurman, 2013)^[45]. This section is only going to provide a small overview to introduce the main categories of 3D printing and give a very basic description of each process.

There are many different kinds of processes that fall under this blanket term for the technology. 3D printing generally falls into two categories. Once the 3D model has been processed, the machine either selectively deposits or binds material to produce the model. Typically each process involves slicing the 3D model into layers or G-Code that is then "printed".

43 British Standards Institute, 2015. BS ISO / ASTM 52900:2015 Additive Manufacturing - General Principles-Terminology UK.

44 HOSKINS, S., 2013. 3D Printing for Artists, Designers and Makers. 1 edn. London: Bloomsbury Publishing Plc.

45 LIPSON, H. and KURMAN, M., 2013. Fabricated. The New World of 3D Printing. 1 edn. USA: John Wiley & Sons, Inc.

5.9.1 Fused Deposition Modelling (FDM)

This is the most common 3D print process. Over time it has become open-source and in comparison to other 3D printing methods it is inexpensive. It uses an XYZ printing platform or print head to deposit a thin strand of a thermoplastic which has been melted and deposited through a nozzle. This process translates the model into G-Code allowing for a continual deposit of material.

5.9.2 Laser Engineered Net Shaping (LENS)

This method sprays a jet of powdered metal such as titanium through a laser so that a deposition is built up to form the object.

5.9.3 Laminated Object Manufacturing (LOM)

This process involves the lamination of thin layers of substrate. Layers are deposited and cut with a laser or knife. Once all of the layers are in place they are pressed and laminated to form the final printed object.

5.9.4 Photo-polymeric inkjet deposition (Polyjet Printing)

Polyjet printers straddle both categories as they deposit a UV curable material similar to an inkjet printer and then cure it with a UV light. This process can have multiple printheads allowing for different materials with different properties to be printed at the same time.

5.9.5 Stereolithography (SLA)

A tank of UV sensitive photopolymer that cures when exposed to UV light is exposed to a moving laser beam that traces the outline of each layer. As the laser passes it cures the material.

5.9.6 Direct Metal Laser Sintering (DMLS) / Laser Sintering (LS)

Very similar to SLA this process uses lasers and a tank of powder. Where the laser traces over the powder, it melts and fuses it together. In between each layer the tank moves down and fresh material is spread on top.

5.9.7 Three Dimensional Printing (3DP) / Powder binder 3D printing

Similar to LS this process still uses a tank of powdered material where it inkjets or sprays a binder material onto the tank. In between each layer the tank moves down and fresh material is spread on top.

5.9.8 Digital Light Processing (DLP)

This process is very similar to SLA. A tank of UV curable photopolymer is exposed to a silhouette of the image through a projector. As the silhouette changes the build moves up out of the resin allowing for a continual movement in the Z axis of the print which removes or reduces the layering steps often associated with 3D printing.

In this study the 3D printing processes that are utilised are photo-polymeric inkjet deposition and digital light processing.

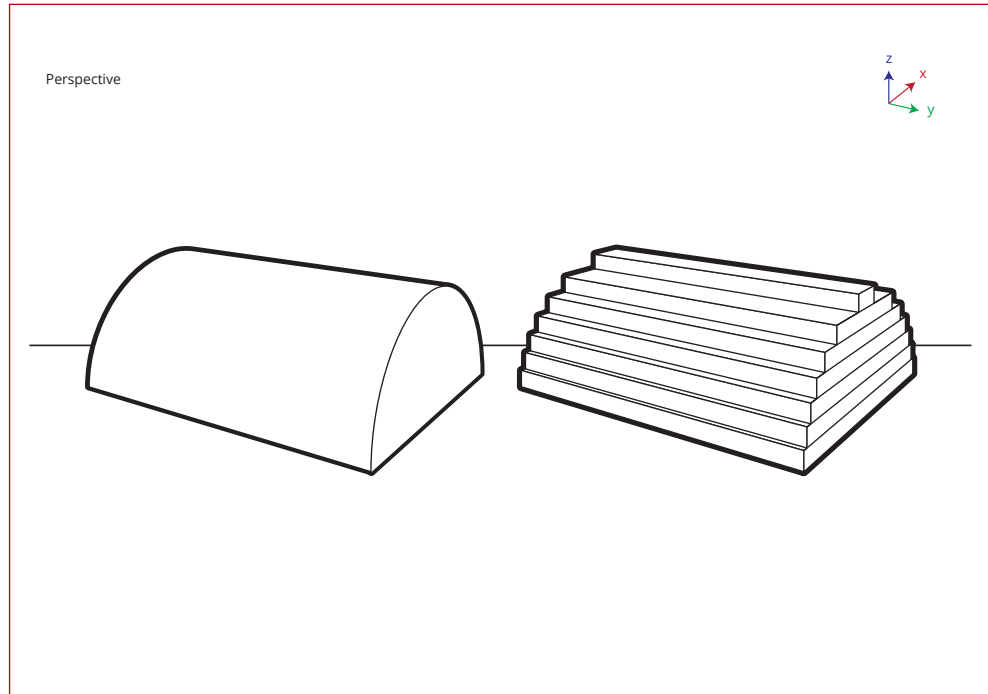

Figure 5.12 Original source image on the left and how the image is sampled on the right for the material to be built up in layers via 3D printing / additive manufacturing.

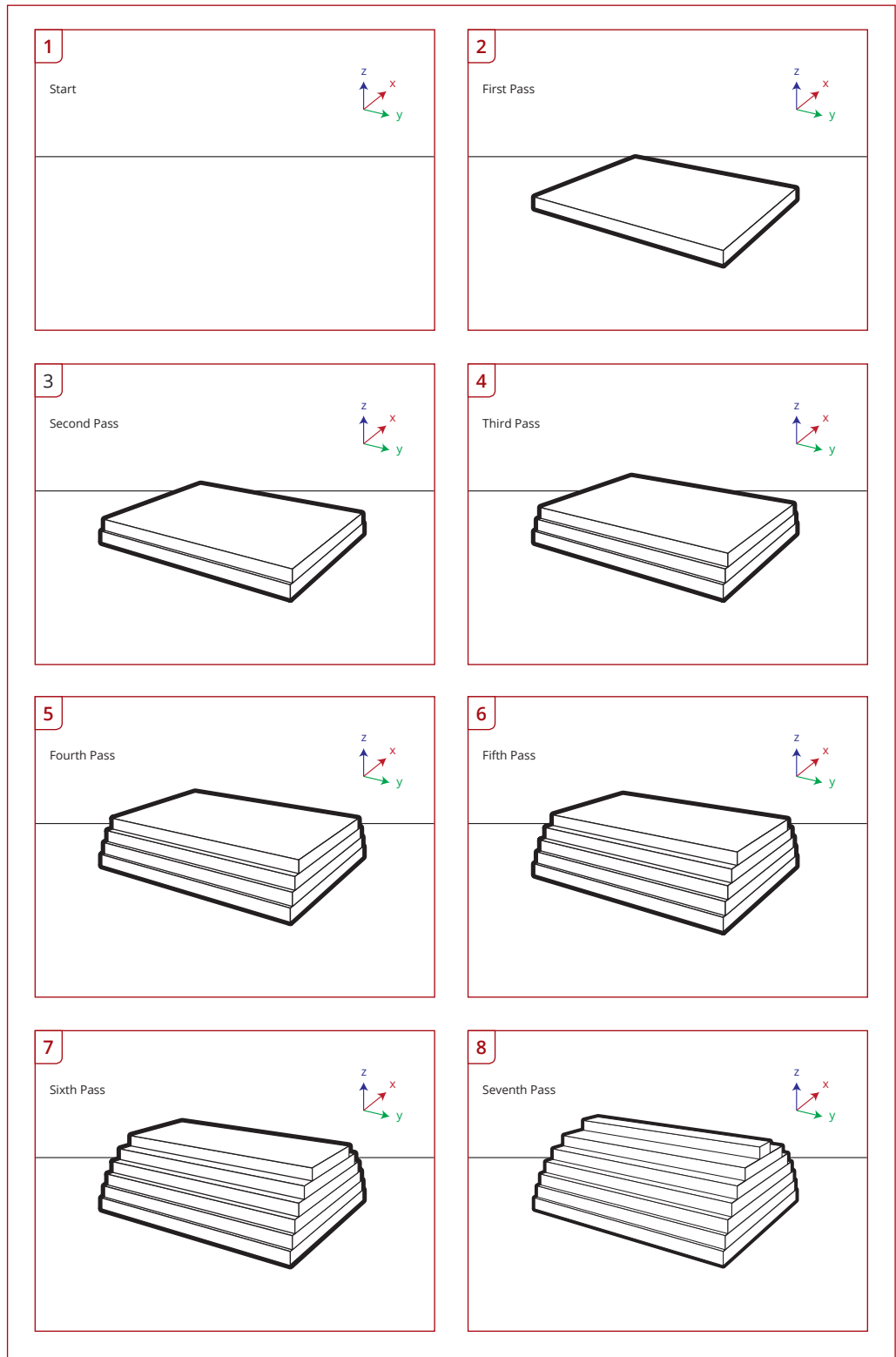

Figure 5.13 This diagram shows how through additive manufacturing layers of material are added to reveal the final solid shape via 3D printing.

5.10 Actual losses and perceptual gains

5.10.1 Tool smoothing, tonal half-steps and sub-pixel resolution detail.

The width and depth of the CNC cut determines the coarseness of the surface finish. In achieving a higher surface finish, the pixel dimensions of the bitmap image will provide a higher resolution in the x and y co-ordinates. A large bit depth combined with total depth of cut will increase the sample rate of the cutter. The step-over of the cutting tool path will apply a smoothing effect on the finer image details similar to a Gaussian blur or feathering of the image due to the cutting tool removing material on the return pass. The radius of the cutting tool and the step-over value will determine the severity of this smoothing of the image detail. Widths of cut made by a cutting tool with a small radius and narrow step-over will produce finer results in comparison to cuts made by a cutting tool with a large radius and wide step-over. Due to the chamfered angle of the engraving tool used in these tests by the CNC it can be described that each transition between individual tones includes a transitional gradient of 7.5° between the each JND (based on the cutting tool that was used in my tests). This linear movement smooths out the tone increasing the overall tonal range albeit perceptually. While the XY motion of the CNC is stepped the softening of the image on the z axis provides additional tonal information that is not there in the 256 greyscale source image as it moves along the vectoral curve.

5.10.2 Semi-continuous tone

The results that are discussed within this study are from prints that are semi-continuous tone. The digital image needed to produce the CNC milled printing plates contains tonal restrictions caused by the grey levels available in digital file's bit-depth. While this limitation cannot be completely removed the step-over motion of the CNC cutting tool as it moves from point to point along the a z-axis smooths the appearance of aliasing artefacts caused by the restricted number of grey levels along the x and y axes that would have been transferred to the final print.

5.10.3 Perceptual information gains through relief surfaces

It has been observed by Heynderickx and Kaptein (2009) ^[46] that images that contain a 3D relief or a slight relief in appearance, even those that are stereoscopic in nature are perceived to contain more resolution and detail in appearance to the observer than the same image produced in a flat and homogenous printing method with a higher spatial resolution and with more actual detail. It appears that the human observer prefers images and artefacts that contain a physical structure. We use the change in illumination and tonality to amend the image to gain a higher level of interpretation. Our minds fill in the blanks and may appear to artificially generate more information than there actually is.

46 HEYNDERICKX, I. and KAPTEIN, R., 2009. Proc. of SPIE-IS&T Electronic Imaging, Image Quality and System Performance VI, S.P. FARNAND and F. GAYKEMA, eds. In: Perception of detail in 3D images, 2009 2009, SPIE

5.10.4 Perceptual information gains through viewing distance

The overall image resolution is relative to the size and viewing distance of the image. The size and viewing distance has an effect on the perceived detail of the the overall image and this provides the illusion of continuous tone imaging that is generated by halftone screening and bitdepth information. As Boulder Nonlinear Systems (2001) ^[47] demonstrates a 1 bit digital image that contains only 100% black and 100% white information can have the appearance of an 8-bit image containing 256 shades of grey by decreasing the pixel dimension. (See Figure 5.14)

This is also the case for prints produced via half-toning processes. Print quality is dependent on viewing distance in relation to size of dot. Both printed and in-device viewing, the appearance of detail can be perceived to be higher than the resolution actually permits simply by adjusting the dpi / ppi or viewing distance.

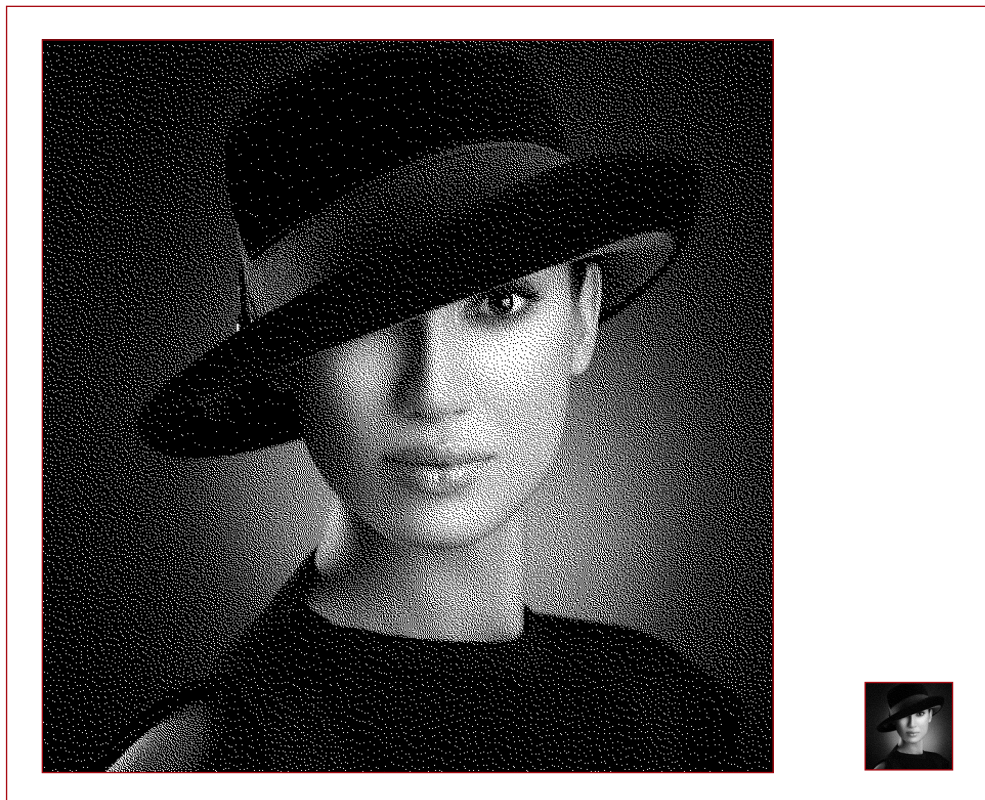

Figure 5.14 The same 1 bit image presented enlarged and reduced in size to represent viewing at a distance where it appears to contain the information of an 8-bit file.

Image credit: istock.com/ gilaxia

⁴⁷ BOULDER NONLINEAR SYSTEMS, 2001. Image Resolution Vs. Bit-Depth. The perceptual trade-off in a two dimensional image array. White Paper. USA: Boulder Nonlinear systems.

5.11 Definition of Colour and the subjectivity of testing

Biggam (2012)^[48] defines colour as having four principal constituent parts: hue, saturation, tone and brightness.

Hue refers to the spectrum of visible light, parts of which, according to their wavelength or frequency, are perceived by humans to differ from others.

Saturation refers to the purity of a hue in relation to the amount of grey it is perceived to contain.

Tone refers to the admixture of white or black with a hue, creating a range which runs from pale at one end to dark at the other (in which no white is perceived).

Brightness is concerned with the amount of light reaching the eye, but as the nature and sources of such light are varied, the colour could be absorbing light, reflecting light or emitting light itself.

The digital imaging colour pipeline is designed to reproduce a visually pleasing and reasonably accurate colour image. Steps within the pipeline are intended to mimic the human visual system. Under different lighting conditions, the same object can be perceived differently. (Xiao, Farrelb, DiCarloc & Wandella, 2003)^[49]

This will cause either an instance where colour constancy occurs and the print looks correct, or a metamer and the print looks incorrect. There is currently no single colour management process or method that provides predictable colour across every design and print scenario (O'Neill, Martin et al, 2008).^[50]

5.11.1 Colour constancy

When the same object, under different illuminations reflects different light spectrums back to the human observer a colour ambiguity can occur. The human visual system typically resolves this ambiguity, providing a consistent representation of the surrounding colours, meaning that object colours tend to appear the same even when illumination conditions change. This is known as colour constancy. (Brainard, Longère et al, 2006)^[51]

48 BIGGAM, C.P., 2012. *The Semantics of Colour. A Historical Approach*. 1 edn. USA: Cambridge University Press.

49 XIAO, F., FARRELLB, J.E., DICARLOC, J.M. and WANDELLA, B.A., 2003. Preferred Color Spaces for White Balancing. *Imaging*, 5017

50 O'NEILL, J., MARTIN, D., COLOMBINO, T., ROULLAND, F. and WILLAMOWSKI, J., 2008. Colour Management is a Socio-technical Problem. *Proceedings on the 2008 ACM Conference on Computer Supported Cooperative Work*, November 8-12, pp. 599-608

51 BRAINARD, D.H., LONGÈRE, P., DELAHUNT, P.B., FREEMAN, W.T., KRAFT, J.M. and XIAO, B., 2006. Bayesian model of human color constancy.

5.11.2 Metamerisms

In addition to constancy a colour phenomenon known as metamerism can also occur with a change in illumination. A metamer is when two different color objects appear to have the same color to an observer under one set of illumination conditions (metameric match) but look different under another light source (metameric mismatch). (Johnson, 2005) ^[52]

5.11.3 Colour checker

The Gretag MacBeth colour checker is synonymous with the graphic arts and printing. The colour checker chart was developed in 1976 (McCamy et al, 1976) ^[53] to aid the comparison between image and object through spectral measurements. Colours were selected to try and match natural objects but exact matches were not expected. The colours contained in it were yet another example of subjectively chosen and subjectively assessed metrics (see ‘standard colorimetric observer’). McCamy concludes that compromises are necessary and that often one person may prefer different processes for different purposes. The same colours cannot be rendered the same by different processes and practical limitations of such processes make perfect color reproduction virtually impossible. While the chart is a useful analytical tool final judgments should always be based on actual use of processes.

5.11.4 Accuracy and fidelity

Colour accuracy is not the best metric for assessing the quality of prints. In industry colour is managed through working processes that are often based on process feedback loops, where the overarching quality metric is fidelity not accuracy (Beretta, 2012)^[54] At several points in the printing process there are subjective quality control checks. These are all dependent on the skill of the technician, (Verikas, 2011)^[55] and through working with their client they will know if it is subjectively meets their needs.

A trained colour technician are highly skilled and can distinguish about 10 million colours, however this is subjective and highly personable. The main case of print rejection is when prints do not meet human observer expectations (Temponi, Farb & Corley, 1999). ^[56]

⁵² JOHNSON, H., 2005. Mastering Digital Print. 2 edn. USA: Thomson Course Technology PTR.

⁵³ MCCAMY, C.S., MARCUS, H. and DAVIDSON, J.G., 1976. A Color-Rendition Chart. *Journal of Applied Photographic Engineering*, 2(3, Summer), pp. 95-99

⁵⁴ BERETTA, G.B., HOARAU, E., KOTHARI, S., LIN, I. and ZENG, J., 2012. Assessing color reproduction tolerances in commercial print workflow. *Color Imaging SPIE 8292*, XVII, pp. 1-14

⁵⁵ VERIKAS, A., LUNDSTRÖM, J., BACAUSKIENE, M. and GELZINIS, A., 2011. Advances in computational intelligence-based print quality assessment and control in offset colour printing. *Expert Systems with Applications*, 38, pp. 13441-13447

⁵⁶ (Temponi, Farid Derisavi et al. 1999)

Just as perception varies between colour print technicians, it is difficult to print within the framework of ISO and similar standardising bodies due to the large number of variables that need to be controlled. (Lundström, 2012)^[57]. Colour management either restricts the work activities of the printer or forces workarounds to meet the needs of the client (O'Neill, Martin et al, 2008).^[58] ICC colour management requires strict, co-ordinated and knowledgeable adherence to sets of procedures and protocols by people across a document's entire lifecycle, from its conception to its production (O'Neill, Martin et al, 2008).^[59] In many situations the most desirable or preferred colour reproduction is not necessarily the most faithful, and colour memory may be a factor in this (Lee, 2005).^[60]

5.11.5 Colour memory

Personal colour preference interferes with our colour memory and tends to produce a preference that is always over saturated and based on our ideal representation of objects. This produces an almost impossible goal of being able to produce all colours as we prefer to see them (Lee, 2005).^[61]

5.12 Colour management

Colour management is a technical approach to achieve colour constancy, although it is rarely used as intended. (O'Neill, Martin et al, 2008)^[62] CIEDE 2000 is regarded as being the best uniform colour difference model coinciding with human subjective visual perception (Yang, Ming, & Yu, 2012).^[63] Mathematically accurate images do not mean a good quality print, and quite often artistic images such as photographs are mathematically unnatural and contain extreme exaggerations of hue, tone, saturation and luminance, but human observers relate to them, making them more desirable, even though they are technically incorrect (Lee, 2005).^[64]

57 LUNDSTRÖM, J., VERIKAS, A., TULLANDER, E. and LARSSON, B., 2013. Assessing, exploring, and monitoring quality of offset colour prints. *Journal of the International Measurement Confederation (IMEKO)*, 46, pp. 1427-1441

58 O'NEILL, J., MARTIN, D., COLOMBINO, T., ROULLAND, F. and WILLAMOWSKI, J., 2008. Colour Management is a Socio-technical Problem.

59 O'NEILL, J., MARTIN, D., COLOMBINO, T., ROULLAND, F. and WILLAMOWSKI, J., 2008. Colour Management is a Socio-technical Problem. *Proceedings on the 2008 ACM Conference on Computer Supported Cooperative Work*, November 8-12, pp. 599-608

60 LEE, H., 2005. *Color Imaging Science*. 1 edn. UK: Cambridge University Press.

61 LEE, H., 2005. *Color Imaging Science*. 1 edn. UK: Cambridge University Press.

62 O'NEILL, J., MARTIN, D., COLOMBINO, T., ROULLAND, F. and WILLAMOWSKI, J., 2008. Colour Management is a Socio-technical Problem.

63 YANG, Y., MING, J. and YU, N., 2012. Color Image Quality Assessment Based on CIEDE2000. *Advances in Multimedia*, 2012(2012),

64 LEE, H., 2005. *Color Imaging Science*. 1 edn. UK: Cambridge University Press.

5.12.1 Standard colorimetric observer

Colour imaging scientists and engineers describe colour using precise 3-dimensional colorimetric designations as a set of spatial co-ordinates, such as CIE Lab (which is most commonly represented as Adobe 1998), CIEDE 2000 etc. These co-ordinates are referred to as “device independent colorimetric specifications”, and are often based on a set of values determined by “the standard colorimetric observer”. (Woolfe, 2007) ^[65]

The standard colorimetric observer was determined by Guild and Wright (CIE 1924). This colour specification was generated by averaging results obtained from two groups of ten and seven human participants as they observed changes in light. (Lee, 2005) ^[66]

The difficulty of averaged results is that they are based on individual sensitivities, and not everyone has the same perception of colour. Guild and Wright’s data was used to formulate CIE 1931, which in turn was used to derive other colour spaces such as CIE XYZ. Today CIE XYZ and CIE Lab systems are commonly used colourimetric specifications. (Woolfe, 2007) ^[67] Furthermore, certain uses of calibration using the CIE Lab system requires subjective input from a human observer (Lee, 2005). ^[68]

Lee, (2005) I feel makes a very interesting point that in obtaining measured results, accuracy and precision are of great concern. Accuracy relates to how close the measured value is to the true value, and precision is how reproducible obtaining the measurement is. When a measurement is taken the difference between this and the true value is known as an “error”. In most instances both values are not known and the error value is obtained by repeating the measurements, and averaging the results.

While spectral devices are calibrated before use in colour management, the values used to do this are based on averaged results from standard colorimetric observers. Further to this Beretta, Hoarau, et al (2012) highlight that the accuracy of the calibration and the ICC profiles that are used are dependent on the skills and the tools used by the colour technician who created them. When error values are taken into consideration, if the average error is large we as observers will see this as a print of good quality as colour constancy will cause us to correct the image mentally. If the errors contained are small and in random directions we will notice these and perceive it to be incorrect and of poor quality. ^[69]

⁶⁵ WOOLFE, G., 2007. Natural Language Color Editing. Inter-Society Color Council 2008 Annual Meeting,

⁶⁶ LEE, H., 2005. Color Imaging Science. 1 edn. UK: Cambridge University Press.

⁶⁷ WOOLFE, G., 2007. Natural Language Color Editing.

⁶⁸ LEE, H., 2005. Color Imaging Science. 1 edn. UK: Cambridge University Press.

⁶⁹ BERETTA, G.B., HOARAU, E., KOTHARI, S., LIN, I. and ZENG, J., 2012. Assessing color reproduction tolerances in commercial print workflow.

While it is impossible to control every variable in the process, they can be reduced within known constraints. While colour accuracy is good to observe as a starting point, it is not critical and it must be noticed that colour quality is highly subjective. Printers tend to work with customers to achieve a standard that they prefer even if it is out of synchronisation with a production loop or process.

5.12.2 Colour science and mathematical measurement

We see colour because of a physical stimulus because of electromagnetic radiation in the visible region of the spectrum. This visible region is commonly called light. Visible region is specified as having a particular wavelength between $\lambda_{\min} = 360 \text{ nm}$ and $\lambda_{\max} = 830 \text{ nm}$. The radiation on this wavelength stimulates the retinal receptors in our eye, this causes the phenomenon of vision and the perception of colour. Colour in the physical world varies depending on the light stimulus. So that images can be reproduced on a device the stimulus must be recorded and translated from the additive colours of light to the subtractive colours of print. These colours can be mapped into a 3-dimensional set of co-ordinates within a colour space such as CIE XYZ or CIE LAB. In order for this translation to be mathematically accurate recording devices are used to record spectral information. Spectroradiometers record and sample optical radiation as a function of wavelengths. Spectrophotometers measure the spectral reflectance of an object. Colorimeters measure tristimuli values and record them within a 3D colour space. (Sharma, 2003)^[70] The information gathered by these spectral devices can then be used to calibrate, gamut map and profile colour imaging input and output devices to a set of known values as part of a colour management process chain.

5.12.3 Subjective qualitative testing

Ansel Adams reinforces this notion of having a starting point and adapting it to get the desired output. Describing it, that no matter how accurately perceived a photographic image is there is a large portion of subjective input by the photographer and how they feel and think the image should be captured. There may be certain amount of subjective correction to reduce or enhance the distortion caused by the lenses of the camera on the final image capture. There may also be a specific amount of subjective control as to how much light is used in the scene or for how long the image is exposed to create the snapshot. The captured image is then put through another subjective set of inputs as to how the image should be developed and printed. It would be impossible to control every variable within the creative processes for photography, graphic

70 Sharma, G., ed. (2003) Digital Color Imaging Handbook. USA: CRC Press.

industry and printing. Variables can be reduced but not all can be controlled. Adams book series *The Camera* (1980)^[71], *The Negative* (1981)^[72] and *The Print* (1983)^[73]

5.12.4 Initial and final quality assessment

Visual observation in colour science is a two-stage process: stimulus detection by the eye and interpretation in the brain. Current instruments can only perform the first stage, therefore the screening and training of observers is very important. (Beretta, Hoarau, et al 2012)^[74]. As colour preference is personal, training of observers can also introduce influence an additional bias on the decision making of quality metrics.

Usually the initial print assessments are visual and by human print operators. This perception is typically different for different operators. It is also difficult to print within the standards contained in ISO and similar documents (Lundström, Verikas & Larsson, 2012)^[75]

The ISO standards that colour management processes and tools are based on still insist that the final visual inspection is done by a trained human visual assessor. So much so that it is the first sentence of the introduction in ISO 3664:2009 *Graphic technology and photographic - Viewing conditions*

“While colour and density measurements play important roles in the control of colour reproduction, they cannot replace the human observer for final assessment of the quality of complex images.”^[76]

When you take this into account it is essentially stating that regardless of what the colour management is indicating, if it looks incorrect it is incorrect and if it looks correct it is correct.

71 Adams, A. (1980) *The Camera*. the New Ansel Adams Photography Series / Book 1. 1st ed. USA: Little, Brown and Company, Ltd.

72 Adams, A. (1981) *The Negative*. the New Ansel Adams Photography Series / Book 2. 1st ed. USA: Little, Brown and Company.

73 Adams, A. (1983) *The Print*. the New Ansel Adams Photography Series / Book 3. 1st ed. USA: Little, Brown and Company.

74 BERETTA, G.B., HOARAU, E., KOTHARI, S., LIN, I. and ZENG, J., 2012. Assessing color reproduction tolerances in commercial print workflow. *Color Imaging SPIE 8292*, XVII, pp. 1-14

75 LUNDSTRÖM, J., VERIKAS, A., TULLANDER, E. and LARSSON, B., 2013. Assessing, exploring, and monitoring quality of offset colour prints . *Journal of the International Measurement Confederation (IMEKO)*, 46, pp. 1427-1441

76 THE BRITISH STANDARDS INSTITUTION, 2010. *BS ISO 3664:2009. Graphic technology and photography — Viewing conditions* Incorporating corrigendum January 2010. 2 edn. BSI.

Beretta, Hoarau, et al (2012); states “In the end, colour prints are not bought and read by spectrophotometers but by humans, or “observers” in colour science parlance.^[77]

In the color reproduction of images of human subjects, the preferred skin color varies with race and it is usually more saturated and orange yellow than the real, average skin color. This preference also changes overtime where historically pale skin was a sign of wealth indicating you were not an outdoor manual labourer, whereas today a suntanned skin indicates the wealth of being able to sunbathe (Lee, 2005)^[78].

The fundamental is that ISO standards of colour measurement work within a defined / reduced colour gamut, such as SWOP where consistency of colour from one print to the next is obtained. In itself it is not an accurate tool for colour measurement.

77 BERETTA, G.B., HOARAU, E., KOTHARI, S., LIN, I. and ZENG, J., 2012. Assessing color reproduction tolerances in commercial print workflow.

78 LEE, H., 2005. Color Imaging Science. 1 edn. UK: Cambridge University Press.

5.13 Goethe's *steigerung* (gradual ascent) of colour.

In his 'Theory of Colours' (paragraphs 517 – 518) Goethe (1840)^[79] describes tonal and hue shifts through a process of intensification when the opacity of transparent mediums such as liquids is changed through adjusting their volume and when observed from above the colour shifts from light to dark. Likewise shadows that are cast onto and through the liquids also cause changes in the hue as well as the tone. This is the fundamental principle of how colour and tone is rendered in photoplastographic imaging. This principal can also be used to develop a colour mixing tool and hence is directly relevant to this study.

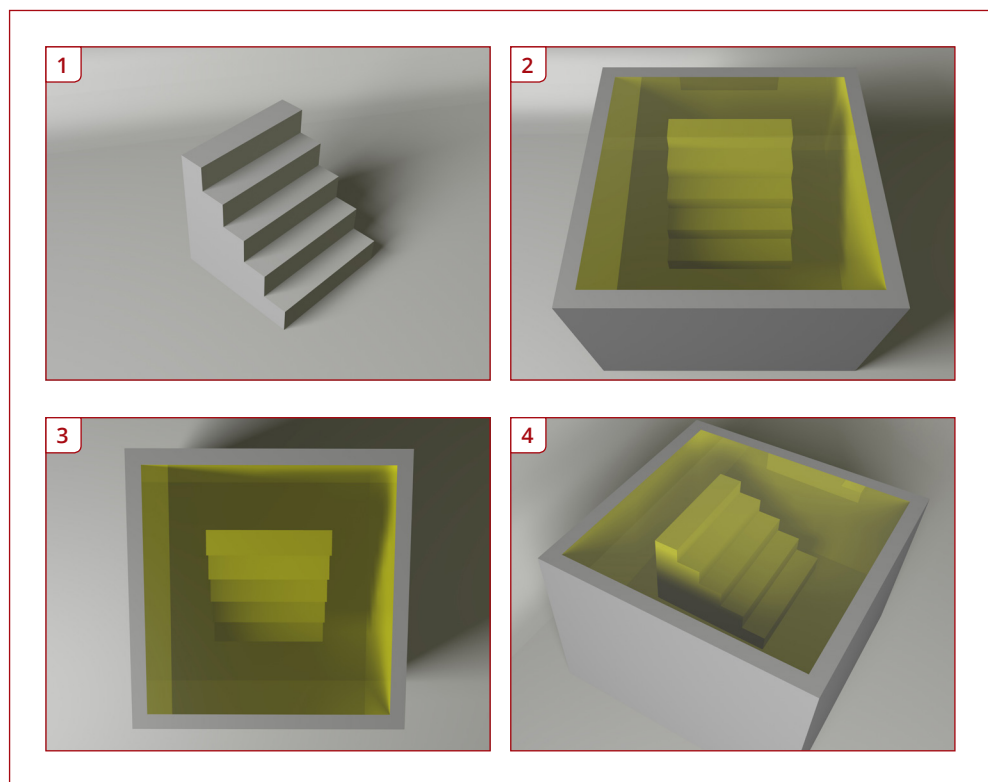

Figure 5.15 Example of Goethe's Colour Intensification.

5.13.1 Colour identification with illumination cues

Learning a color in 3D leads to a higher level of color constancy than when learning from a 2D setup. Colour constancy and identification of colour improves when

79 GOETHE, J.W.V., 1840. Theory of Colours (English Translation). John Murray.

presented in 3D scenes as it includes more illuminant cues beneficial for colour perception than 2D palette setups. (Hedrich, Bloj, & Ruppertsberg, 2009)^[80]

5.13.2 Adams' zone system for tonal ranges

Adams book series *The Camera* (1980)^[81], *The Negative* (1981)^[82] and *The Print* (1983)^[83] describes the seven zonal regions that Adams uses for the development of photographic image. With this system a pleasing tonal range is achieved within the print. With the lightest and brightest highlights being in zone I, the middle tones being in zone III and the darkest shadows being in zone VII. In many ways this is related of the 11 step and 21 step stoufer wedges used in the photographic exposure of photographs and photopolymer plates in printing. When all of the steps are developed in the wedge a fairly decent exposure time has been achieved, any additional work is mostly just the subjective fine tuning of the image.

5.13.3 Fineness of grind draw down test / Stoufer Wedge

The use of devices such as spectrophotometers are used to capture and record the spectral information contained within the hue of printed matter, especially in halftone printing. Many of the colour tests that are developed in printing are developed around processes that employ the half-tone printing process, or in printmaking processes that leave a flat and even surface on the print. Such tests and devices are not suited for photoplastographic print making or prints that contain a pronounced surface relief. Density readings can be taken to inspect the tonal ranges but are not suitable in all circumstances. A spectrophotometer will only measure a defined area not a fluctuating or textured surface.

As current spectral devices designed to assess printing the Acceptance or rejection of a colour reproduction is mainly based on ink density. These devices read prepared swatches, however most quality metrics are performed through subjective evaluation by a colour technician. Spectral readings are therefore only of use if they can match human judgements. (Verikas, Lundström, et al, 2011)^[84]

80 HEDRICH, M., BLOJ, M. and RUPPERTSBERG, A.I., 2009. Color constancy improves for real 3D objects. *Journal of Vision*, 9(4)(16), pp. 1-16

81 Adams, A. (1980) *The Camera*. the New Ansel Adams Photography Series / Book 1. 1st ed. USA: Little, Brown and Company, Ltd.

82 Adams, A. (1981) *The Negative*. the New Ansel Adams Photography Series / Book 2. 1st ed. USA: Little, Brown and Company.

83 Adams, A. (1983) *The Print*. the New Ansel Adams Photography Series / Book 3. 1st ed. USA: Little, Brown and Company.

84 VERIKAS, A., LUNDSTRÖM, J., BACAUSKIENE, M. and GELZINIS, A., 2011. Advances in computational intelligence-based print quality assessment and control in offset colour printing. *Expert Systems with Applications*, 38, pp. 13441-13447

Spectrophotometers provide a high degree of accuracy and repeatability for uniform surfaces but textured surfaces reduced the observers ability to distinguish color differences. (Trussell, Lin, Shamey, 2011) ^[85]

Due to the curing time, the viscous nature of silicone, and technical limitations with spectral devices, it was not practical to take colour readings with the spectral devices available in case of accidental damage being caused to the optical lens used for colour capture. Problems were encountered in attempts to take colour readings with cured silicone due to light scatter caused by the thickness which resulted in unreliable and inconsistent readings. As there is no benchmark for each colour being mixed a new method has to be devised allowing for a quick visual mixing method to be generated as a starting point. Through an awareness of colour intensification as described by Goethe, it was postulated that this physical feature could be used to determine ink mixing with the '*Fineness of Grind*' (FOG) Hegman Gauge. FOG tests are designed for ink grind testing, not colour mixing. The gauge could be adapted to provide a colour mix test, that will enable the user to quickly determine colour mixing. This would be specific for ink pigments that rely on colour intensification to achieve a change in tonality.

The test requires minimal skill to use and only takes a few seconds to complete the testing of a pigment sample.

The Hegman Fineness of Grind Gauge consists of a piece of engineered high grade stainless steel that is machined to precise standards. (BSI 3900 Part C6 and International Standard ISO 1524). The gauge is used for the determination of dispersion. The test consists of placing a small volume of ink on the deep end of the gauge and drawing it with a straight scraper toward the shallow end. The position of the scale where oversize particles and their tracks appear can be rated for determination of pigment dispersion (Sheen Instruments, 2016) ^[86].

As stainless steel is not white in colour it becomes unsuitable for determining the colour mixes of transparent mediums. Dense white plastic such as polyurethane can be cast into blocks and then machined to the specifications that are required to match the photographic relief plate, enabling a test procedure to be developed suitable for the printing method used in this study.

The Sheen branded scraper part ref: 505 is used with custom test gauge to complete the physical test.

85 TRUSSELL, H.J., LIN, J. and SHAMEY, R., 2011. Effects of texture on color perception. IEEE 10th IVMSWP Workshop: Perception and Visual Signal Analysis, , pp. 7-11

86 Sheen Instruments Physical Testing: Fineness of Grind Gauge. Available from: <http://www.sheeninstruments.com/sites/sheeninstruments.com/files/SHE4-FineGrind.pdf> [Accessed 21/09/2015].

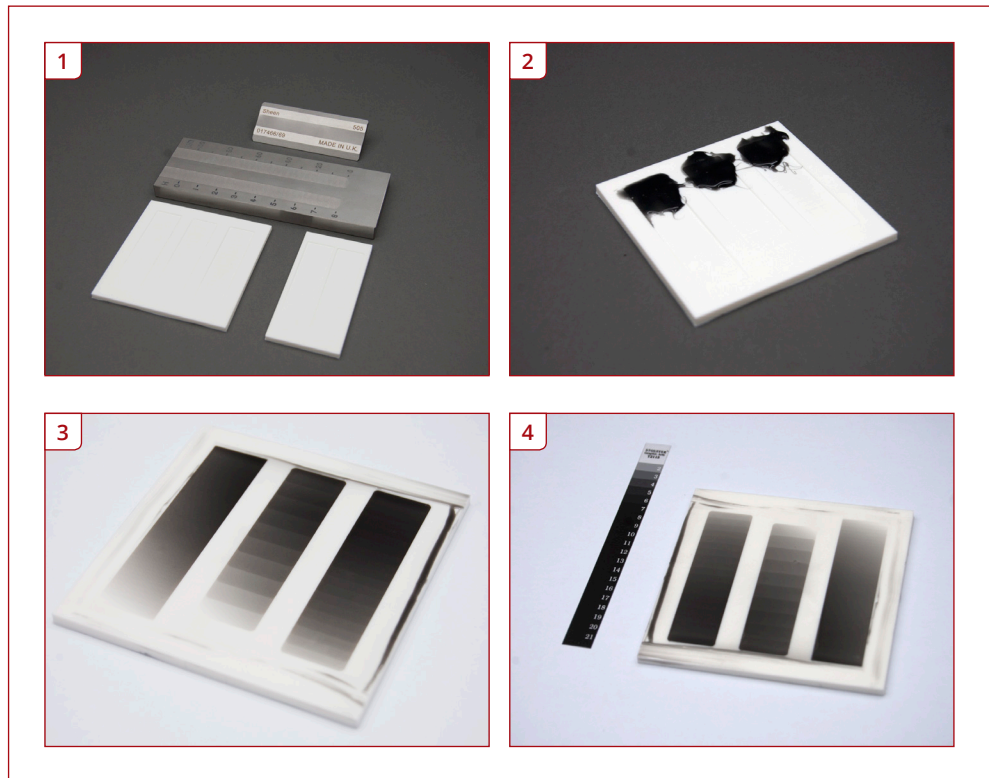

Figure 5.16 1)Fineness of Grind Gauge, cnc milled gauge and scraper 2) CNC milled gauge loaded with pigment 3) CNC milled gauge with pigment drawdown 4) Visual comparison of pigment drawdown with Stouffer Wedge

Windsor and Newton Calligraphy Ink with 25ml water - 0.5mm Tone ramp	
Light Blue	0.25-0.55
Scarlet	0.35-0.45
Lemon Yellow	Max Out
Windsor and Newton Ink with 25ml water	
Cobalt	0.25ml - 0.95ml
Carmine	0.25ml - 0.35ml
Crimson	0.25ml - 0.65ml
Deep Red	0.65ml - 0.85ml
Sunshie Yellow	0.55ml - 0.85ml
Canary Yellow	1.45ml - 1.65ml
Windsor and Newton Indian Ink with 25ml water - 0.5mm Tone ramp	
Indian Ink	0.25ml
Liquitex Ink with 25ml water - 0.5mm Tone ramp	
Black	0.05-0.15ml
Yellow Med	Not Suitable
Yellow Orange	0.15-0.35ml
Magenta	0.05-0.25ml
Turquoise	0.05-0.15ml
Pthalo Blue	0.05-0.25ml
Daler Rowney System 3 Acrylic with 150ml water - 0.5mm Tone ramp	
Process Cyan	5ml
Process Magenta	25ml
Process Yellow	5ml
Slic Pig Silicone Ink - 1mm Tone ramp	
Black	0.45ml per 100g of silicone
Brown	0.1ml per 40g of silicone
Slic Pig Silicone Ink - 0.5mm Tone ramp	
Blue	0.05ml per 80g of silicone
Red	0.05ml per 80g of silicone
Yellow	0.05ml per 80g of silicone
White	0.3ml per 80g silicone

Table 5.2 Pigment mix chart

5.13.4 256 Steps and image test

Figure 5.17 256 tonal range test

A more complex test was constructed that would allow inspection of the stepping motion of the CNC milling device under a microscope. A test image was selected that contained a contrast image of a female portrait and a radial gradient background. The test contained a matrix grid of all 256 tonal steps as square patches in conjunction to a 21 step wedge and a tonal ramp.

The file was milled into unfilled high density polyurethane at the highest settings to obtain the best possible result. The depth of the milling was 0.5mm to maintain consistency among the test images. The digital transitions between each tone step was observed in Adobe Photoshop on inspection of the patches. All 256 tones were being produced within the digital output file.

A step wedge was milled at a depth of 0.256 mm allowing for one micron per tone change. Upon inspection under the microscope, it was difficult to observe a noticeable change in the surface until raking light was added. This confirmed that the subtractive manufacturing was accurate and that a physical step existed between each change in surface relief.

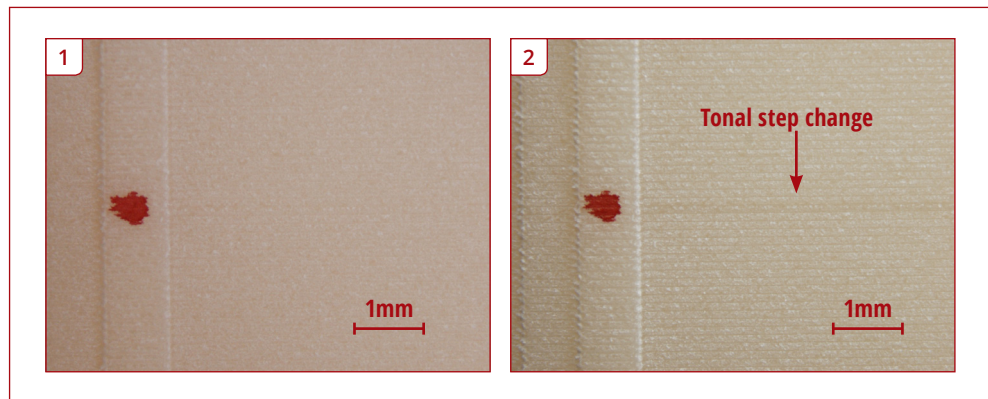

Figure 5.18 256 Step chart 1)2)

If it was possible to output a 9 bit image to the CNC device, one could then theoretically be manufactured through CNC at a depth of 0.512mm. Following that logic a 10 bit image could also be achieved at a depth of 1.024mm

5.14 In summary

This chapter introduced and discussed the elements of digital greyscale images and how they can be translated into a set of physical Cartesian co-ordinates. It then went further and demonstrated how manufacturing processes can use that data to produce relief intaglio printing plates of a similar type to the Woodburytype process. These digitally produced plates contain the dark tone information within the low relief and the highlight information in the high relief.

Test methods were discussed showing how current print testing methods are not suitable for this style of printing and how new tests were devised by adapting existing testing procedures. The testing procedures for the visual assessment of fluid inks were demonstrated showing how a satisfactory tonal range can be achieved.

5.14.1 Next chapter

Chapter 6 will present the contribution to new knowledge within this study. It will present the methods and results generated through the development of a new continuous tone printing method that produces three colour photo-realistic prints based on the Woodburytype model.

6 Colour printing method for the reproduction in continuous tone of digitally printed colour artworks

Synopsis: This chapter presents the main contribution to knowledge for this doctoral research project. It demonstrates a continuous tone colour printing method capable of reproducing photographic imagery by changing the thickness of the ink deposition and altering the surface topography. The process will be described in the order of its development; starting with monotone printing and progressing to two colour printing and eventually to three colour printing. It will state how the method can be adapted to include more than 3 colours. Microscopic image captures of the prints will be used to present the results. They will show that through changing the surface relief of the ink deposit the tonal and hue qualities within the image will also change in a predictable manner. The final summing up concludes with a comparison of half-tone printing processes, contone printing processes and photographic processes with the new process proving that the prints produced through this method are true continuous tone images and contain no reticulation or patterns often associated with other printing processes.

6.1 Further development of a printing process

The literature review highlighted several limitations and variables which restricted the Woodburytype process in the attempt to make it a colour process. These problem areas were affirmed through the empirical replication of the process. The workings of the process contain many variations each with their own variables that can prevent a definitive step-and-repeat technique being developed.

This research addresses the topic of printing photo-realistic images by layering individual colour separations as a single relieved ink deposition for each primary colour. It was suggested in chapter 1 that one reason digital printing evolved primarily as a half-tone process was due to the linear fixation within the design and development of the process. Topalian (1980)^[1] indicates that in design project management there are

¹ TOPALIAN, A., 1980. The management of design projects. 1 edn. London: Associated Business Press.

several approaches to creative problems, that every creative or design problem has a different creative solution. When developing a solution we as designers inherently draw from our experiences to provide what we feel is the best solution to the problem. We therefore identify, adapt and change. Creatives who use the same approach over and over become fixated and ultimately their work looks the same. I would say that the development of inkjet printing has been a series of linear iterations of the half-tone process, and that problems such as moiré etc. are merely the symptoms of the process. Henrik Gedenryd in his 1998 thesis 'How designers work' ^[2] found ultimately that no design process can deliver a perfect one-solution-fits all and ultimately every "perfect" design process is destined to fail. Only processes that are designed to be adapted and changed, allowing for growth and further development, are the ones that stand the test of time. This research will now re-addresses how images can be translated without the need for halftoning.

In the previous chapter additive and subtractive manufacturing processes were discussed. This chapter utilises those technologies for the production of the printing plates within this research. An explanation of how the printing plate was developed through the generation of greyscale heightfields is also given. In this chapter the heightfield reliefs will be generated to allow for colour separation development and registration methods. The leap in knowledge is generated by developing a continuous tone printing method that was originally monotone into a colour printing process. As such the development leading to this 'leap' was done in small incremental steps. Each print test was designed through empirical investigation that would add to the previous investigation. By controlling the variables through each part of the process it allowed specific goals and outcomes to be met. The printing method will be presented in the chronological linear order of its development. The results of each empirical investigation will be shown after it is described allowing for the natural progression into the next part of the investigation to become apparent. At the end of this chapter the results will be summarised and a visual comparison between this method and other printing methods will be presented to show that this new method does not produce colour in the same way.

6.1.1 Development of a plastographic ink

The Woodburytype ink was different to other processes as it used a warm liquid gelatine that carried the pigment in suspension. The printing plates were essentially moulds that allowed the ink to set against paper or opal glass that when removed contained the image as a relief shape. The initial difficulty is that unlike the tri-chrome carbon or carbro processes the gelatine is not in a state where it is easy to apply more

2 GEDENRYD, H., 1998. How designers work. Making sense of design as a cognitive activity., Lund University Cognitive Studies

layers of colour. Applying warm gelatine on top of cool gelatine will simply melt the layer of cool gelatine below.

This presents two options to investigate, firstly a non-gelatine alternative ink, and secondly a method to control the setting of gelatine-based printing ink.

6.1.2 Silicone ink - initial test

Silicone, urethane and other plastics were looked at as alternatives to gelatine. Unlike gelatine, these materials cure to a fixed solid or flexible state. These materials can also be coloured and tinted to various levels of transparency and intensity.

A two part addition cure silicone by SORTA-Clear® (Smooth-On, 2016) ^[3] was used as a pigment vehicle. It is a water-white material. Technical data sheets for waterclear silicone products did not have the same tensile strength or shore hardness and were unsuitable for casting in very thin thicknesses (Smooth-On, 2016). ^[4] As an initial starting point the water white silicone was acceptable. This product uses SLIC Pig® pigments (Smooth-On, 2016) ^[5] conforming to Pantone™ swatch colours. These do not inhibit the curing process and are designed specifically by the manufacturer for this product (Smooth-On, 2016). ^[6] Other pigments were tested but inhibited the curing process of this silicone brand making them non-viable pigment options, a list of these pigments is available in Appendix 6.

An initial print test was developed that would determine if the silicone could be used as a printing medium. An 11 step tone wedge printing plate was modelled within McNeel Rhinoceros 3D software with a depth of ranging from 0mm to 1mm. This allowed a height change of 0.1mm for each 10% black tonal increment. The tone ramp was then 3D printed using a Stratasys Eden Polyjet 3D printer. The details of the printing block can be found in Appendix 6.

3 SMOOTH-ON, , SORTA-Clear® Series Addition Cure Silicion Rubber Compounds Technical Bulletin. Available: https://www.smooth-on.com/tb/files/SORTA_CLEAR_SERIES_TB.pdf

4 SMOOTH-ON, Smooth-On SORTA-Clear® 40 Safety Data Sheet SDS No.823A. https://www.smooth-on.com/msds/files/BD_DS_Eco_Equ_EZB_EZS_Psy_MS_OOMOO_Reb_ST_SS_Soma_Sol_Sorta.pdf edn.

5 SMOOTH-ON, , SLIC Pig® Pigments for Tin and Platinum Silicone Rubbers Technical Bulletin. Available: https://www.smooth-on.com/tb/files/Silc_Pig_Pigments.pdf

6 SMOOTH-ON, , Smooth-On SORTA-Clear® 40 Safety Data Sheet SDS No.823A. Available: https://www.smooth-on.com/msds/files/BD_DS_Eco_Equ_EZB_EZS_Psy_MS_OOMOO_Reb_ST_SS_Soma_Sol_Sorta.pdf

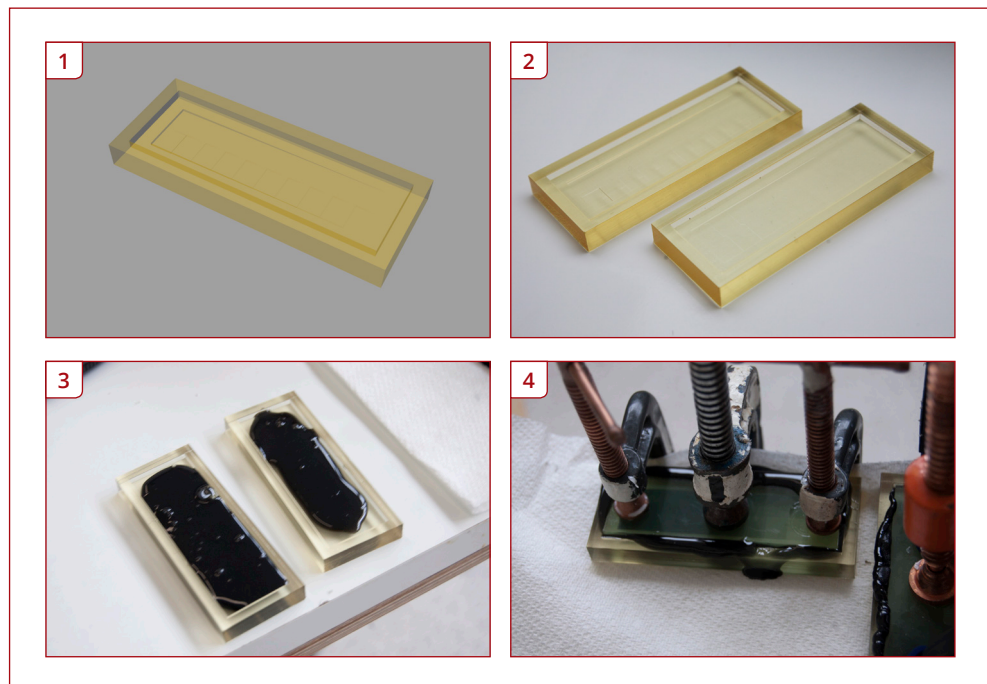

Figure 6.1 1) 3D model of the printing block. 2) Final printed block. 3) The silicone ink is poured onto the surface of the block. 4) The lid is placed onto the block and is clamped closed until the silicone has cured. The tonal ramp is visible through the clear lid of the mould.

The manufacturer's volume calculator (Smooth-On, 2016)^[7] is used to determine the minimum volume of silicone required to fill the printing plate. As some of the silicone ink will be lost in the mixing process due to it sticking to the containers a further 20% was added to compensate for this loss. Pigment is mixed in to achieve a suitable intensity using the gauge method described in chapter 5. Once mixed as per the manufacturer's instructions it is poured onto the printing block, the lid is placed on top of the ink and it is clamped shut where any excess ink is forced out. Once cured the clamps are removed.

7 SMOOTH-ON, , Mold Making & Casting Calculators. Available: <https://www.smooth-on.com/support/calculators/>

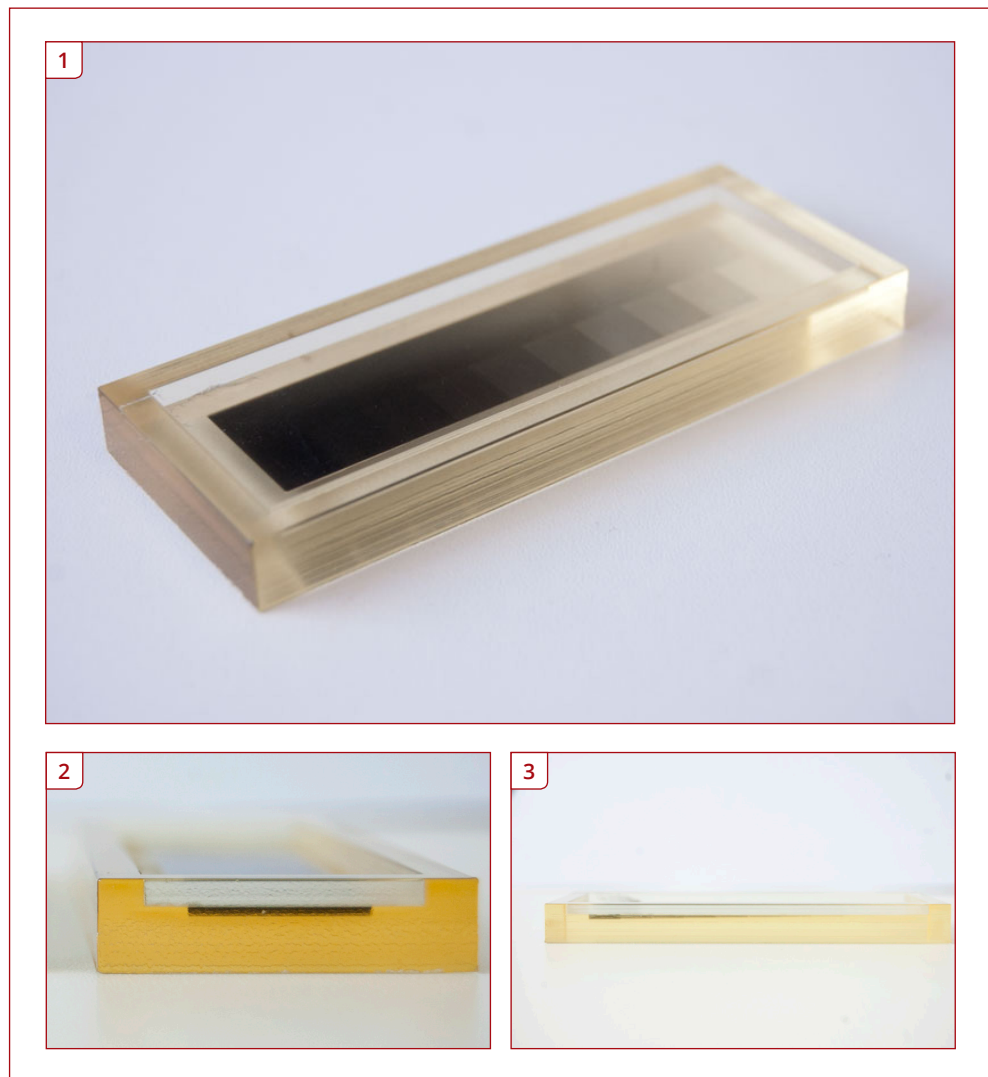

Figure 6.2 **1)** The lid has been removed and the “print” is still within the printing block. The tonal steps are very visible at every 10% tonal increment. **2)** The pigment is seen at the deep end of the relief through the transparent 3D printed printing block. **3)** The tonal ramp is visible with pigment highlighting the change in height.

A smooth glossy photo ink-jet paper was placed in contact with the cured silicone ink. Gentle pressure was applied and the paper was peeled back from the printing block lifting the print out of the mould. This can be seen in Figure 6.3.

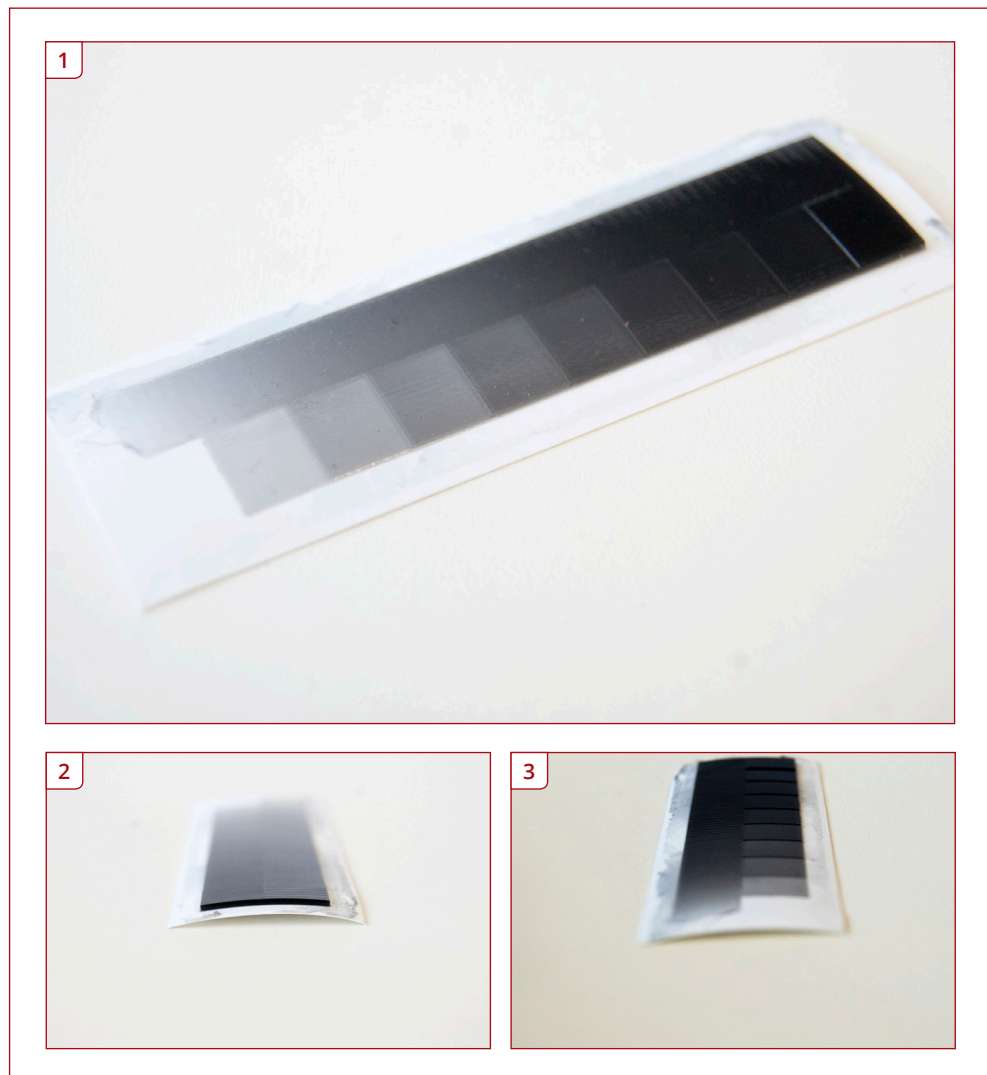

Figure 6.3 1) The tone wedge print is attached to the paper support. Changes in tone are very visible throughout the print. 2) The relief print as viewed from the dark tones. 3) The relief print as viewed from the highlights.

6.1.2 Silicone ink initial observation

This initial test was to investigate whether or not silicone could be used as a printing medium allowing tonal change to occur through relief. The initial printing block was not designed to render a photographic image due to resolution limitations within the device. Polyjet printing builds relief by spraying a UV curing polymer in layers and curing them with a UV light. Each layer deposited by the device used is 16µm in thickness. To achieve an 8 bit tonal range of 256 grey-levels the mould would need to be 4.09mm deep. At this early stage of the investigation this was considered too thick and that CNC milling would be a more suitable printing plate production method at this point.

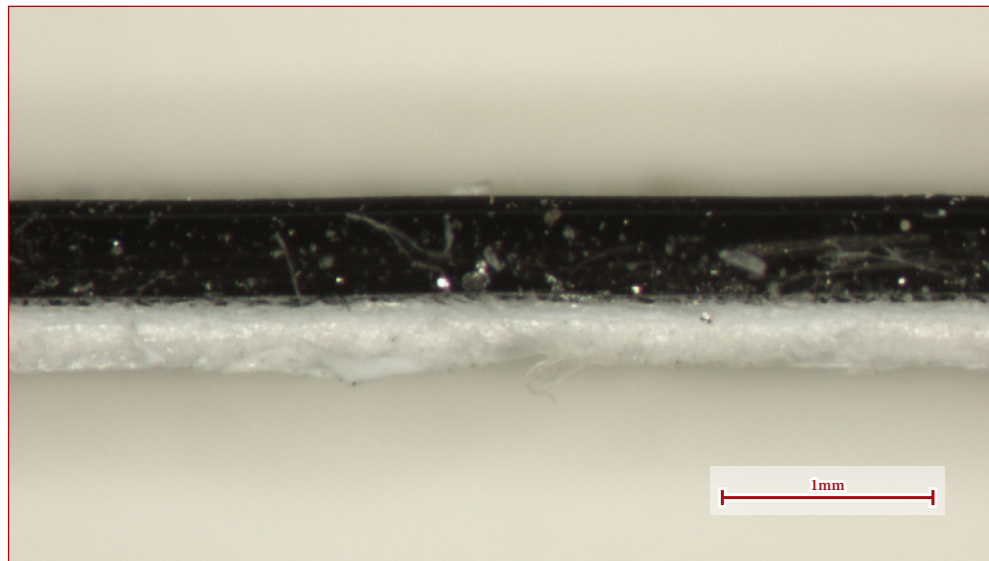

Figure 6.4 Cross section of the silicone print showing the silicone ink (black) adhered to the paper surface (white) beneath it.

Microscope captures show that the print sits on the surface of the paper in relief (Figure 6.4) and that no cell structure is contained within the printed image (Figure 6.5), this would indicate that silicone can be used to take the shape of the printing plate and suspend pigment without a reticulation pattern.

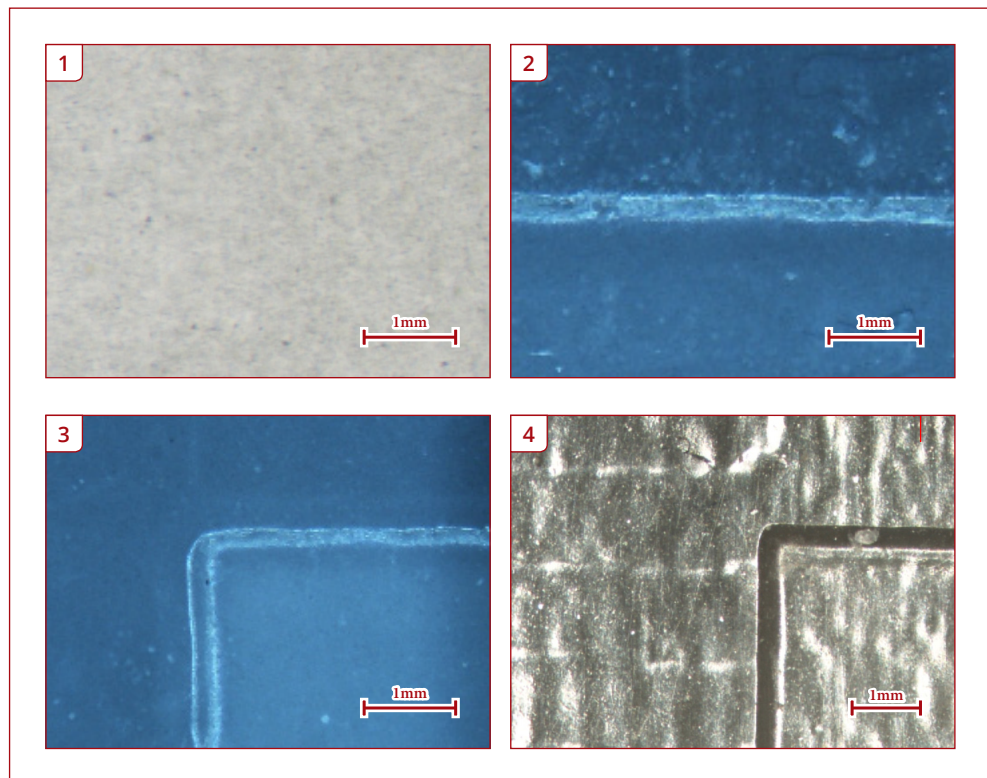

Figure 6.5 Microscope captures of: **1)** highlights area showing pigment suspension. **2)** 10% relief stepping. **3)** Corner section without a raking light. **4)** Corner section with raking light. Notice the horizontal lines on image. This is the 16 μ m layering from the polyjet printer.

6.2 Photographic relief

Having established that silicone can be used as a printing medium for non-photorealistic renderings a printing plate containing a greyscale image was produced to the same depth thickness (1mm) as the tone-ramp to keep the colour and tone comparison consistent within the early tests. A 3D model was generated from the greyscale information contained in the photographic image. This was then CNC milled using a Roland MDX-545 CNC mill with a 0.25mm conical flat engraving tool. *Neucuron 480* model board was used as a substrate. An attempt to print directly from the surface failed resulting in the image becoming fused to the surface (Figure 6.9). This was due the omission of a release agent. Two methods were tested to include a release agent / surface barrier for the printing surface.

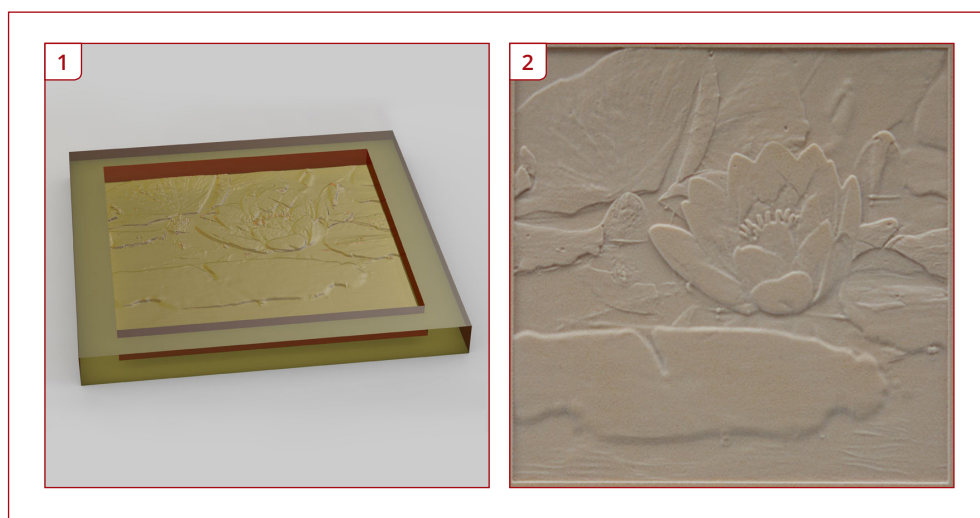

Figure 6.6 1) Model generated in Rhinoceros 3D. 2) CNC milled surface relief of the printing plate.

6.2.1 Stannotype surface / surface barrier

A layer of tinfoil was burnished onto the surface of the printing block using a series of artist paint brushes, starting with a soft squirrel hair brush and moving up to a firm synthetic acrylic bristle. This resulted in a smooth polished metallic surface from which to pull the print from.

6.2.2 Wax barrier release agent

The second method involved sealing the surface with a sanding shellac by carefully rubbing it on and off avoiding infill of detail on the relief. Once dry, a thin layer of a micoline renaissance wax was applied and buffed to a polish. Specific details and products tested are in Appendix 6. In later tests the renaissance wax was substituted for a fine aerosol spray wax release agent. This was specific for use in model making was also used and was found to be very effective.

6.2.3 Initial paper substrate tests

As in the initial ink test the silicone ink was prepared and poured onto the printing plates. A flat smooth acrylic lid was placed on top and the plate was clamped. When cured, the mould was unclamped and different papers were applied to the print samples and gentle pressure applied. The prints could then be lifted from the plate attached to the paper substrates. The papers that worked best for taking the prints in this manner were coated digital inkjet papers, (photo-gloss, photo-satin and photo-matt) and gelatine resin coated photographic paper.

Paper could also be placed on top of the silicone and a tympan placed on top of the paper and before it was clamped. It was found that the silicone would bond to papers

without any significant issues, however paper that had rough fibres did effect the tonality of the image (Appendix 6).

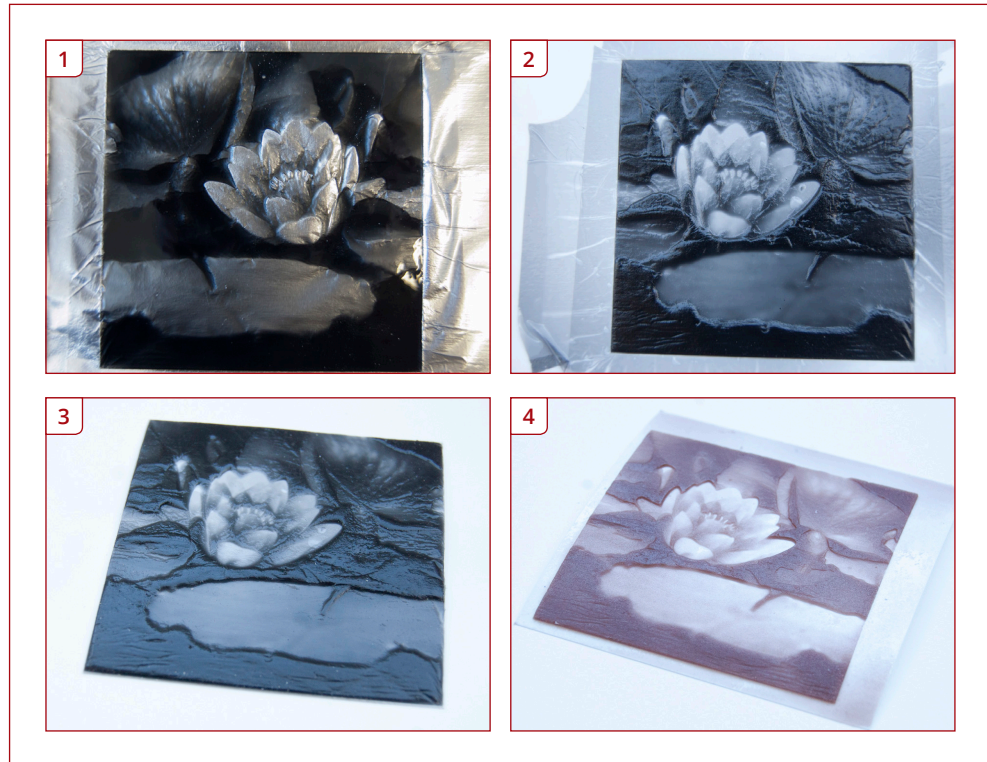

Figure 6.7 1) Silicone ink cured within the Stannotype printing block with the tinfoil surface. 2) Stannotype print transferred to paper, notice the excess silicone beyond the image. 3) Final printed image on paper and trimmed back to image boundaries. 4) Matt finish on print taken from a waxed plate and cured directly onto the paper substrate.

6.2.4 Surface finishes

The prints taken from the smooth metallic surface cured to a high sheen, whereas the images taken from the waxed surface cured to a matt finish. The printed results can be seen above in Figure 6.7. A photo-realistic image was successfully printed using silicone as a printing medium.

When examined under microscope (Figure 6.8) the results are consistent with Woodburytype; the cross-section image indicates that tonality is proportional to relief and the pigment is suspended without reticulation or a pattern structure.

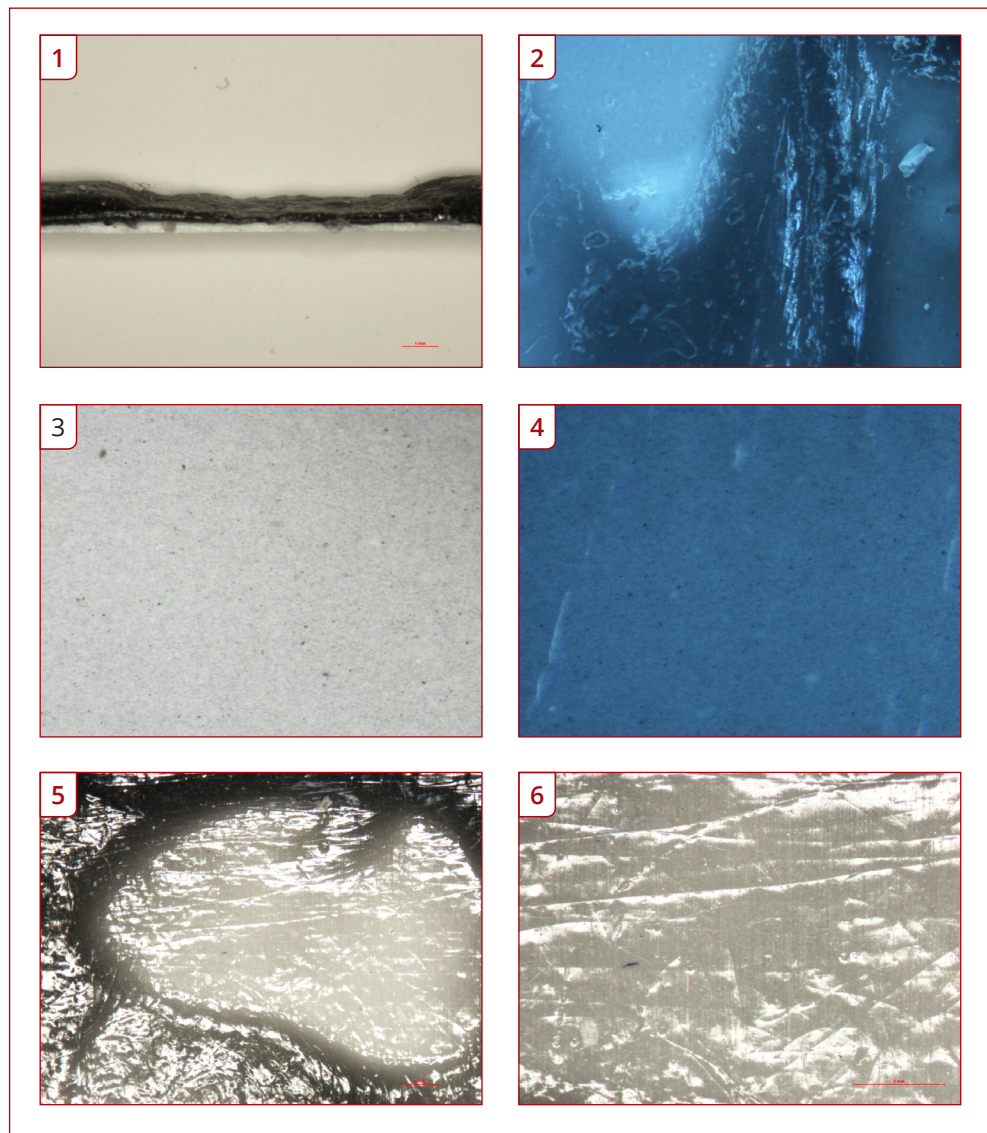

Figure 6.8 1) Cross section of photo-realistic image depicting undulating surface relief. 2) Sharp tonal change from dark to light within the image achieved through a change in relief height. This is particularly noticeable with the reflected light on the right hand edges of the print. 3&4) Image capture of highlight and mid tone areas within the image. The pigment suspension in both microscope captures are similar showing pigment particles. 5) Close up of the lilly contained within the image. This capture highlights the sharp change in relief height from dark to lighter tones 6) Surface texture of silicone image.

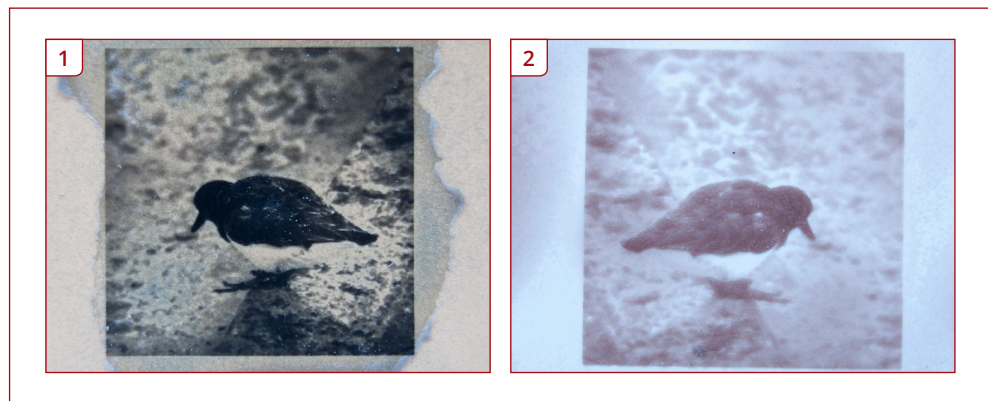

Figure 6.9 1) Image of small bird that was cast without release agent and fused to printing plate.
2) The same image printed directly to paper with the aid of a wax release agent.

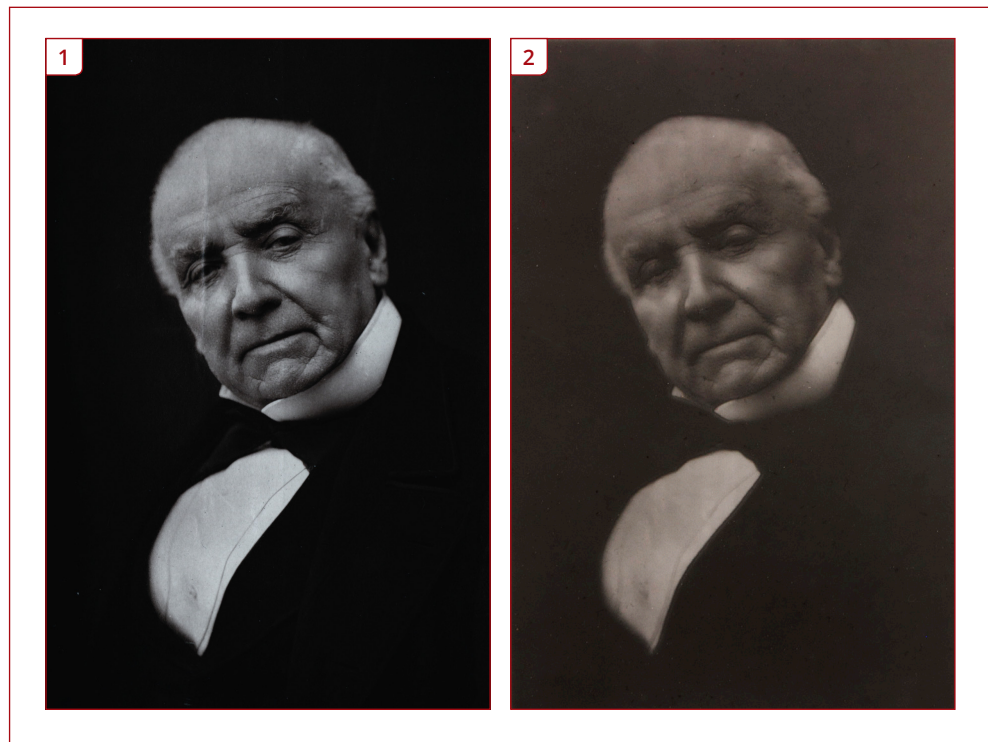

Figure 6.10 1) Scan of a 19thC Woodburytype to be re-created as a silicone relief print.
2) Silicone relief print produced from a scan of an original Woodburytype. Note: The input image was corrected prior to milling the printing plate. The crease in the print (image 1) was removed from the face so it was not reproduced (Image 2). The silicone image had a height relief of 0.5mm.

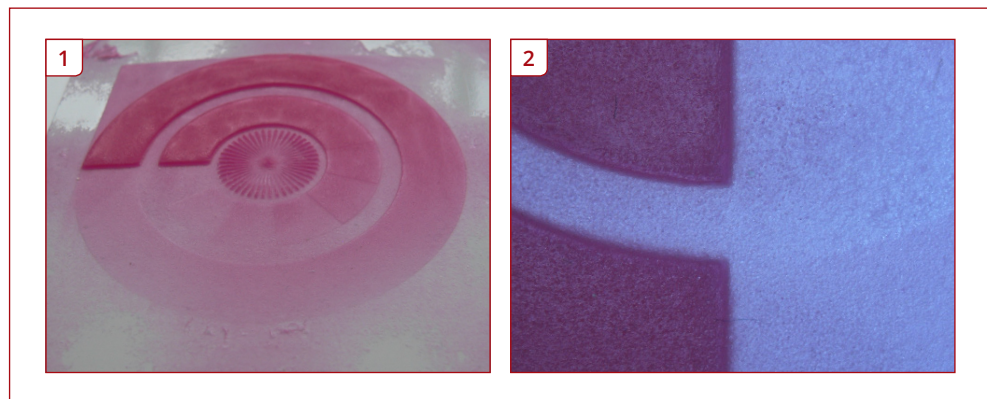

Figure 6.11 1) A circular tone ramp print milled to 0.5mm in depth. The centre ring has a standard printers target star for resolution and ink infill. The middle ring contains an 11 step tone ramp increasing in 10% increments from 0% to 100%. The outer ring is a continuous tone wedge ranging from 0% to 100%. 2) Microscope capture of the 0% and 100% section of the tone circle highlighting the 0.5mm change in relief.

6.3 First steps to two-colour imaging

As it has been established that silicone can be used in monotone printing, it needs to be ascertained if it will bond to itself as a second colour separation when printed.

6.3.1 Duotone Printing

The simplest method of determining if the ink can bond to itself is to create a two colour print consisting of individual silicone reliefs cast in two stages. The initial colour will be cast as before so that it has a flat surface on the back. Then the second colour separation will be cast against this flat surface of the first colour using a second interlocking printing plate. The design of the plates allow them to be bolted shut in registration as the silicone cures. The design details are in Appendix 6.

The water-lily test image used in the monotone print was converted to a duotone image consisting of SLIC Pig® Pantone™ 4625 Brown and SLIC Pig® Pantone™ Black separations. The result will produce a duotone print that is sepia-like in appearance. Figures 6.12 to 6.13 show the processes involved and the printed results.

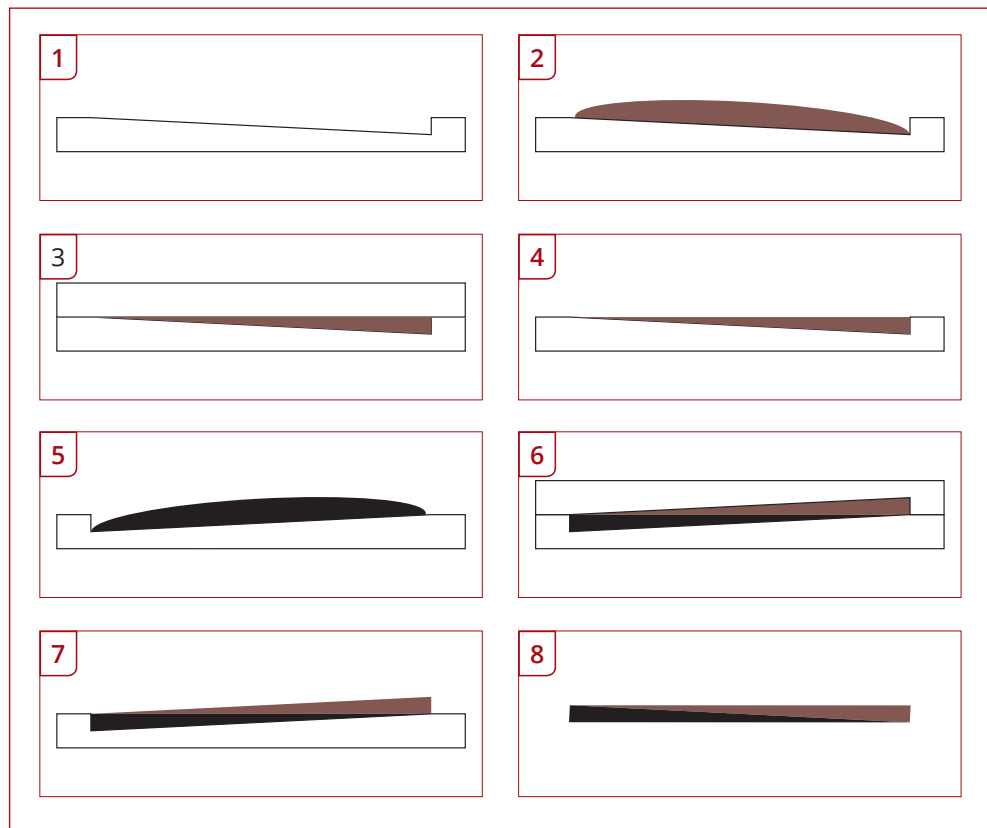

Figure 6.12 Description of two colour print process. **1)** The printing plate is prepared. **2)** The first colour (SLIC Pig® Pantone™ 4625 Brown) is poured onto the plate. **3)** A flat typan lid is pressed down onto the plate expelling excess pigment. **4)** Once cured the typan lid can be removed exposing the cured print. **5)** A second plate is prepared and the second separation colour (SLIC Pig® Pantone™ Black) is poured onto the plate. **6)** The first printing plate with the print still contained within it is used as the tyman lid and pressed against the second plate expelling excess pigment and creating a bond with the silicone. **7)** When cured the plates are opened revealing the print. **8)** The two colour print is removed from the plate.

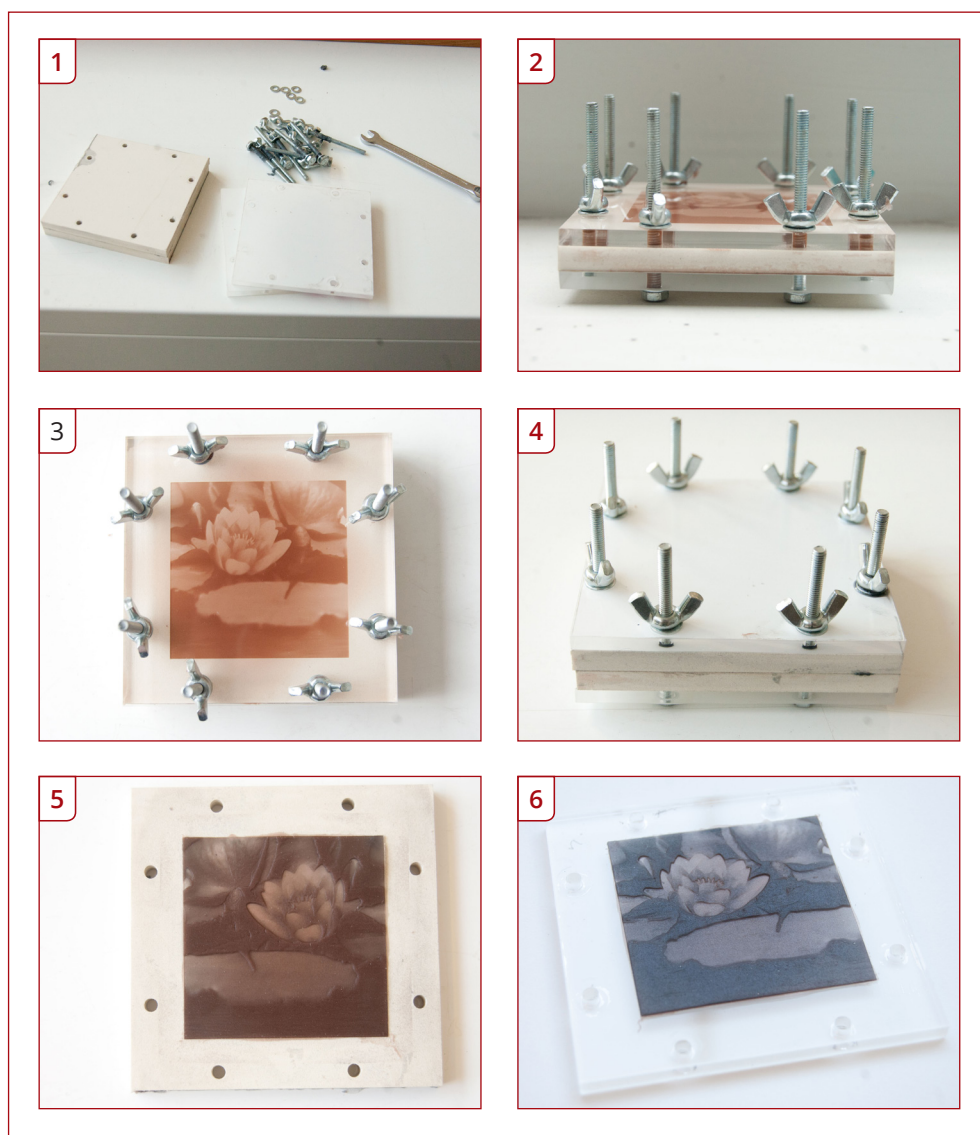

Figure 6.13 Duotone Steps: **1)** The printing plates, acrylic typan, and nuts and bolts needed to close the printing plates during the silicone curing. **2)** Side profile showing the small printing jig. **3)** Plan view of the printing jig. The image can be seen through the clear acrylic typan lid. **4)** Both printing plates bolted shut allowing the second colour to cure. **5)** The plates are opened to reveal the duotone image made from brown and black separations. **6)** The image has been removed from the printing plates. Both sides are in relief.

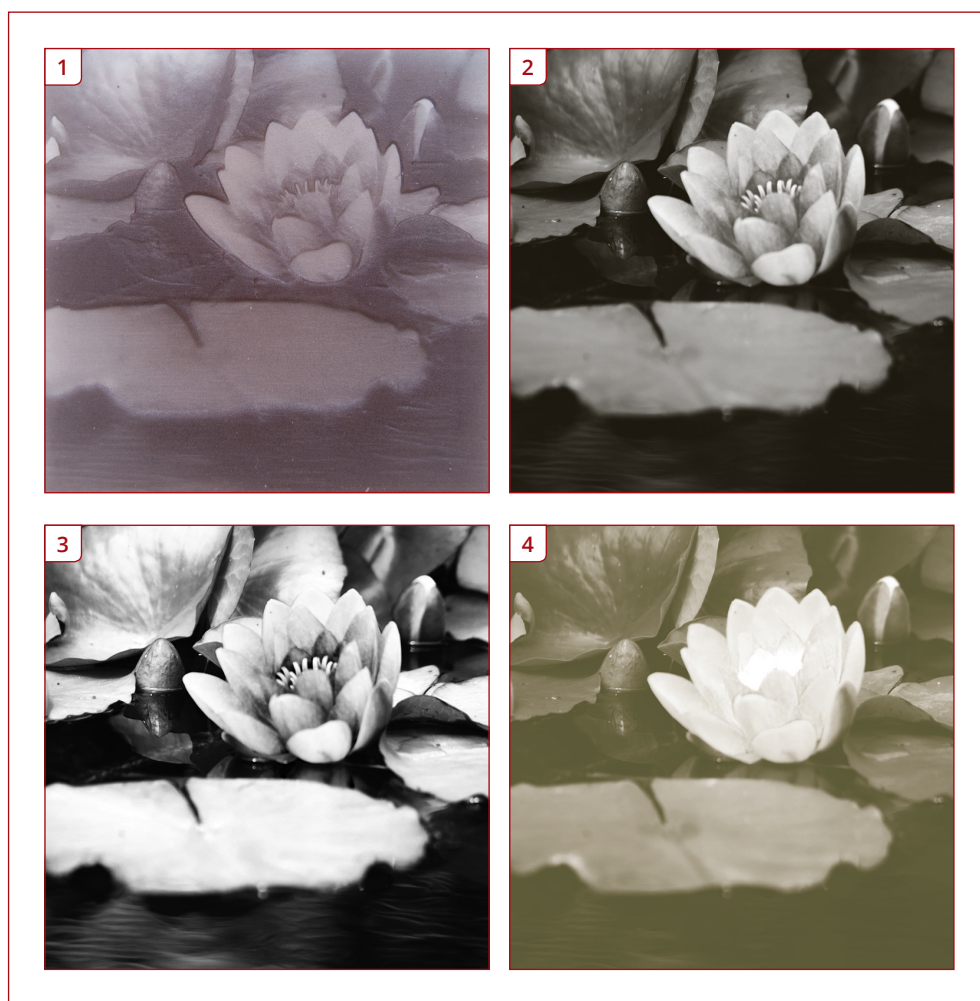

Figure 6.14 Predictability of image **1)** Final printed image. **2)** Predicted duotone generated in Adobe Photoshop. **3)** Pantone™ Black Separation **4)** Pantone™ 4625 Brown Separation

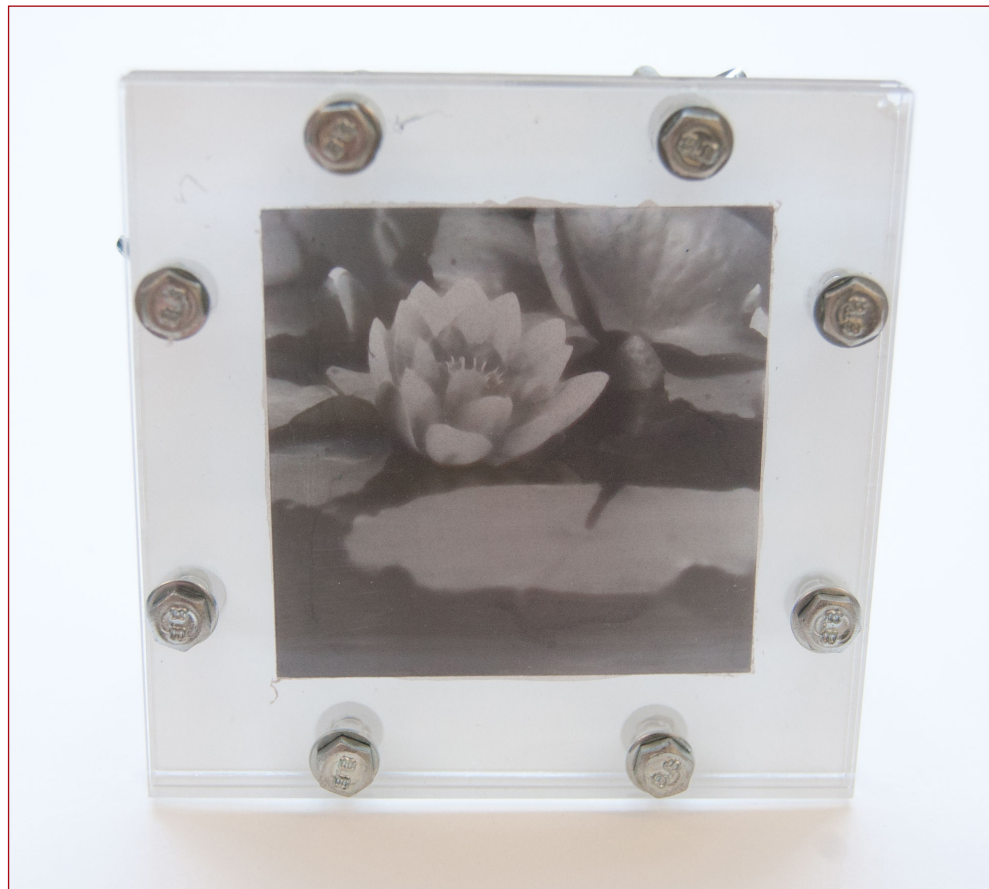

Figure 6.15 The duotone image is placed in an acrylic frame and backlit to show that it is in registration.

6.3.2 Duotone printing observations

The duotone printing test had two aims. The first was to ascertain whether the ink would bond to itself and cure fully. The second aim was to ascertain a method that allowed separations to be designed into a printing mould that could be bolted together keeping the image in registration while the silicone inks cured. Both objectives were met successfully. From this another empirical test was developed to investigate secondary colour mixing from two different primary colour separations.

6.3.3 Two colour separation from different plates

A two colour separation was generated by splitting a test image into its individual CMYK separations. The cyan and magenta separations were combined into one image file to make the first printing plate. The yellow and black separations were combined together to make a second printing plate. This ensured that the tonal ranges were split in two and both images would be completely different in their tonal values. The aim here was to be produce an image using two colours and demonstrating secondary colour mixing. As both separations are completely different there should be a very

clear depiction of secondary colour mixing within the print. Weak mixes of SLIC Pig® Pantone™ 2757 Blue and SLIC Pig® Pantone™ Red was made for the silicone ink. SLIC Pig® is extremely concentrated and so cannot be made to full strength otherwise it would be opaque. The weaker mixes produce hues closer to cyan and magenta in appearance. The images were printed in different batches, so that the colour orders could swapped about producing two different images from the same plates.



Figure 6.16 Secondary colour mixing. **1)** The plates are split open to reveal the images. **2)** Close up capture of the relief surface **3)** Print #1. **4)** Print #2.

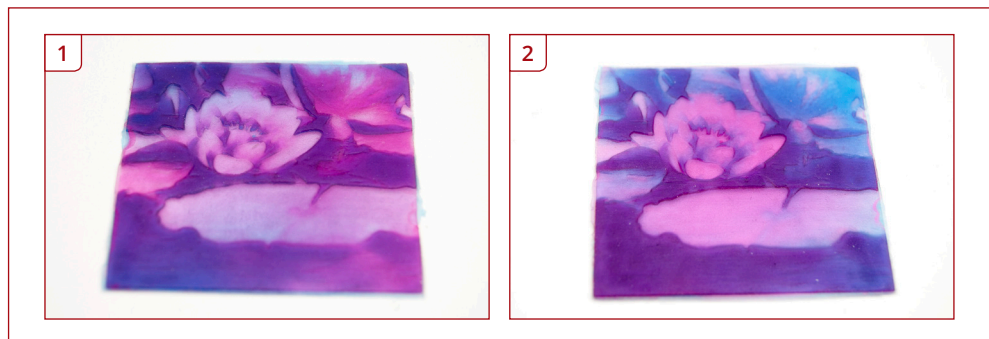

Figure 6.17 Secondary colour mixing. **1&2)** The final prints. Printed from the same plates but the colour applied in different orders. In both image there is a clear depiction of the primary colours cyan and magenta with a purple secondary mix.

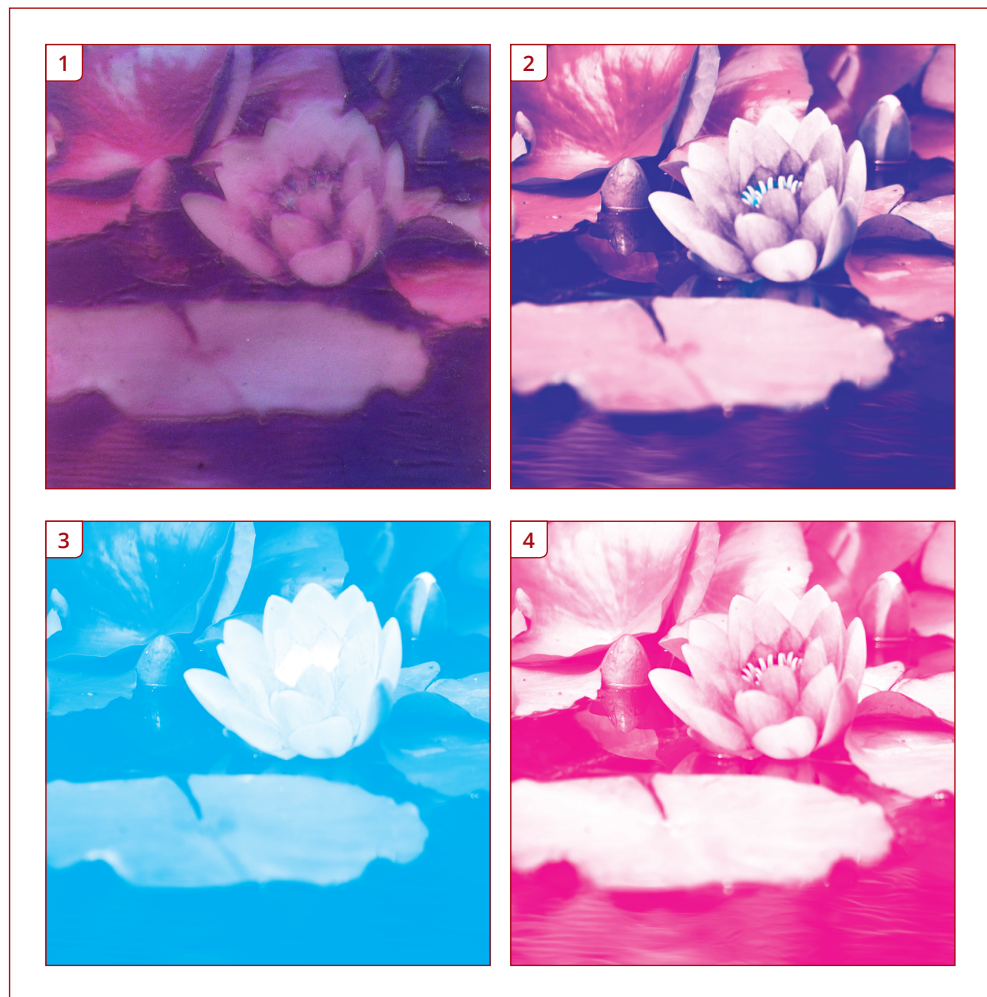

Figure 6.18 Predictability of image **1)** Final printed image. **2)** Predicted two colour separation generated in Adobe Photoshop. **3)** SLIC Pig@ Pantone™ 2757 Blue separation. **4)** SLIC Pig@ Pantone™ Red separation.

6.3.4 Two colour printing observations

The proposed image was visualised in Adobe Photoshop and the final printed image was faithful to the predicted rendering. The secondary colour mixes occurred where they were expected and in registration.

6.3.5 Overall duotone and two colour observations

Secondary colour mixing is achievable. These initial observations into printing with two separations has generated photo-realistic images in more than one colour in continuous tone. At this point of the empirical studies new contributions to knowledge are being made. This is demonstrated in both tests as the microscope image captures in Figure 6.19 verify. There is no reticulation in the image structure and no half-tone patterns. The relief and surface texture of the prints are visible and the relief changes

in correlation with the tone. Secondary colour mixing is achieved where the reliefs overlap. The next empirical study will introduce a third colour to allow for tertiary colour mixing from three primaries.

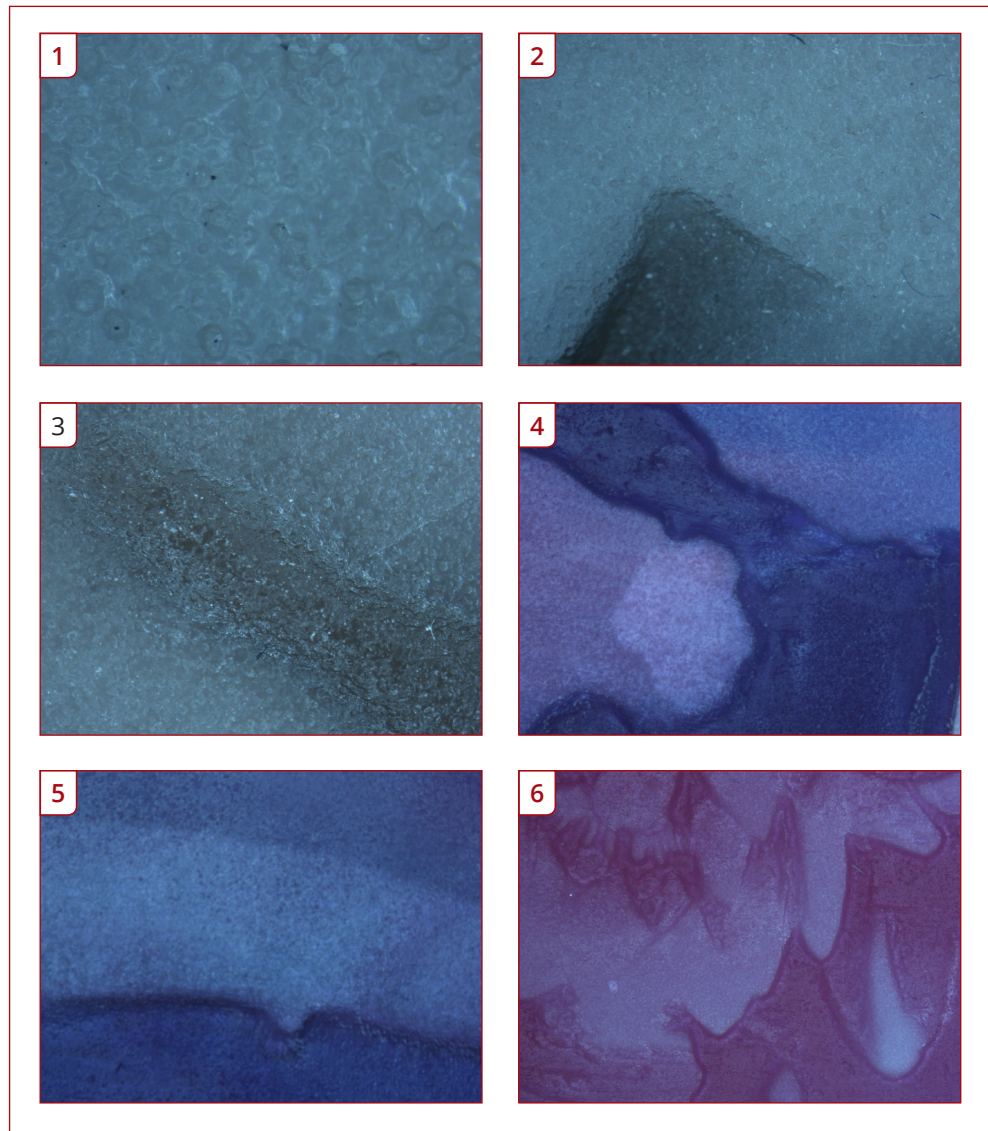

Figure 6.19 Microscope captures 1-3) Duotone image prints 4-6) Two colour separations prints

6.4 Tertiary colours

Continuing from two colour printing, the next logical progression is to produce a three colour mix that will generate an image through tertiary colours by overlapping, primary, secondary, and tertiary separations. An improved printing jig has been designed for this stage of the investigation due to the set-up and clean down times involved using the bolt printing plates. In total four printing jigs were manufactured allowing for multiple prints to cure at the same time. The new printing jigs use quick release clamps and the details of the jigs are described in Appendix 6 and photos of them can be seen in Figure 6.26.

The three colour mixing is based on the premise that when the colours are layered and viewed from above they will optically mix into the expected secondary and tertiary colours. Cyan and magenta will produce blue. Cyan and yellow will produce green. Magenta and yellow will produce red. The combination of all three will produce the dark tertiary colour as close to black as possible and so on, (Figure 6.20) At this stage of the investigation it was still uncertain how a photo-realistic rendering could be achieved given the complexities of being able to calculate the pixel heights. Each printing plate would have to take into consideration the physical height of the cured deposition that was previously printed so that the next colour would be cast at the correct height in relief allowing for faithful colour mixing. Due to this temporary restriction at this point of the investigation, the first three-colour test consists of square colour swatches.

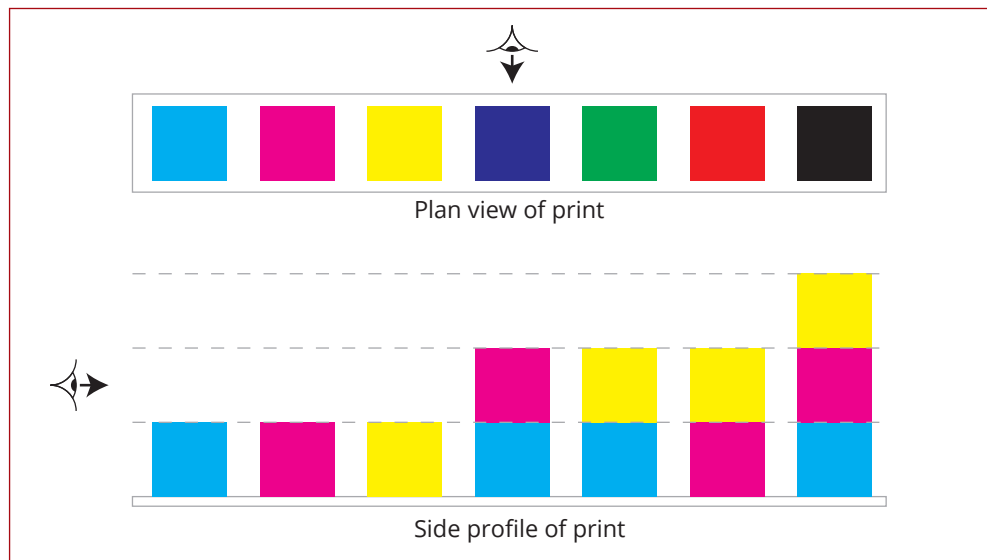

Figure 6.20 Side profile and plan view of tertiary colour mixing

A series of printing plates was designed to allow for a colour swatch test chart to be printed enabling flat deposits of colour to be printed on top of each other. The details of

the printing plate is presented in Appendix 6. A simplified breakdown of the method is depicted in the illustration below in figures 6.21 to 6.25. The initial colour to be cast is a solid white. This is the base layer and will become the substrate. It is cast with a printing lid that is a positive of the first printing colour. When cured this leaves a negative cavity to take the first colour ensuring a flat surface at the top. On this a flat layer can be flood cast at an even thickness. This ensures a flat surface from which the final layer can be cast so that a relief is produced on the upper surface.

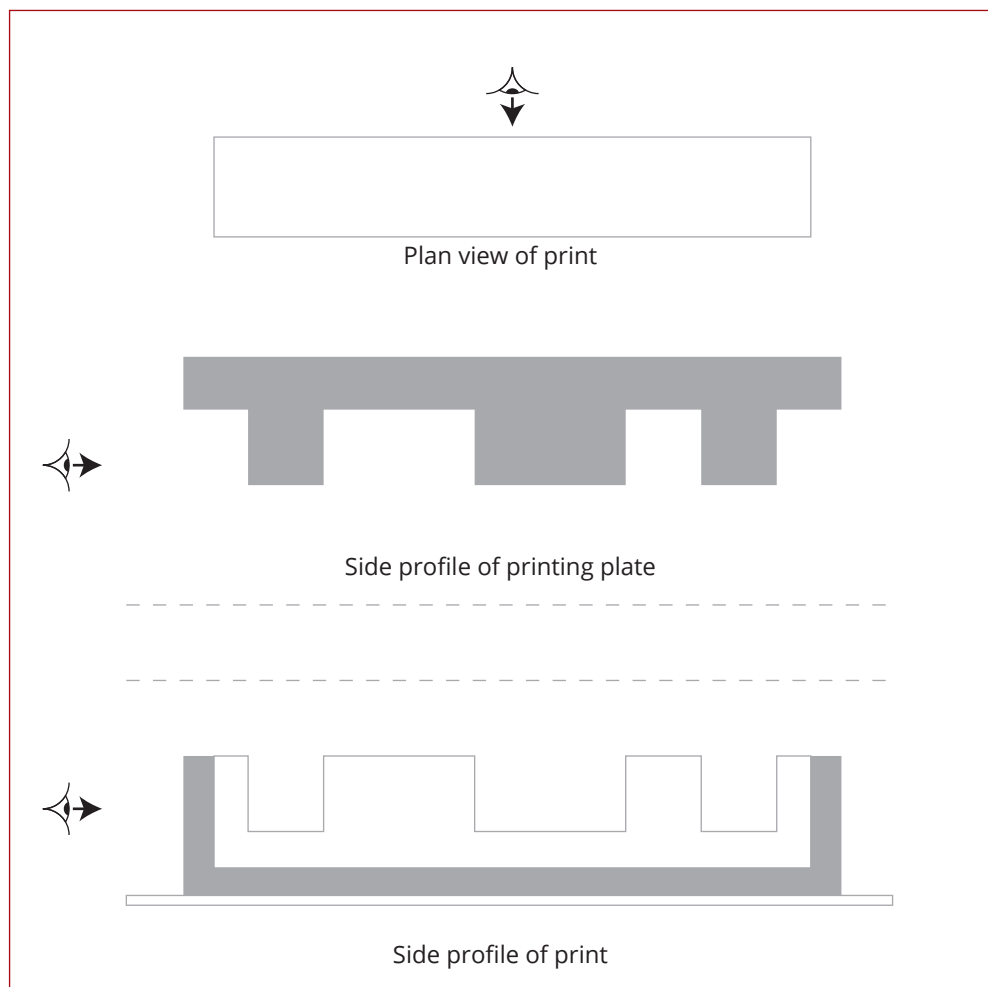

Figure 6.21 Step 1. The bottom printing plate remains in place throughout the process. An opaque mix of white silicone ink is poured into the mould and the 'positive' lid is clamped in place. Excess ink is displaced. Once cured the lid is removed to reveal the positive of the first image separation which can then be back filled with the initial colour.

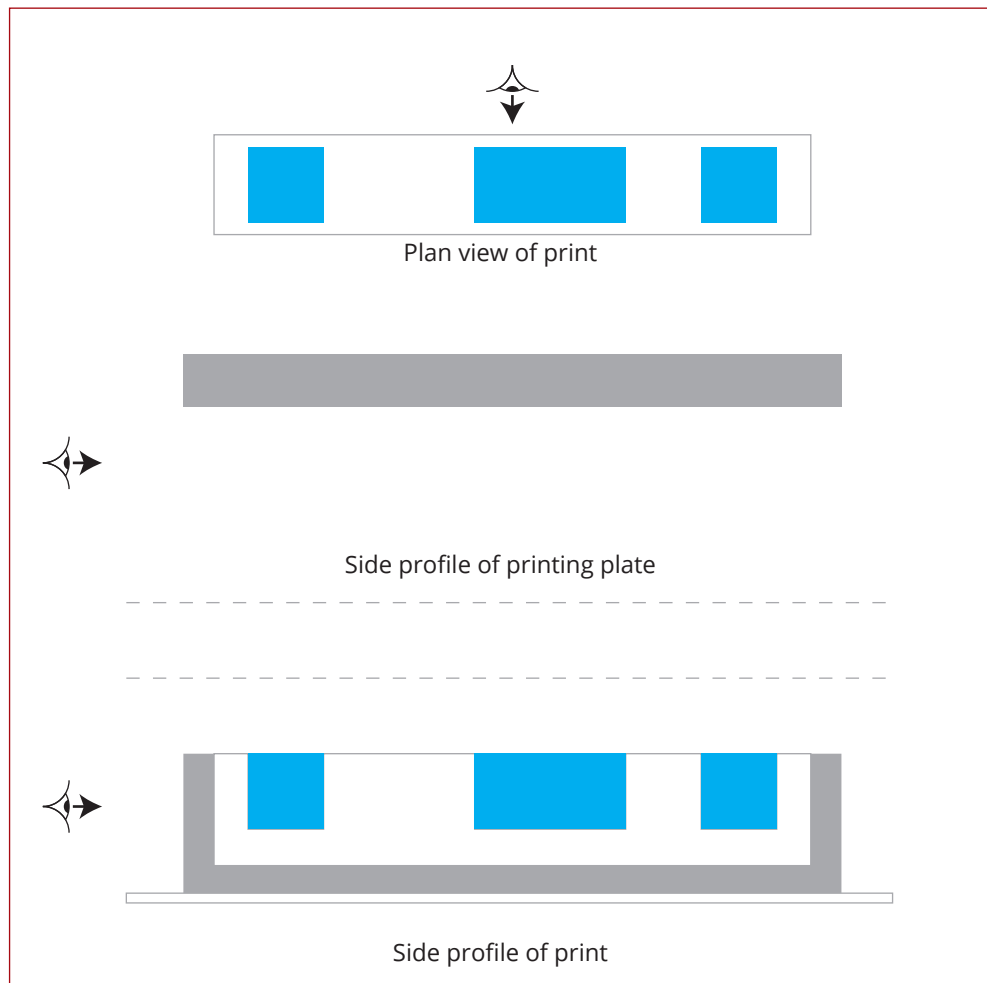

Figure 6.22 Step 2. The positive relief is infilled with the first separation colour and a flat lid is clamped shut displacing excess ink. When cured the lid and bottom plate is removed from the printing jig. The next separation plate is placed into the jig and is ready for the second colour to be applied.

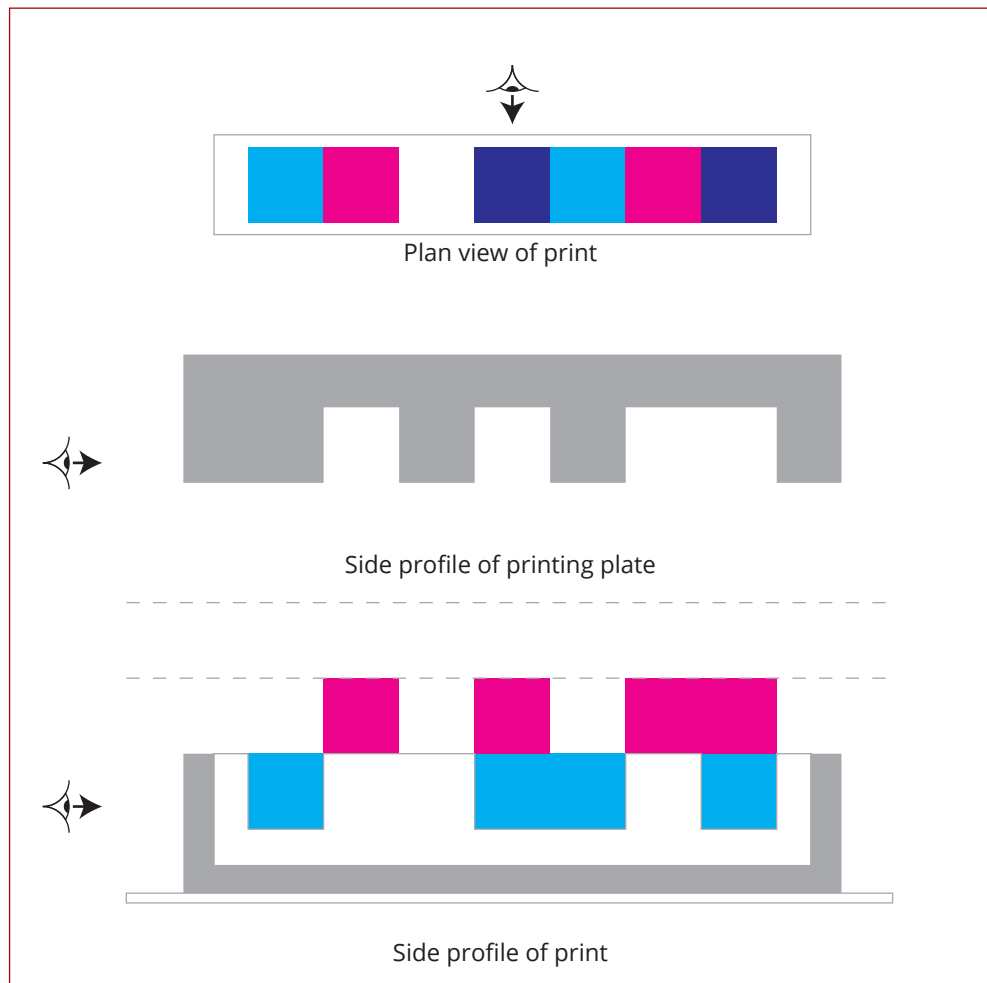

Figure 6.24 Step 3. The second colour is poured onto the plate. The opposite plate that contains the silicone cast of the substrate layer and the flat first colour are then placed on top to form the lid and are clamped shut. The excess ink is displaced. The silicone is left to cure. Once cured the plates are removed and can be separated. The image remains in the mould so that it stays in registration for the next colour to be applied.

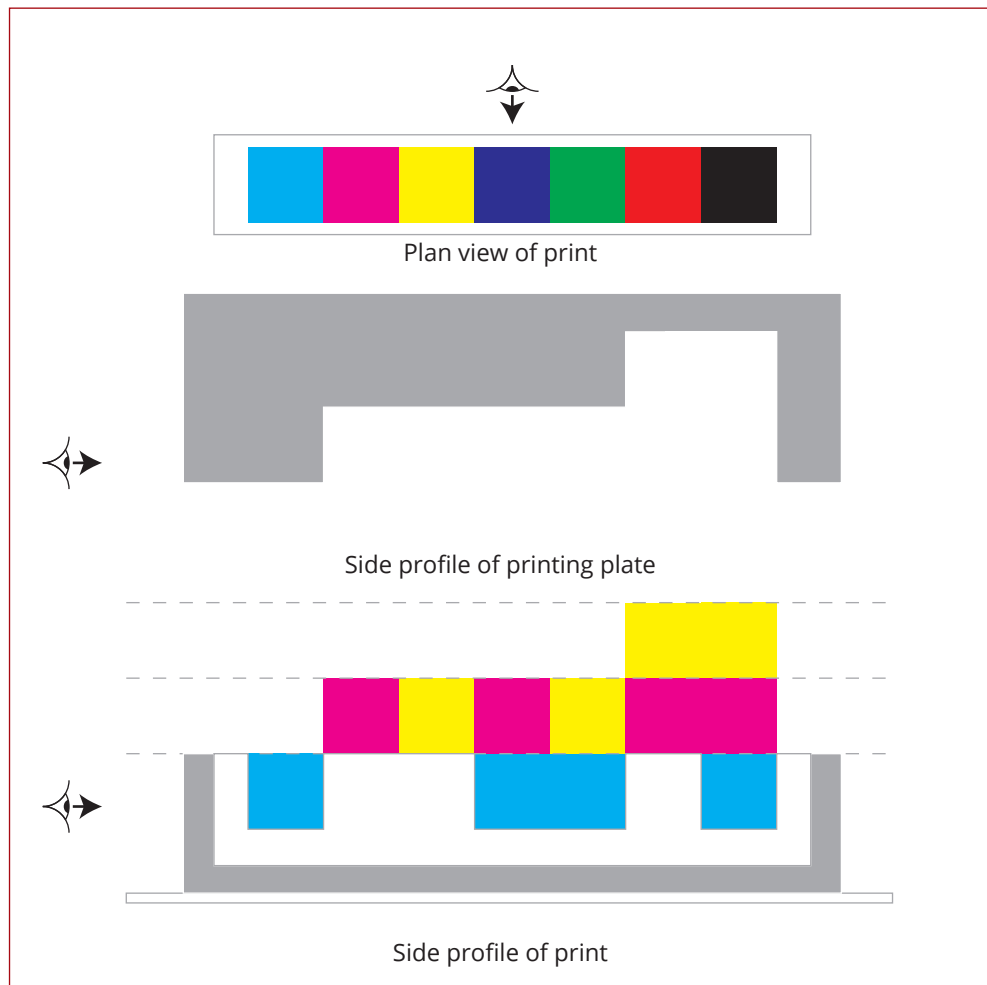

Figure 6.25 Step 4. The third and final colour separation plate is placed into the printing jig. The final colour is poured on top of the relief plate. The plate containing the image is placed into the jig and registered. Once registered clamp shut to expel any excess ink and leave to cure.

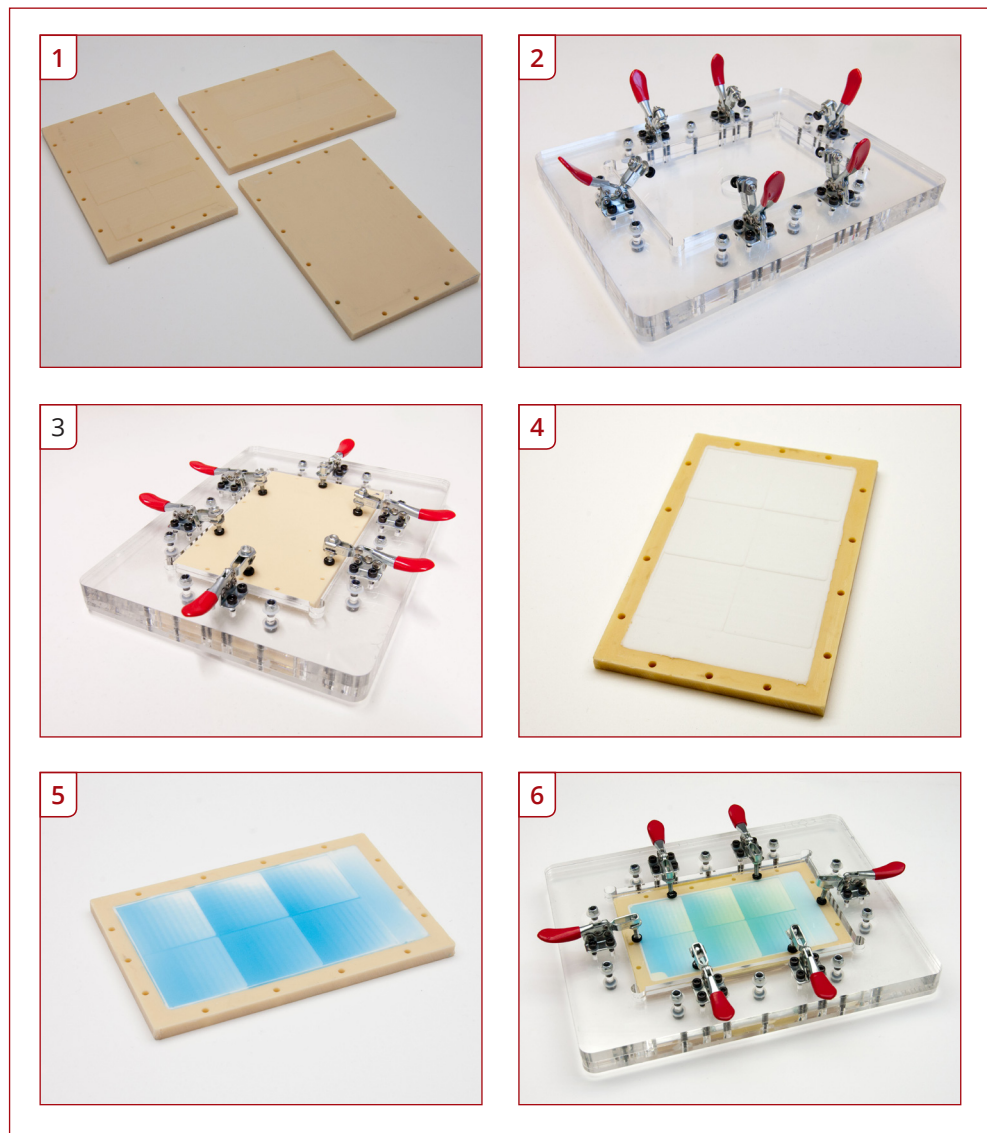

Figure 6.26 1) Printing plates. 2) Printing Jig with quick release clamps. 3) The print curing within the printing jig. 4) The white base layer cast with the negative cyan. 5) the cyan layer is cast. 6) The yellow layer during the curing process with a clear acrylic lid.

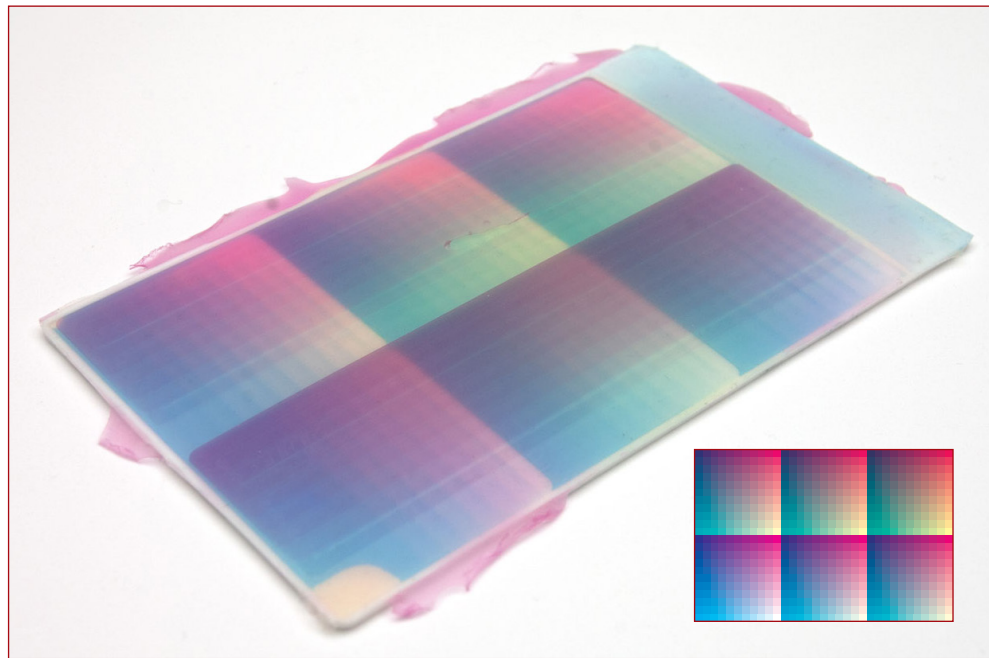

Figure 6.27 The final printed test swatch with the magenta layer as the final separation and the predicted test image (inset). Note the white area in the bottom corner of the swatch. This was caused by a bubble in the cyan layer.

6.4.1 Three colour swatch observations

The three colour print shown in figure 6.27 is faithful to the source image. There is no doubt that tertiary colours are being produced. Orange, purple and green hues are clearly visible and also in the expected places. The microscope image captures presented in figure 6.28 all show again that no half-tone patterns are contained within the prints and that they are continuous tone. This development in the empirical study improves upon the previous tests as it moves the investigation closer to achieving photo-realistic image rendering. This is explored in the next stage.

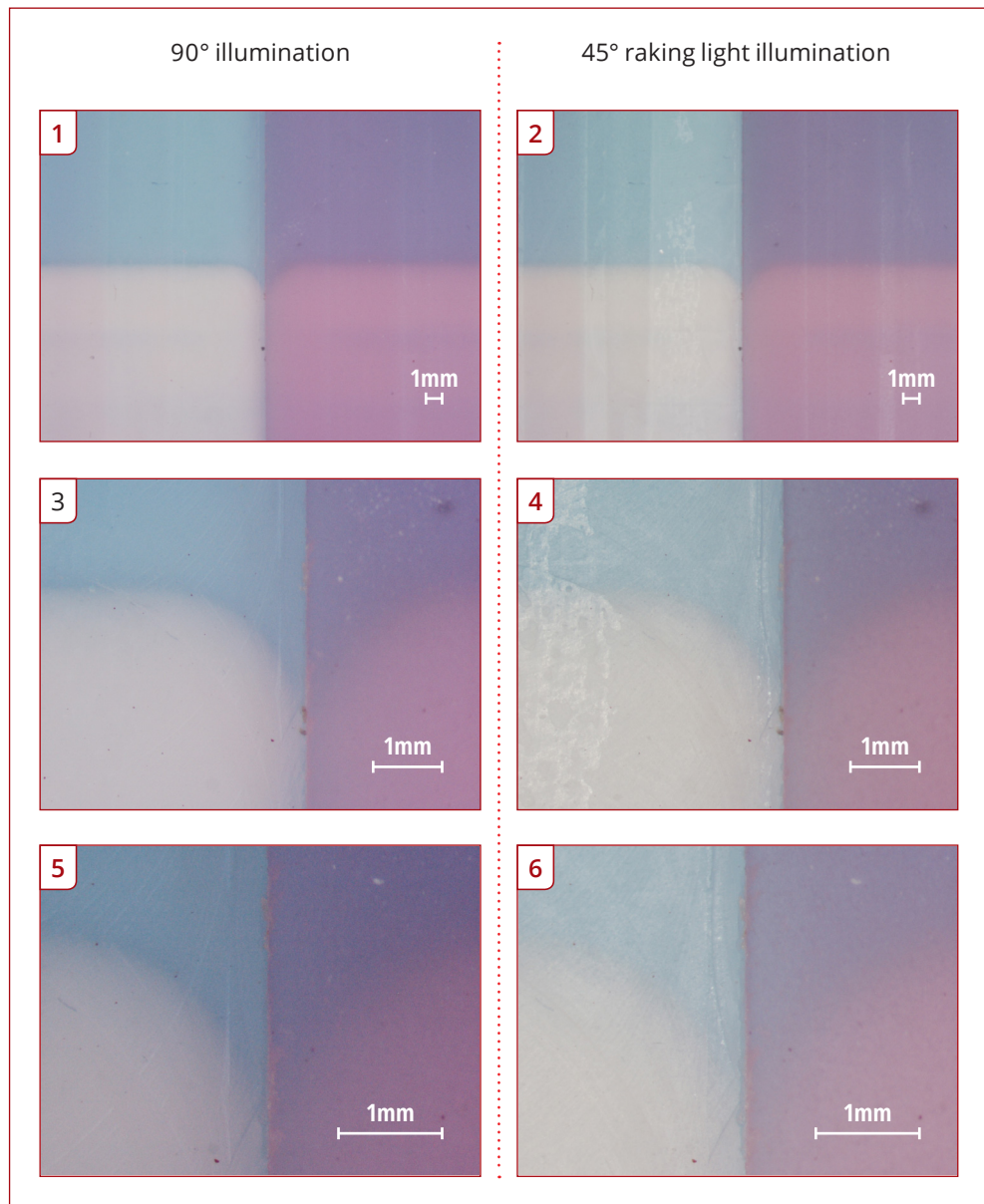

Figure 6.28 Microscope capture of the three colour print. Notice the lack of texture on the surface of the print due to it being cast as flat colours.

6.5 Photo-realistic rendering

A method of producing distorted relief printing plates was developed to enable photorealistic image printing. The printing plates are designed so that each successive plate is distorted by the relief of the previous separations that have been printed. This allows for the previous colour to be contained within the plate while leaving a cavity

with the correct relief detail for the next colour to be filled with the silicone ink. The exact separation method is described in Appendix 6, and a basic overview is presented below.

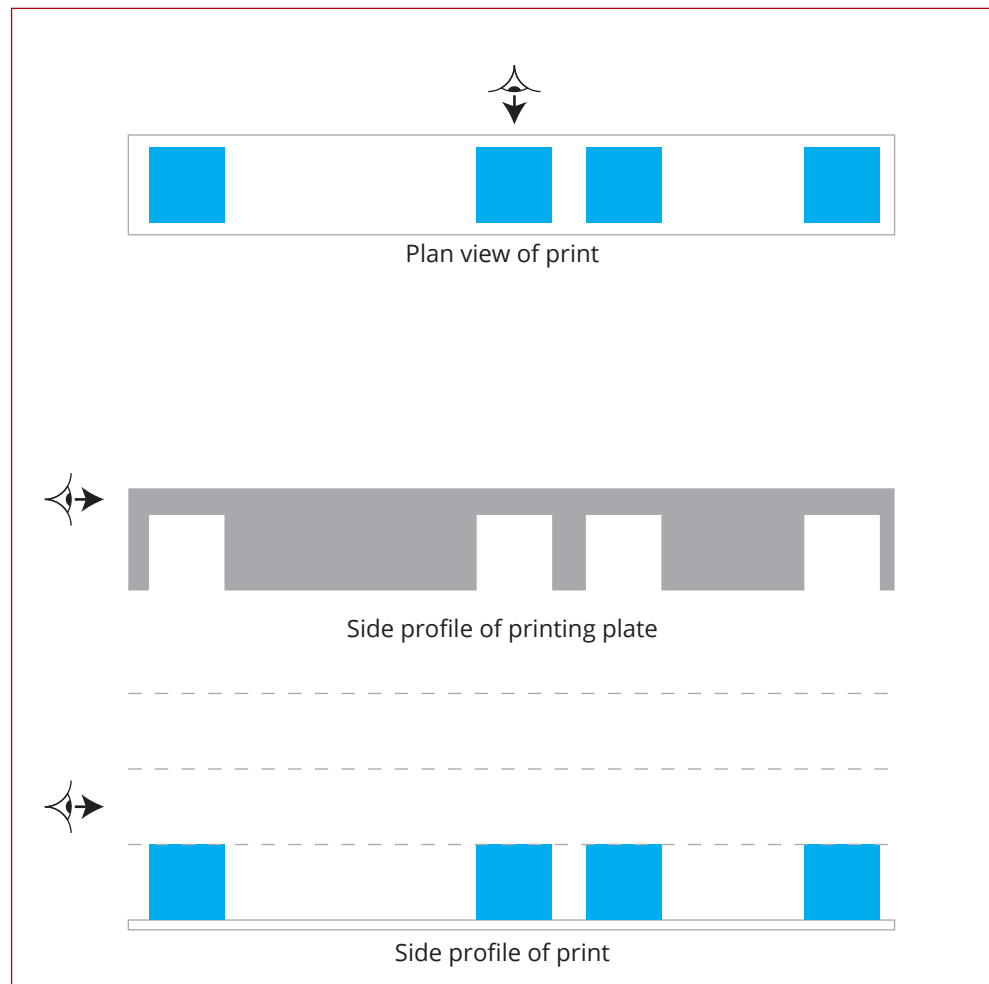

Figure 6.29 First height separation

The first relief printing plate is produced from a single colour separation by using a printing plate in exactly the same manner as a one colour silicone ink print.

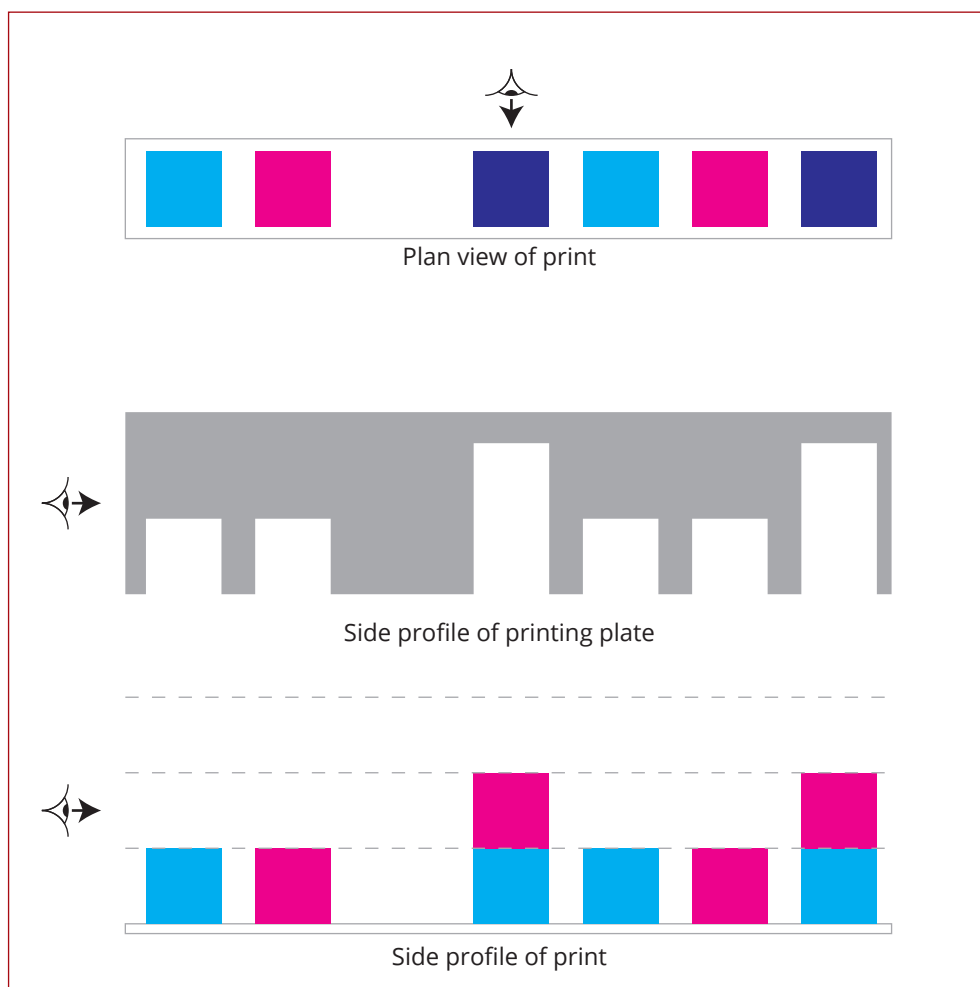

Figure 6.30 Second height separation

The next separation contains the relief information from the first ink colour deposition plus the additional relief of the second colour to be printed. The second relief printing plate is produced from a double separation of the first and second colours combined. It is overprinted on the previous separation.

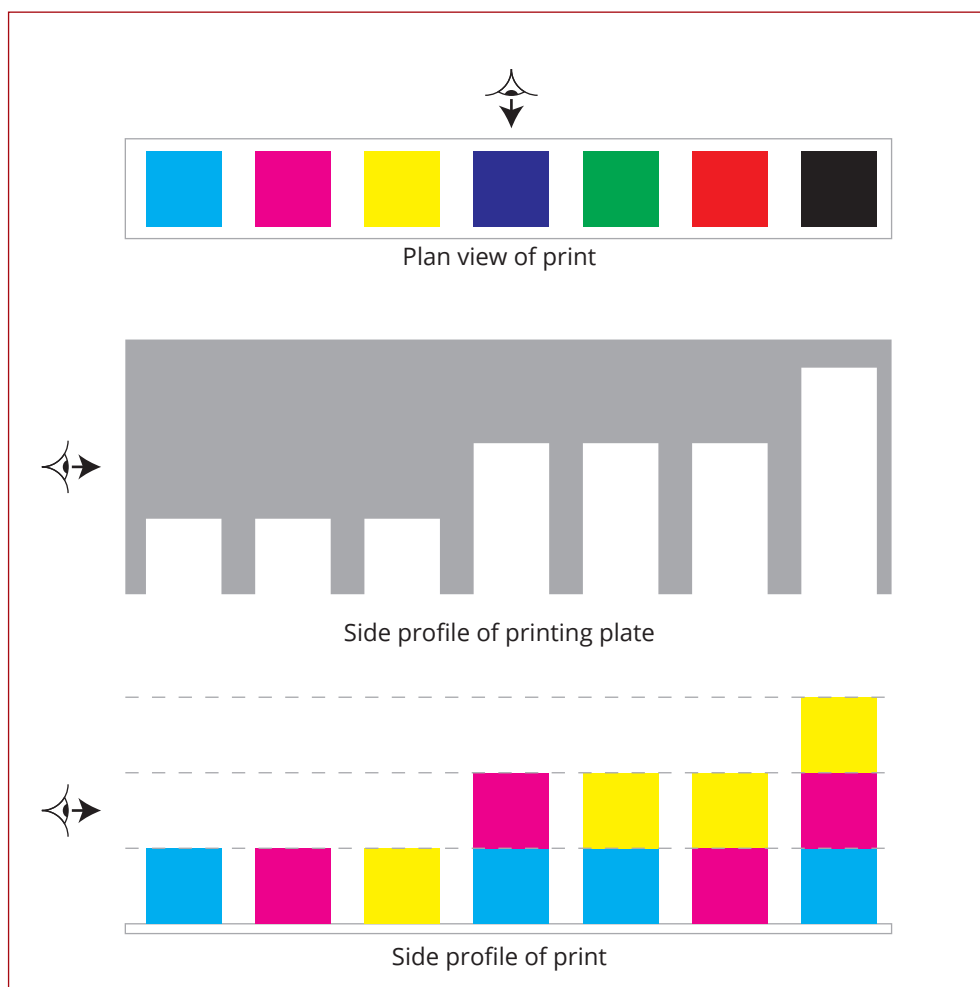

Figure 6.31 Third height separation

The third separation contains the relief information from the first two depositions plus the additional relief of the third colour to be printed. This printing plate is produced from a triple separation of the first, second and third colours combined including the tonal ranges of all three separations. By producing the printing plates in this manner it allows the plates to interlock with the print and build on the previous ink layers. The renderings in silicone had the ability to make separations that were able to go above and below the level of the substrate surface. As the base layer could be cast thicker this allowed the first layer to be cast into the substrate and the remaining layers to be cast on top of the substrate layer.

6.5.1 Tri-chromatic photo-realistic renderings in silicone

This method of image separation generation is based on the following notion; each separation must consist of a greyscale image channel that has a tone range of 0% to 100%. Each subsequent printing plate separation must include the tonal information from the previous separation layer plus its own additional individual tonal information. The depth of the relief in each separation printing plate must take into account the previous layers. As such as each colour is deposited, the relief is greater to accommodate this distortion. The relief produced in the printing plate is directly proportional to the number of printed colours that precede it, ie the relief gets deeper as the number of colours increases. Combination printing plate separations must be generated using the linear burn layer blending mode in Adobe Photoshop. This layer blending mode combines the total grey values up to a maximum of 100% while keeping white transparent. Therefore the total grey values of the combined separations must total 100%.

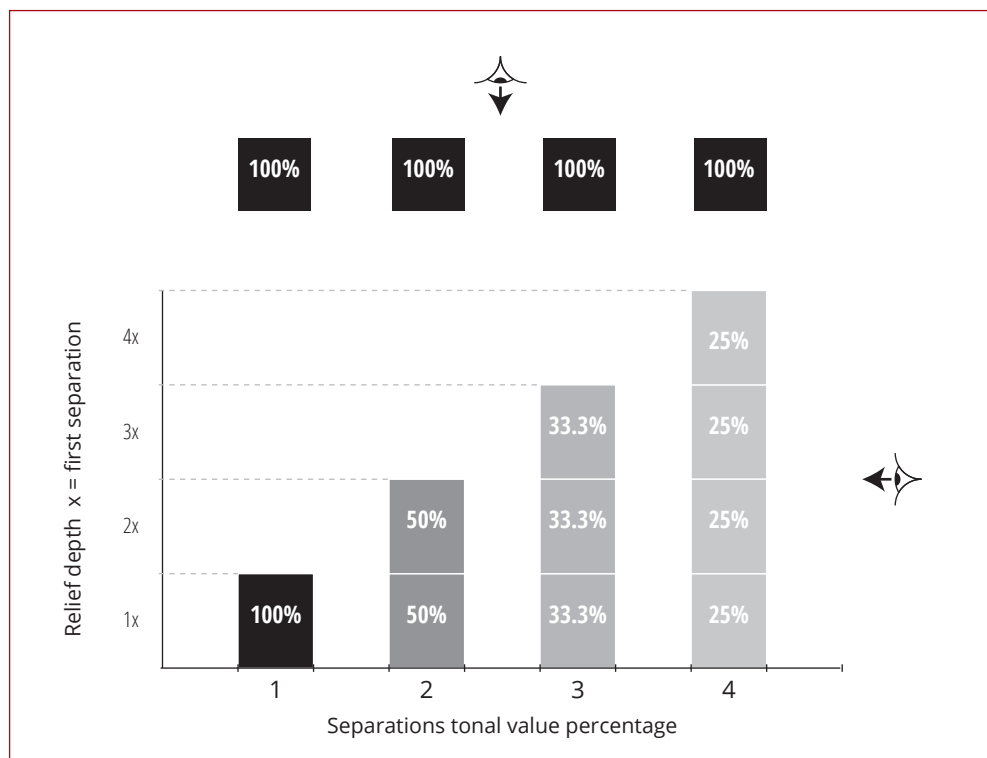

Figure 6.32 Polychromatic relief generation

The number of channels used to make the printing separation is the denominator of the vulgar fraction that determines the opacity value of each channel layer. The number of channels in the separation is also used to specify the multiplier value of the

relief height-map x . For example if each layer is printed at 1mm (x) in depth then the separations can be calculated as follows:

1 channel = 1/1 grey value (100%) with a relief height of 1mm (1x)
 2 channels = 1/2 grey value (50%) each with a combined relief height-map of 2mm (2x)
 3 channels = 1/3 grey value (33.3%) each with a combined relief height-map of 3mm (3x)
 4 channels = 1/4 grey value (25%) each with a combined relief height-map of 4mm (4x)
 and so on.

Therefore the first layer will consist of a single colour separation. It will have a tonal range of values from 0% to 100% and have a relief height-map of 1x.

The second layer will consist of a double separation containing 2 individual separations with values ranging from 0% to 50% each. When the values are combined together they have a total tonal range from 0% to 100% and have a combined relief height-map of 2x.

The third layer will consist of a triple separation containing 3 individual separations with values ranging from 0 to 33 $\frac{1}{3}$ %. When the values are combined together they have a total tonal range from 0% to 100% and have a combined relief height-map of 3x.

A quadruple separation will consist of 4 individual separations. The final separation will consist of 4 separations with grey values ranging from 0% to 25% respectively. When the values are combined they have a total tonal range from 0% to 100% and have a combined relief height-map of 4mm.





Primaries per separation				
	1	2	3	4
Separation Layer Linear Burn Mode	100%	50%	33.3%	25%
		50%	33.3%	25%
			33.3%	25%
			33.3%	25%
Scale factor for relief height in Z axis	100%	200%	300%	400%

Table 6.1 Image separation reference table.

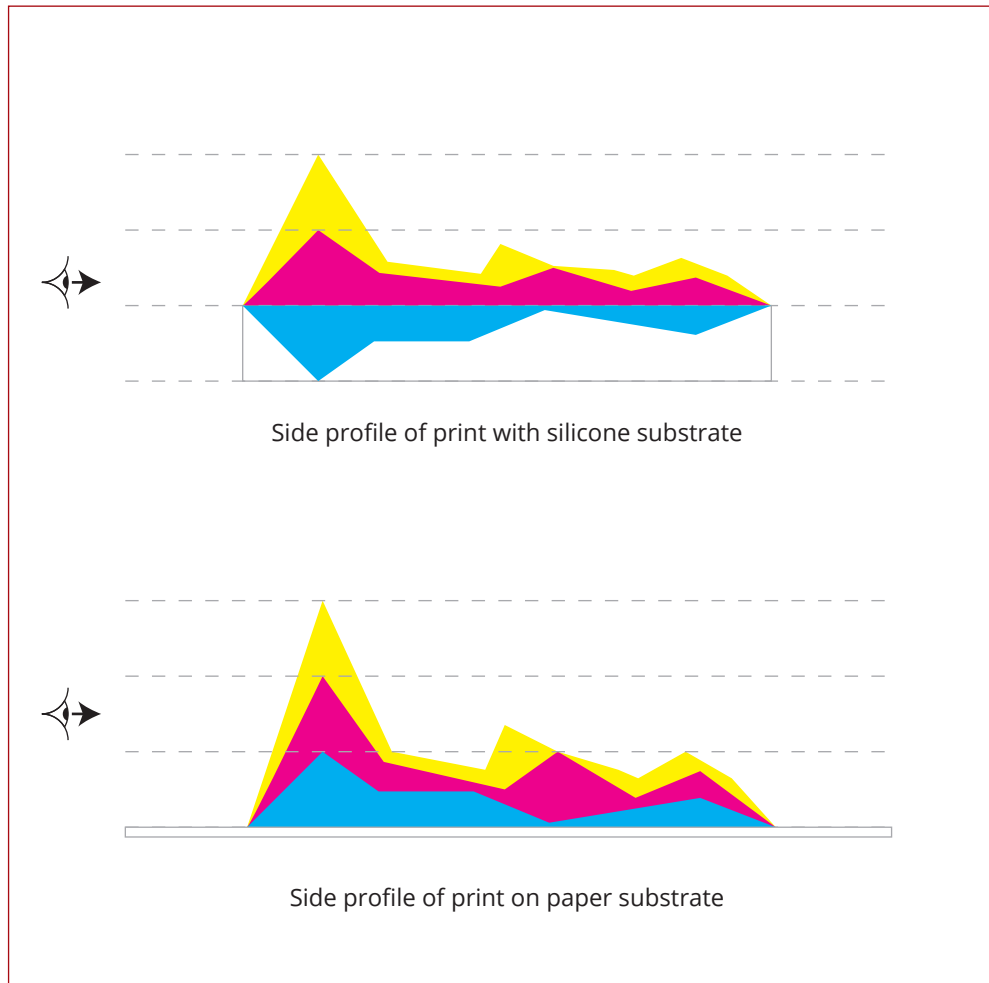

Figure 6.33 This image illustrates how the colour separations can be developed to layer downwards into a silicone substrate or layered on top of each other for a paper substrate.

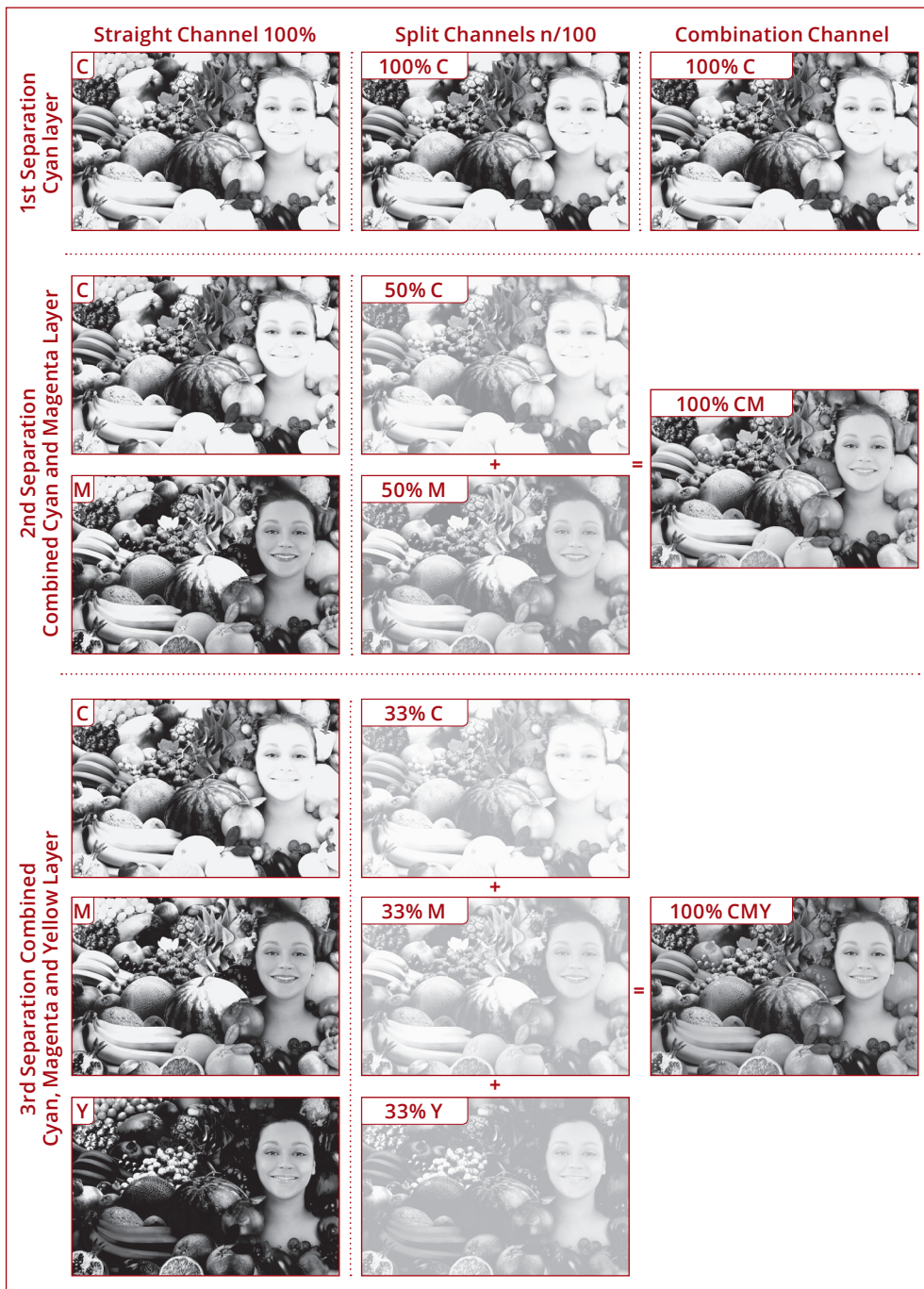

Figure 6.34 Illustration depicting how each deformed separation plate is made by combining print channels through a linear burn.

6.6 Results of tri-chromatic photo-realistic rendering in silicone

6.6.1 Results of tri-chromatic photo-realistic rendering in silicone

The silicone printing was successful in registration and in layering colour depositions. The images when printed were flexible and could be stretched, twisted and crumpled and upon release would return to their original shape. As they were printed with a silicone they could be submerged in water and withstand rough handling that would otherwise damage prints on paper. As the silicone can be pigmented the images can also be printed into a clear silicone substrate which produces completely different visual results.



Figure 6.35 3 Colour print released from printing plates and printed into a white silicone substrate.



Figure 6.36 The silicone prints are flexible and can be stretched and distorted.

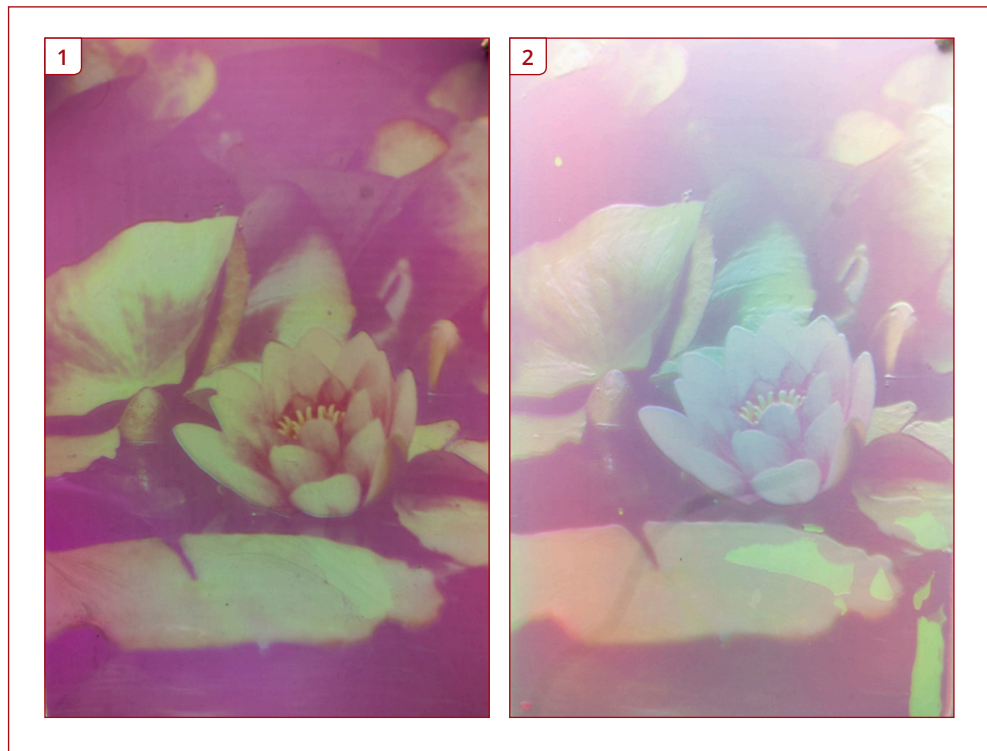

Figure 6.37 The same image is printed on white silicone (1) and again in clear silicone (2) both images are backlit.



Figure 6.38 1) Printed on white silicone and backlit. 2) Printed on clear silicone and backlit.

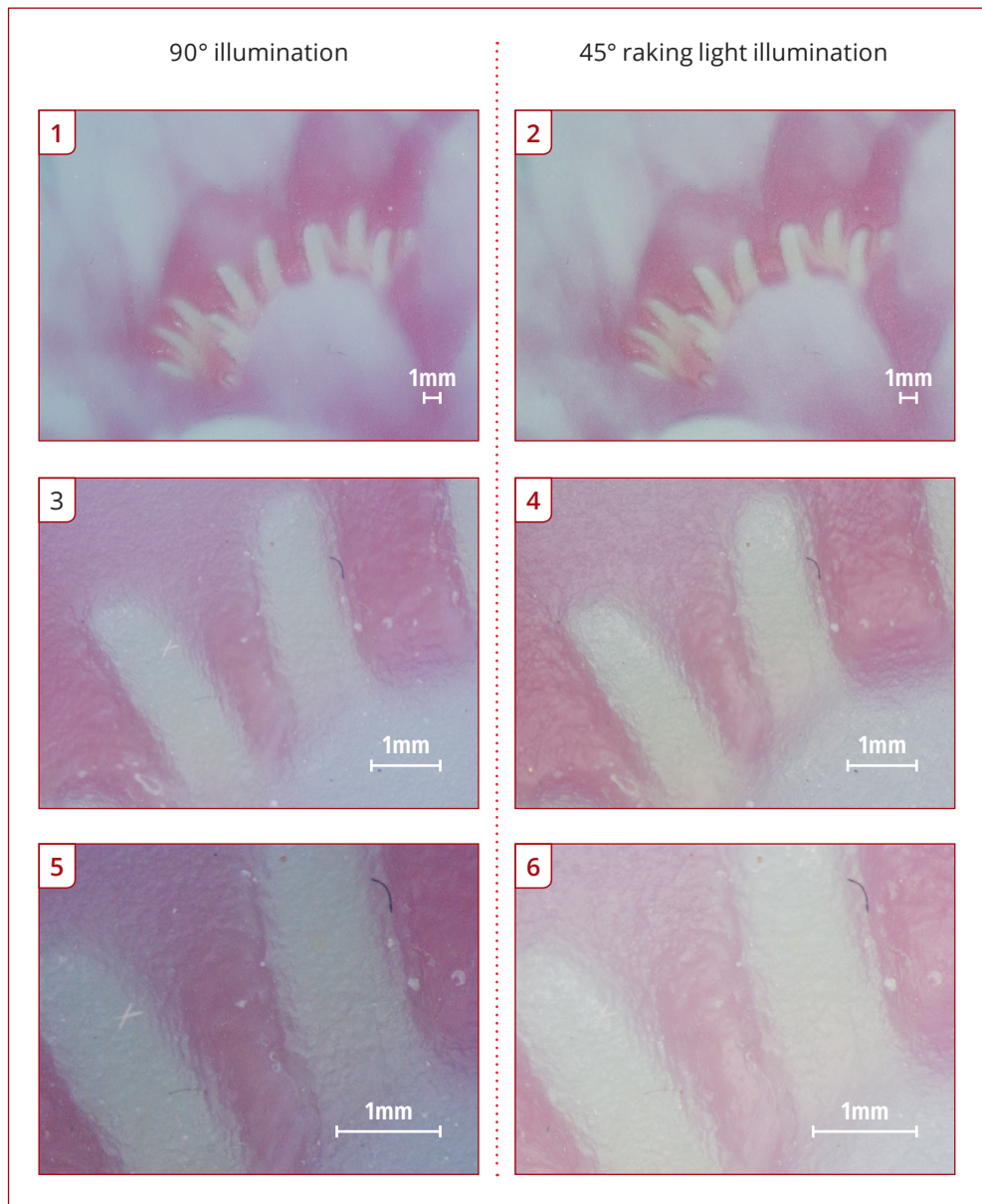

Figure 6.39 Stamen of water-lily. Each magnification is paired with the same scene illuminated and illuminated with a raking light.

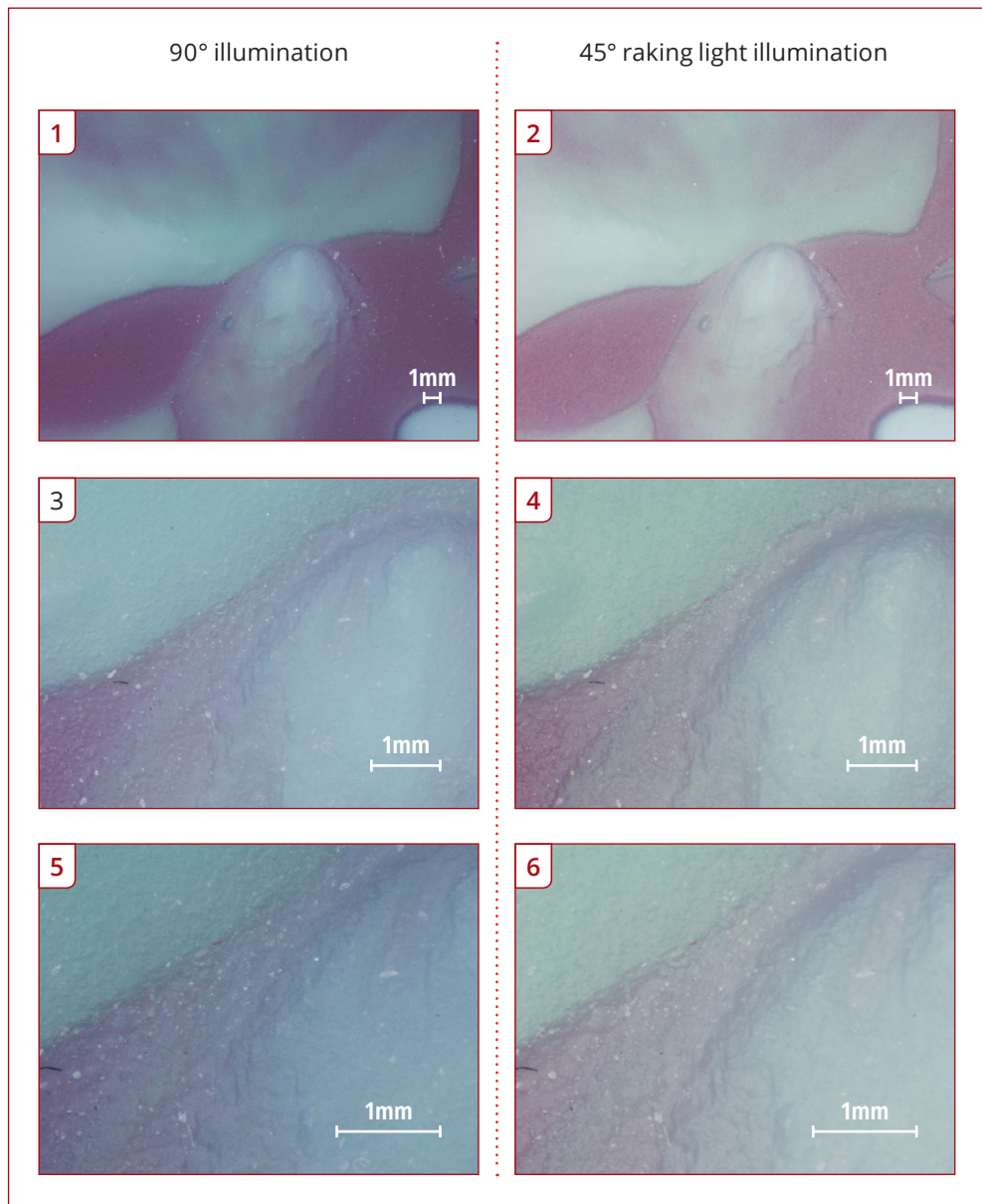

Figure 6.40 Lilly-pad of water-lily. Each magnification is paired with the same scene illuminated and illuminated with a raking light.

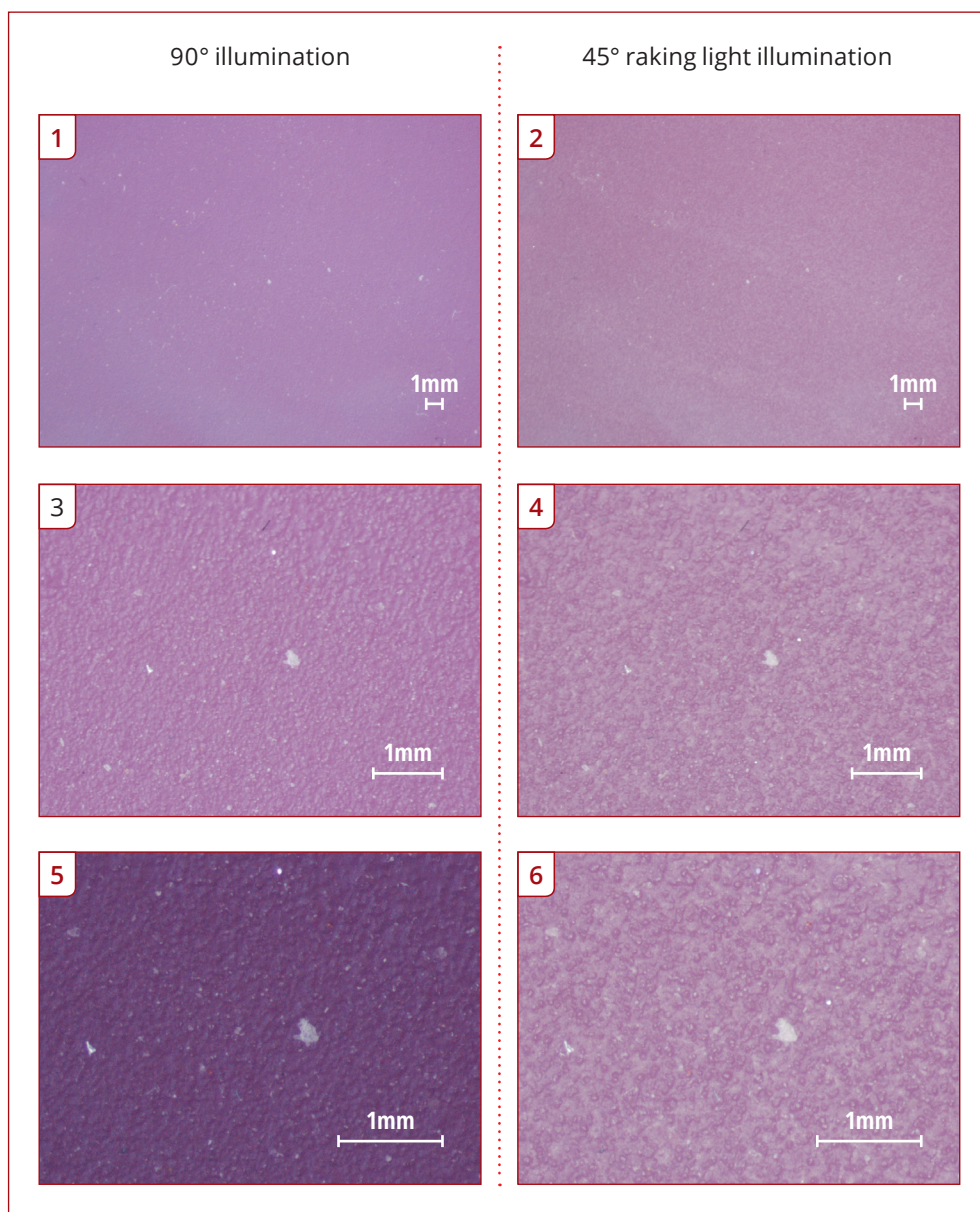

Figure 6.41 Dark water. Each magnification is paired with the same scene illuminated and illuminated with a raking light.

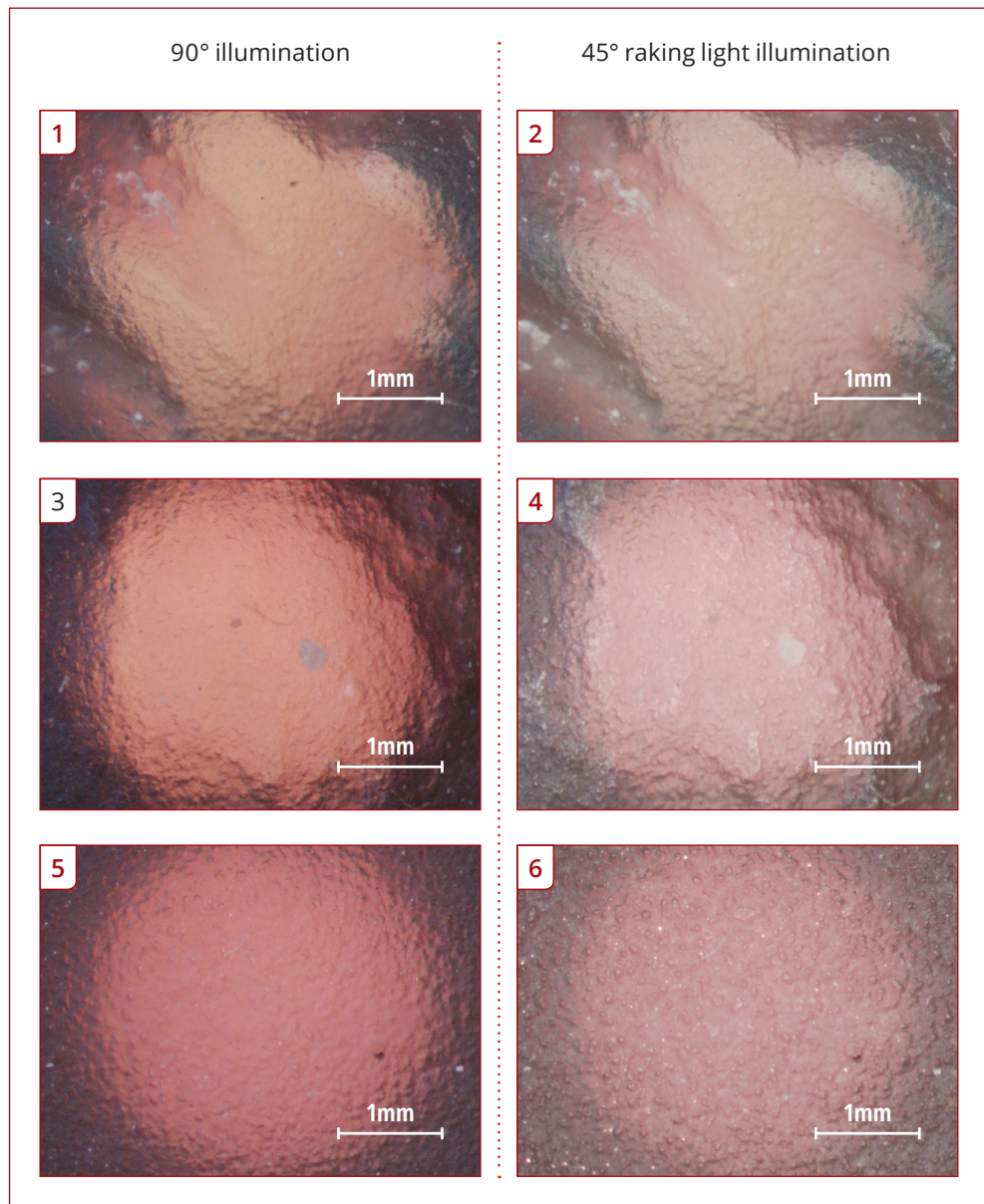

Figure 6.42 1-2) Stamen of water-lily backlit and printed on clear silicone.
 3-4) Lily-pad of water-lily backlit and printed on clear silicone.
 5-6) Dark water of water-lily backlit and printed on clear silicone.

6.6.2 Children's toy owl image

The next series of images is of a child's toy. It contains a wider range of hues and textures and colour mixing is more apparent.

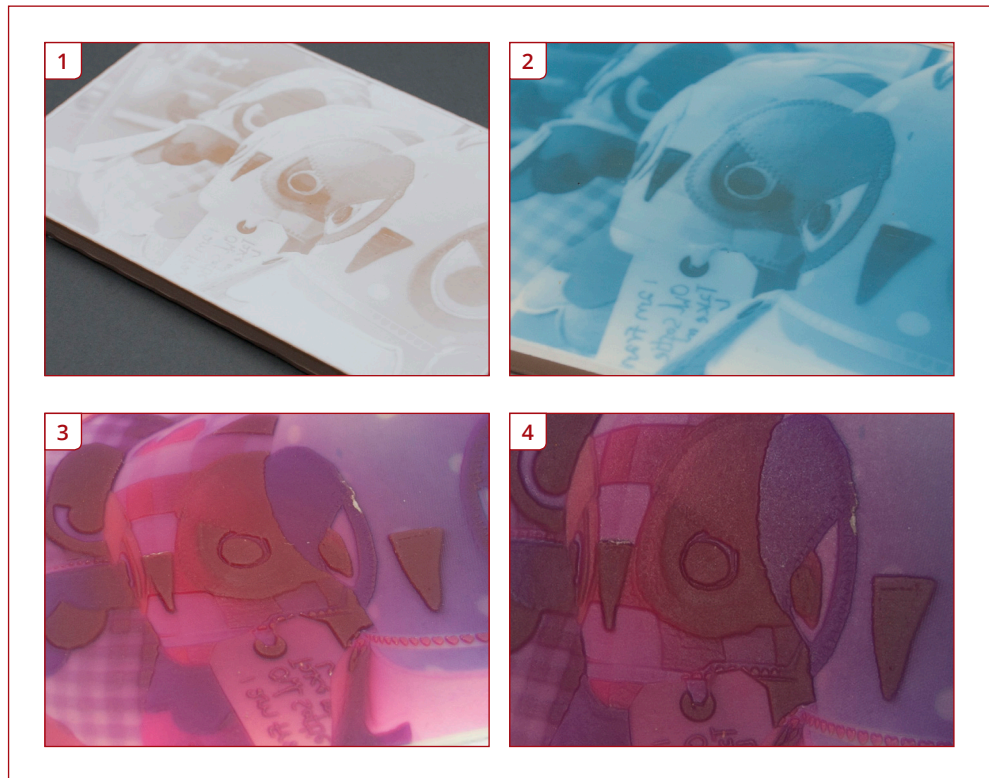

Figure 6.43 1) The positive first colour is moulded into the base substrate. 2) The cyan layer is in-filled and cured. 3) The magenta layer is cured and secondary colours are visible. 4) Close-up.



Figure 6.44 Yellow layer added to the owl image. Texture is very visible on the patchwork.



Figure 6.45 When back illuminated the image takes a completely different appearance. Secondary and tertiary colour mixing is visible within the image. There is an amount of faithfulness to the reproduction.



Figure 6.46 The original source image.

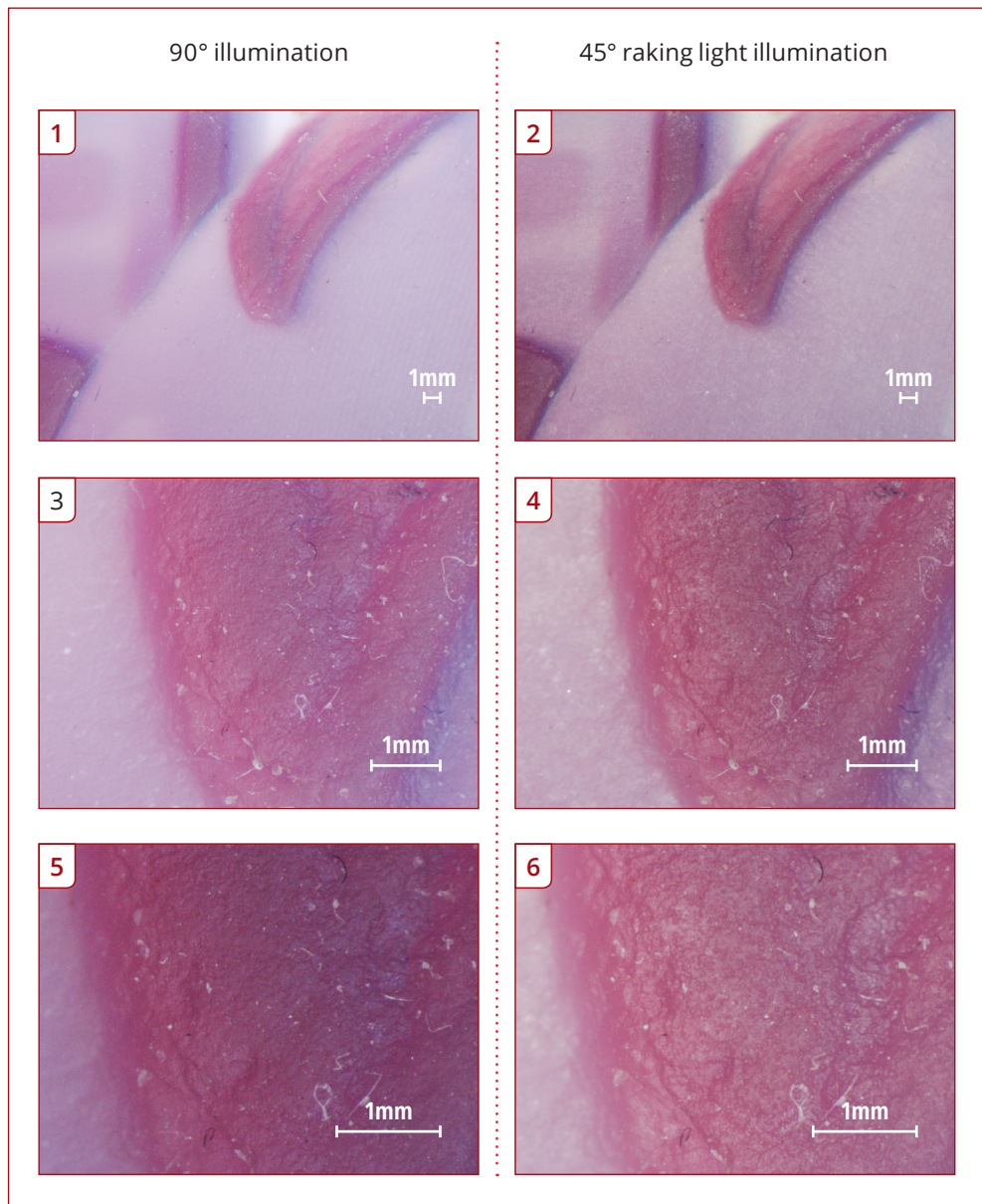

Figure 6.47 Owl's head and feather tuft. Each magnification is paired with the same scene illuminated and illuminated with a raking light.

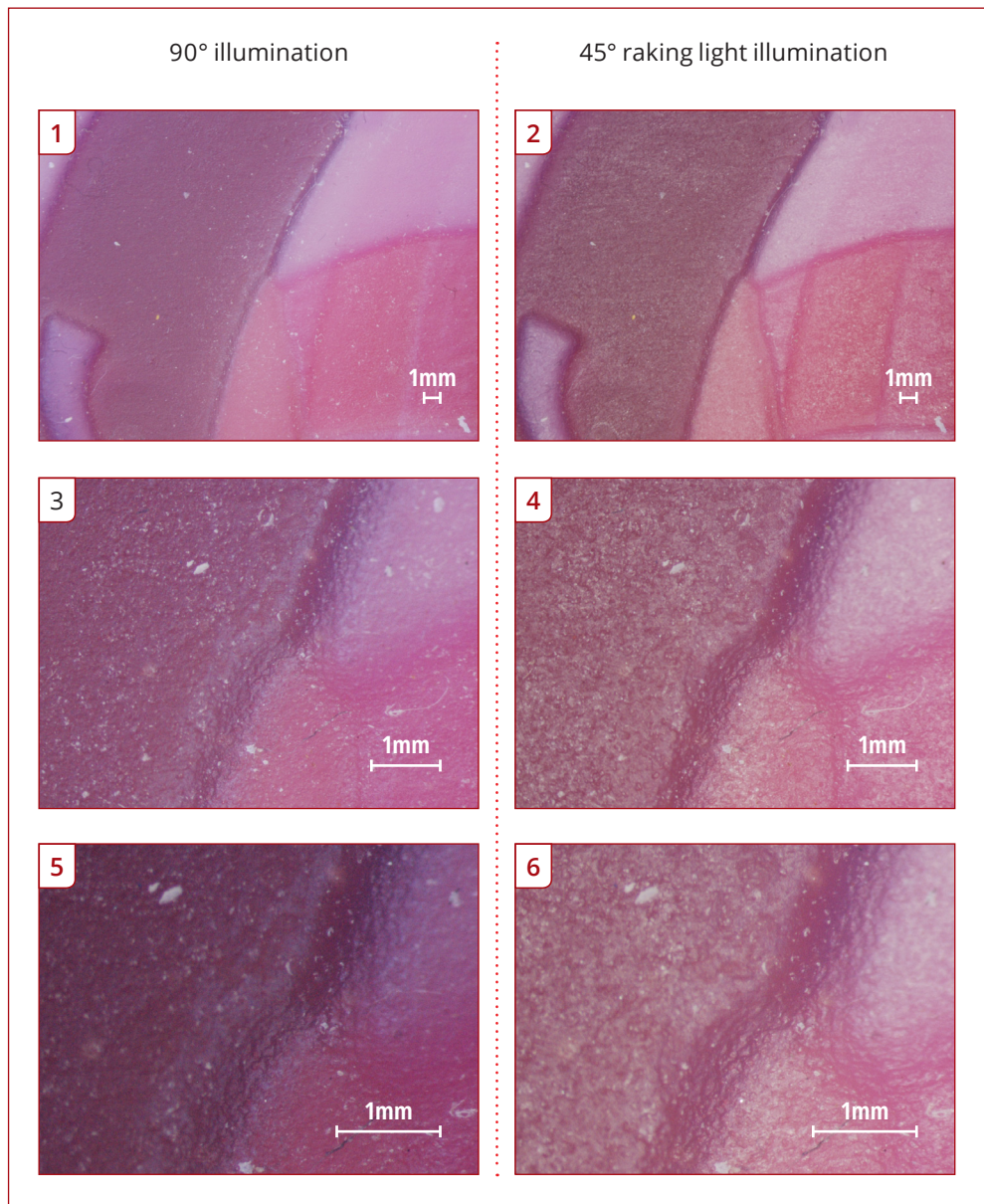

Figure 6.48 Owl's eyes. Each magnification is paired with the same scene illuminated and illuminated with a raking light.

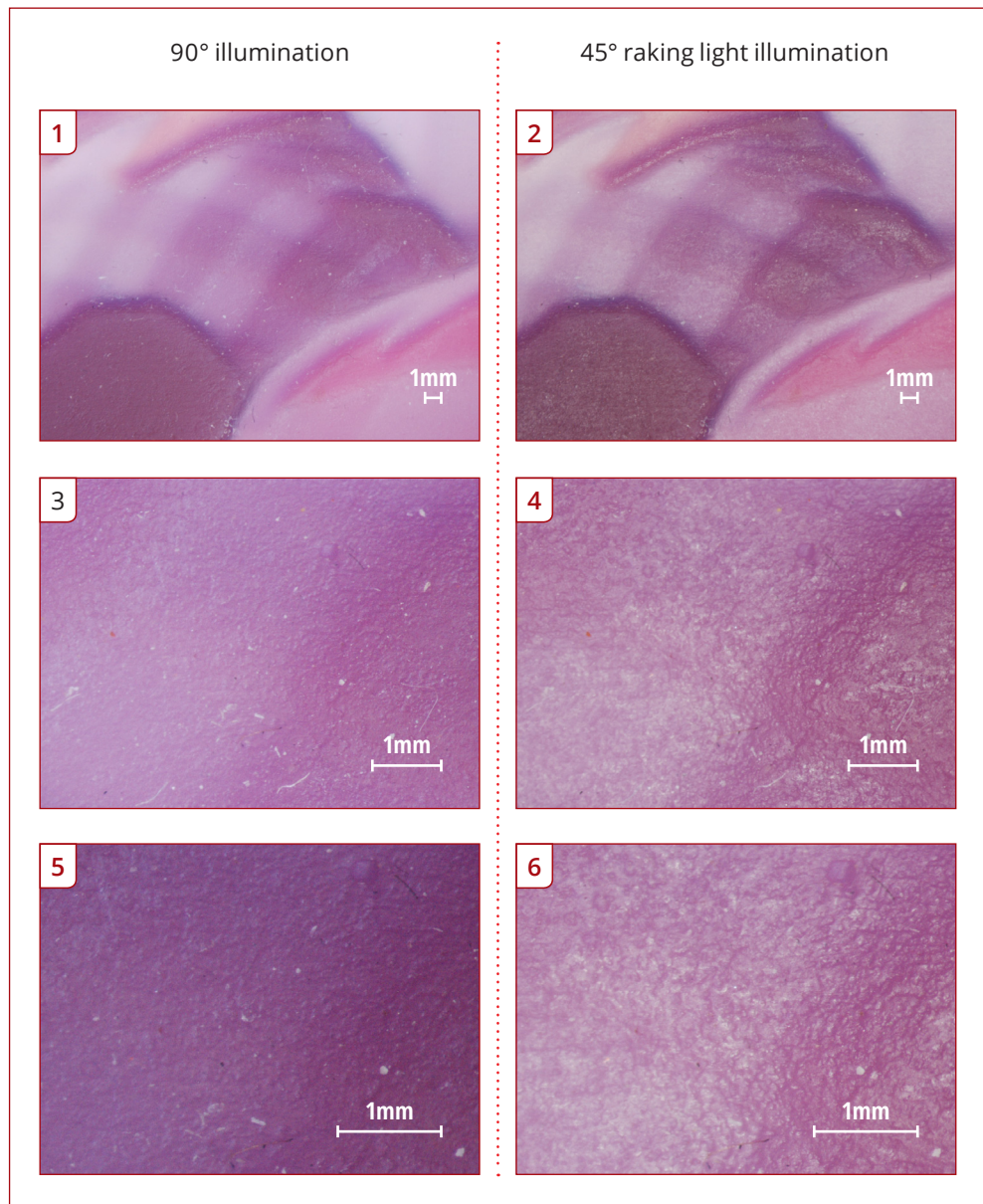

Figure 6.49 Gingham fabric. Each magnification is paired with the same scene illuminated and illuminated with a raking light.

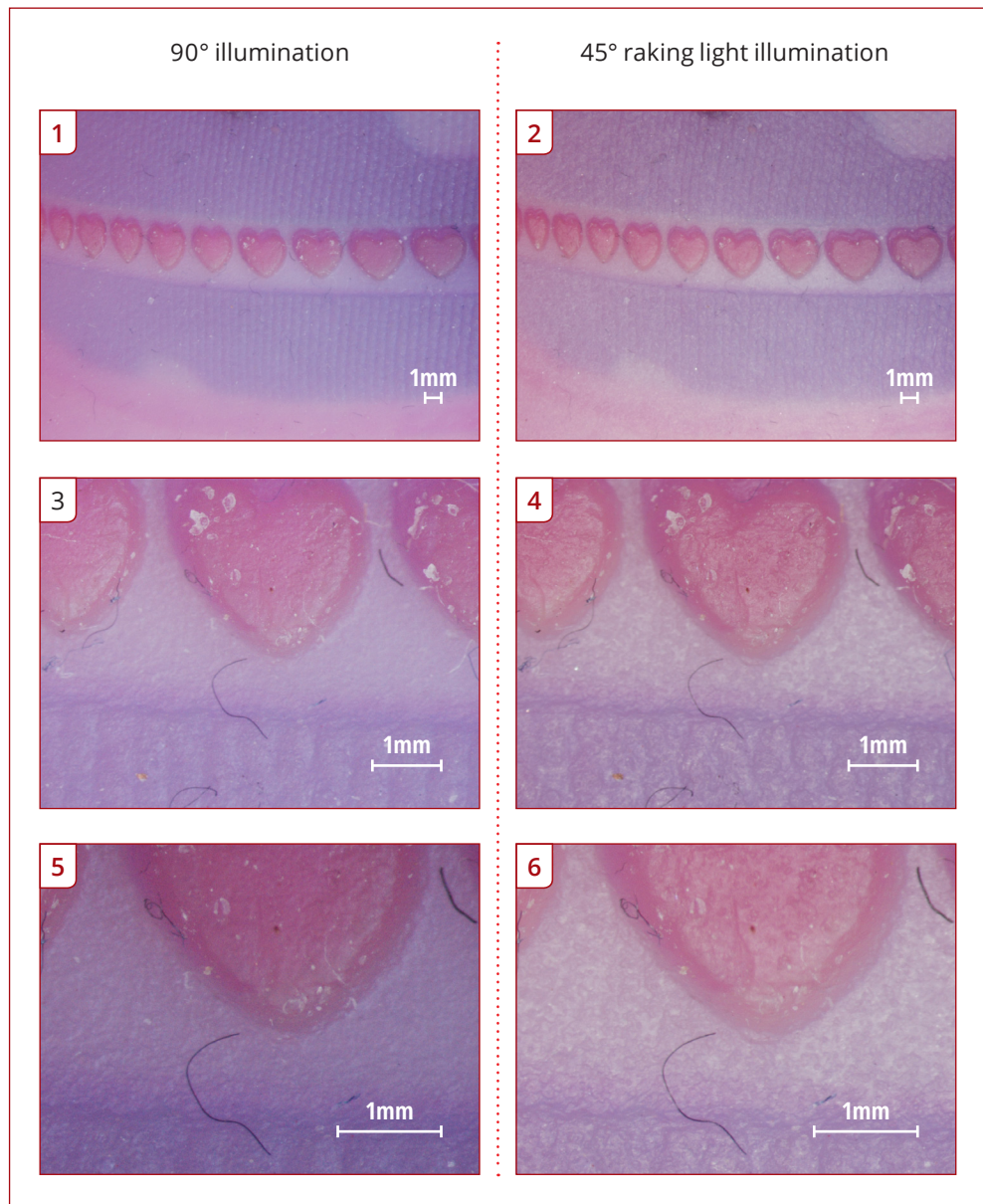

Figure 6.50 Heart ribbon. Each magnification is paired with the same scene illuminated and illuminated with a raking light.

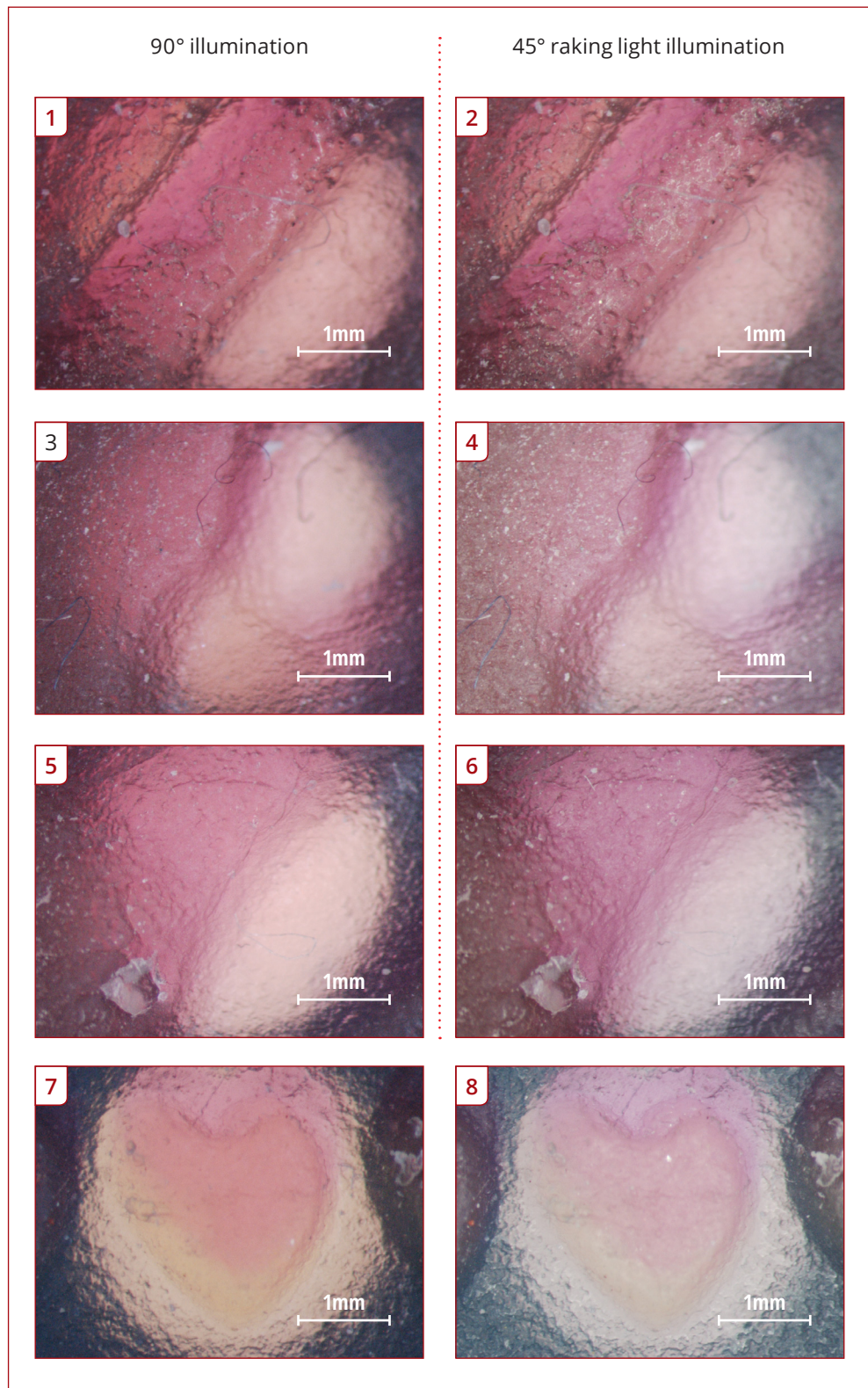

Figure 6.51 The children's toy owls were printed onto a clear silicone base and microscope captures taken. 1-2) Owl's head 3-4) Owl's eyes 5-6) Gingham fabric 7-8) Heart ribbon

6.7 Re-evaluation of the Digital Woodburytype model to a polychromatic process

The research has demonstrated that colour continuous tone printing is achievable with a silicone ink, using surface topography to change the hue and tone. This final part of the research re-addresses the Woodburytype process itself and presents the development of two methods that allow for image registration and photo-realistic printing of images in colour.

6.7.1 Silicone printing plates

From the initial method of CNC milling single colour Woodburytypes the substrate used required sealing. This while somewhat successful also removed some detail. A 70 Shore D silicone was used to take a cast from the milled mould and from this an impression could be made. This served two purposes. The time taken to CNC mill a 6x4in printing plate was 16 hours. Additional plates would also take the same time. The silicone cast takes 20 minutes to cure. From one initial milling multiple casts can be taken. As the silicone has the added benefit of being easy to clean and it does not need sealing. Additional tests using electroforming also enabled metal plates to be produced. Details of the silicone casting and electroforming is listed in Appendix 6.

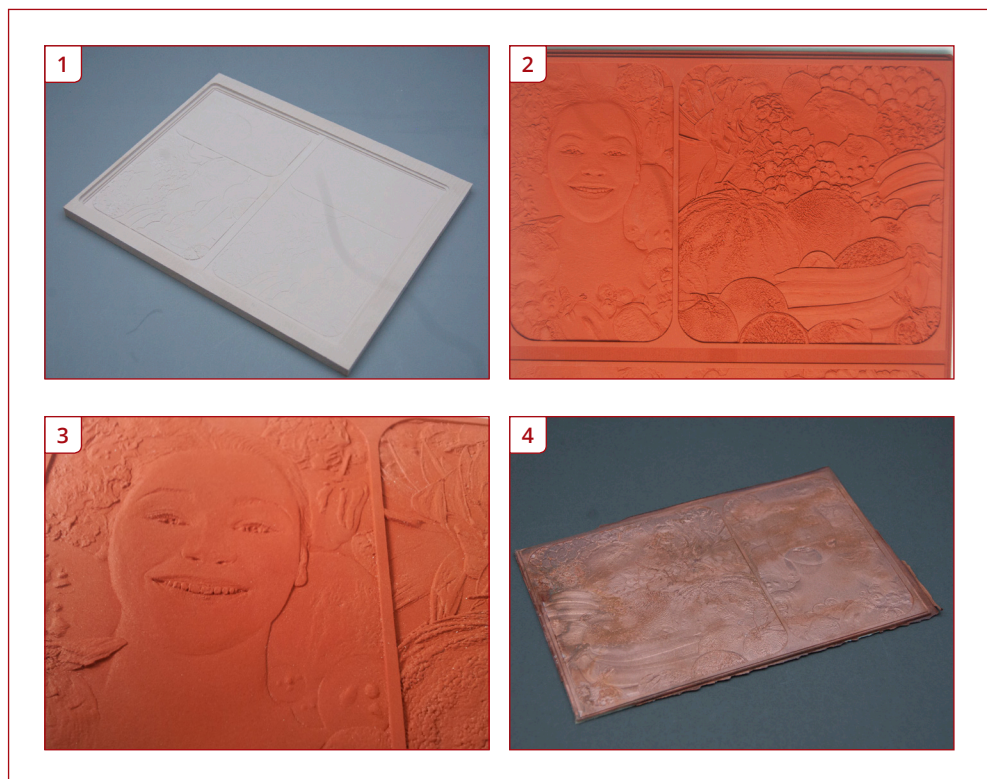

Figure 6.52 1) Positive CNC milled board 2) Negative silicone cast plate. 3) Detail of silicone plate. 4) Electroformed printing plate from silicone matrix.

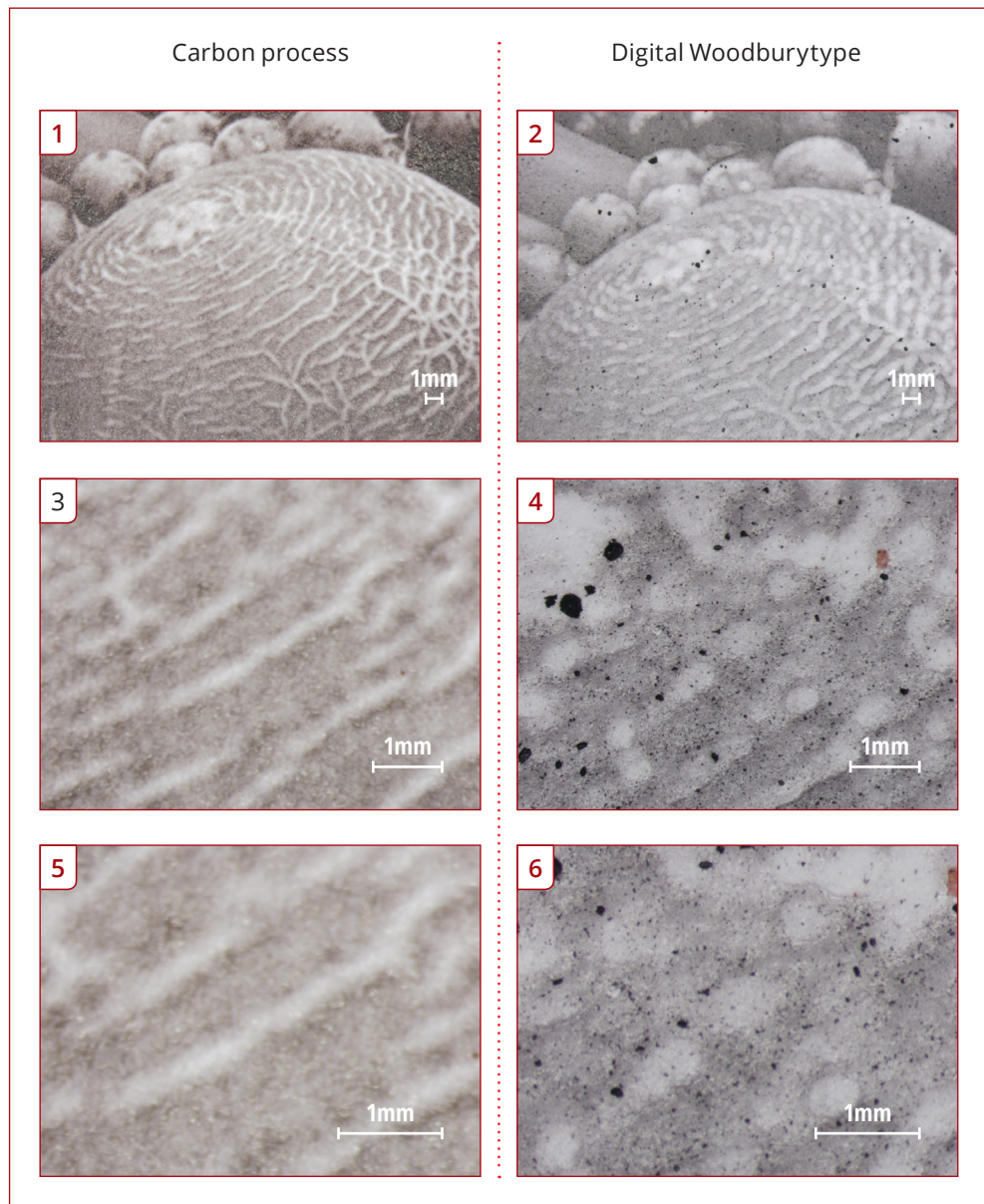

Figure 6.53 Comparison of Carbon process print to a digital Woodburytype print from a silicone printing plate. (Note: Ink was spilled on the Woodburytype image after it dried, these are the large black particles on the print and should be ignored in the comparison).

Comparisons of Carbon Process prints and digital Woodburytype images are almost identical under microscope inspection in Figure 6.53. There is a very slight softening of the image on the CNC milled print due to cutter step-over.

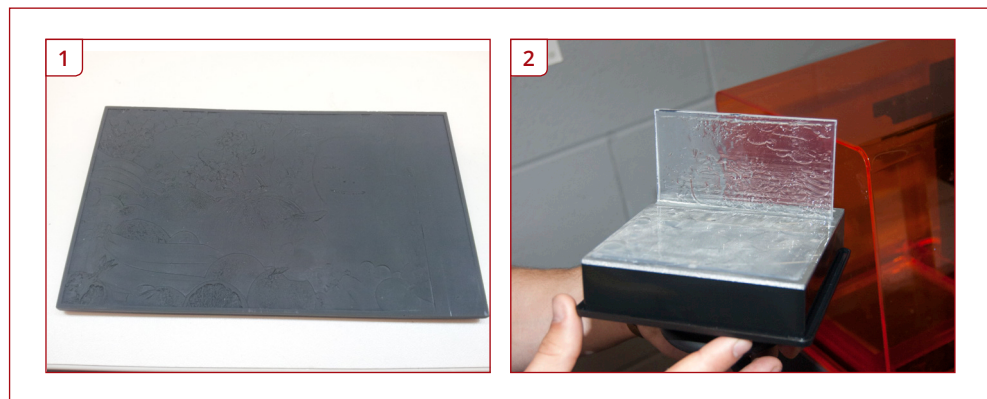

Figure 6.54 DLP printing plates. Both printed continuously on the Z axis with a relief height of 0.5mm

6.7.2 Advances in 3D printing

Access to digital light processing 3D printers became available in the last 10 months of the study while the thesis was being written. These DLP printers differ from the Polyjet printers that were used to print the first initial printing plates. The initial plates had a 16 μ m layer deposition whereas the DPL printers allowed the print to move continuously on the Z axis removing the stepping often associated with 3D prints. The DPL printing enabled a full 256 greyscale image to be printed at a depth of 0.5mm compared to the Polyjet which achieved this at a thickness of 4.096mm. Both the DLP and the Polyjet printers had similar print times and a 6in x 3in printing plate could be produced in 2 hours. This was considerably more expedient than the 16 hours needed to produce a CNC milled printing plate.

6.8 Colour registration for silicone printing plates

Initial tests for registration systems investigated tried and tested methods. A register pin system standard for print and photography was assessed (British Standards, 2006) ^[8] however it was best suited for substrates larger than 300mm (12 inches in lengths and it was not possible to use for the small sizes in this study. Standard office paper is often stored using a similar system when stored in folders or files (British Standards, 1972)^[9] and when bound (British Standards, 1974) ^[10]. The system that was then assessed used the standard hole punch for making filing holes (International Standards

8 BRITISH STANDARDS, 2006. BS ISO 11084-2:2006 Graphic technology – Register systems for photographic materials, foils and paper – Part 2 Register pin systems for plate making. BSI.

9 BRITISH STANDARDS, 1972. BS 1467:1972 Specification for Folders and files.

10 BRITISH STANDARDS, 1974. BS 5097-1:1974 Specification for Loose leaf binders – Part 1: Ring binders with metal mechanisms.

Organisation,1974)^[11]. The tolerance within the dimensions of the filing hole punch is quite large and would allow prints to easily mis-register. For the particular punch used the specification was available on the manufacturers website and the dimensions were plotted into the printing plate design so that a positive 'pin' would protrude allowing the substrate that had the holes punched to slot over and be in register. This can be seen in Figure 6.55 . This method was tested and failed on two counts. The gelatine ink holds a lot of water when it cools to the setting point. This causes thin substrates to warp and cockle under the weight of the gelatine making registration difficult. If the prints are left to dry in between colours the paper substrate will warp as the gelatine contracts making registration impossible (Figure 6.56). Thicker board substrates were used however the time taken to register the print after ink was poured on the printing plate proved to be too long and it would set before pressure could be applied, spoiling the prints.

This setback was included in the printing plate design and marks were included so that pins could be inserted at the same position on each plate allowing for a basic fence registration system. This stopped the print at the correct position on each plate. Further designs had the fence system included in the design of the plates. The plate could be prepared quickly and loaded with ink before it set allowing for printing.

The registration pins are only tall enough to catch the print on. They are smaller than the thickness of the mounting board that is used as a printing plate. It is possible to use longer sewing pins until familiar with the printing process. As long as they are on the outer edge of the tympan that is placed on top of the paper before pressure is applied.

6.9 Substrates for colour printing

Initial tests included photographic resin coated paper, shellaced paper, varnished paper and Yuppo paper. Flexible substrates were very difficult to work and register as mentioned in 6.8. Daler Rowney mount board was used. It was given six light coats of Windsor and Newton non-yellow matt spray acrylic varnish. When dry it was keyed with a 1:10 gelatine and water solution applied with a foam applicator brush. When dried for a second time it was given a final light spray of matt varnish and left to dry a minimum of 24 hours before use.

Chrome Alum was also tested after the gelatine layer, while it tanned the gelatine key layer it stained the substrate and it was decided not to continue with this method.

¹¹ INTERNATIONAL STANDARDS ORGANISATION, 1974. ISO 838:1974 Paper - Holes for general filing purposes - Specifications. International Standards Organisation.

The board worked extremely well. It did not warp and could retain its structure with multiple coats of gelatine ink applied. It registered very easily against the fence registration system.

6.10 Colour printing method.

The actual printing is performed in exactly the same manner as the traditional Woodburytype method. The plate is prepared with a release agent and warm gelatine ink is applied. The paper is applied with the keyed prepared surface against the ink and gentle pressure is applied to expel excess ink and left to cool. When cool the pressure is lifted from the print and it is removed from the printing plate.

A thin olive oil or vegetable oil was used as the release agent. It is very sparingly applied so that the surface is dampened and then wiped off with a slightly oily, lint free rag. Excess oil will not prevent the print adhering to the substrate however it will be on top of the relieved image where the next colour separation has to be registered. This oil will migrate through the print layer on top and will actually cause the second layer to mis-register as it dries. Less oil is best practice, typically one finger tip of oil lightly rubbed in is enough to spread on the surface and then wipe off again with the rag. As printing continues the plate becomes seasoned and less oil is needed each time.

There were two key observations when printing using rigid printing plates and flexible silicone printing plates with a rigid substrate. When the plates and substrate are pressed together a vacuum can form which, when the two are separated, the suction formed will tear the gelatine print layer. This can be avoided by using a flexible silicone printing plate and inverting it once the ink has set. By flipping the plate and print together the flexible printing plate can then be peeled back away from the print preventing any tears from suction.

Two printing methods were tested and will be described below. The two methods are wet on wet printing and wet on dry printing.

6.10.1 Wet on wet printing

Wet on wet printing involves using deformed separation plates generated in the same manner as the silicone printing. This method enables a warm fluid deposition of ink to be printed on top of the previous cooled relief layer. It was established from chapters 3 and 4 that the traditional Woodburytype model would have difficulty in plates registering due to the gelatine matrix separations drying at different rates, thicknesses and distorting in the process. Each separation would also need different ink concentrations and as printing continued the plate would wear. Additional plates made from the relief would over time crush the details of the matrix altering the

concentration of ink needed. Lastly the warm gelatine ink would re-melt the previous printed layers preventing registration and printing.

The wet on wet method being described here has avoided these issues by implementing the following adaptations to the traditional Woodburytype method. Firstly the depth and size of each printing plate is digitally controlled preventing unwanted distortion and allowing the concentration of ink to be prepared in advance. Lastly, the plates and prints can be refrigerated in between the printing of each colour preventing the liquid ink from re-melting the set ink – this is due to the plates being portable, lightweight, and small in size allowing it to fit in a domestic refrigerator.

In between the printing of each layer the printing plate and print can be chilled in a refrigerator. The printing plate ideally cannot be chilled to the extent that the warm ink sets on contact, this temperature will have to be determined in relation to the setting point of the printing ink used. The ink used in these tests had a setting point of 22-24°C. The printing plate was cooled to a temperature between 18-20°C and the printed separations were chilled to between 4-6°C between each deposition. The temperatures were read with a laser thermometer to avoid touching or damaging the set ink. Wet on wet plates are separation specific as they contain the information from the previous layer to allow for correct registration and ink deposition. The final wet on wet printed image is presented as Figure 6.57.

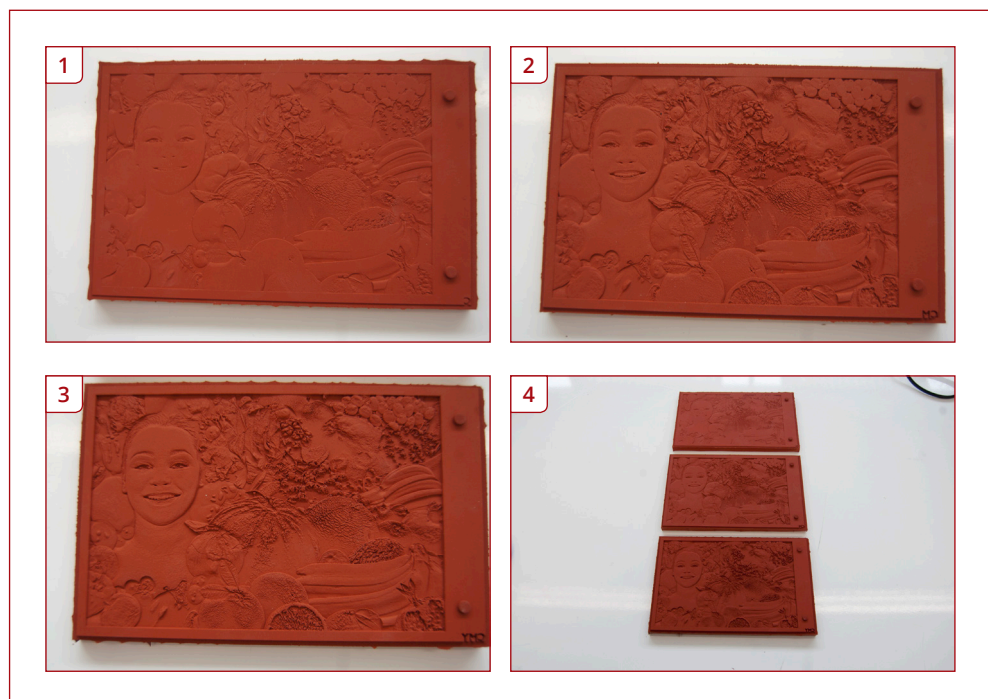

Figure 6.55 Silicone printing plates for wet on wet three-colour printing. 1) Cyan plate 2) Magenta 3) Yellow 4) The complete set of plates.



Figure 6.56 1) Printed results using the pin registration system. Notice the right hand side of the print where the separation layers have moved and the substrate surface is badly warped due to moisture. 2) Fence registration system used with rigid mount board substrate. Notice the tears in separation layers at the top of the image due to suction caused in removing the print. 3) Successful registration of the print and no tearing due to the inversion of the printing plate before removing from the print. Notice the right handside of the plate where the temperature was not correct and the cyan layer set too early. 4) The same image presented in 3, however it is now fully dried. Notice the vast reduction in print height and the sharp edge of the print boundary before the excess overspill in yellow.



Figure 6.57 A dried wet on wet print that shows secondary and tertiary colour mixing. The print remained in registration during drying as the use of oil as a release agent was kept to a minimum.

6.10.2 Wet on dry printing

The wet on dry printing method uses individual separation printing plates that are not deformed to contain the relief of the previous plate. Each plate has the same maximum and minimum relief depth. The wet on dry plates are not order specific. Each ink deposition is allowed to dry fully so that the relief shrinks before the next separation is printed. When each separation is fully dry a thin film of the release agent oil will have settled on the surface of the print. This can be wiped off with a clean dry lint free cloth before the next layer is printed.

6.10.3 Finishing processes

Once the final separations have been printed with either method ensure that no release agent is on the surface of the print. Once clean and grease free the print can be treated by applying a chrome alum solution with a foam brush applicator or by applying thin coats of spray varnish in a similar manner to preparing the substrate.



Figure 6.59 A wet on dry layer print with the last layer in relief before drying. The colours are more vibrant while wet and dull down as they dry. This image has been photographed while wet and the sheen can be noticed on the relief ink.



Figure 6.60 The final wet on dry layer print once dried. The print relief has shrunken and the image has sharpened as it dried. This image has been scanned and has not been colour corrected.



Figure 6.61 Original source image.



Figure 6.62 Image with no colour correction photo taken at the Centre for Fine Print Research, UWE Bristol, 2014.

6.11 Microscope image captures and print comparison

In this section microscope captures of the three colour wet on dry print are presented. They verify that secondary and tertiary colour mixing has occurred in this new printing model. They demonstrate that photo-realistic imagery can be generated and printed in colour through manipulating the surface topography of each ink deposition. They prove that no half-tone pattern or reticulation pattern exists in this new print method.

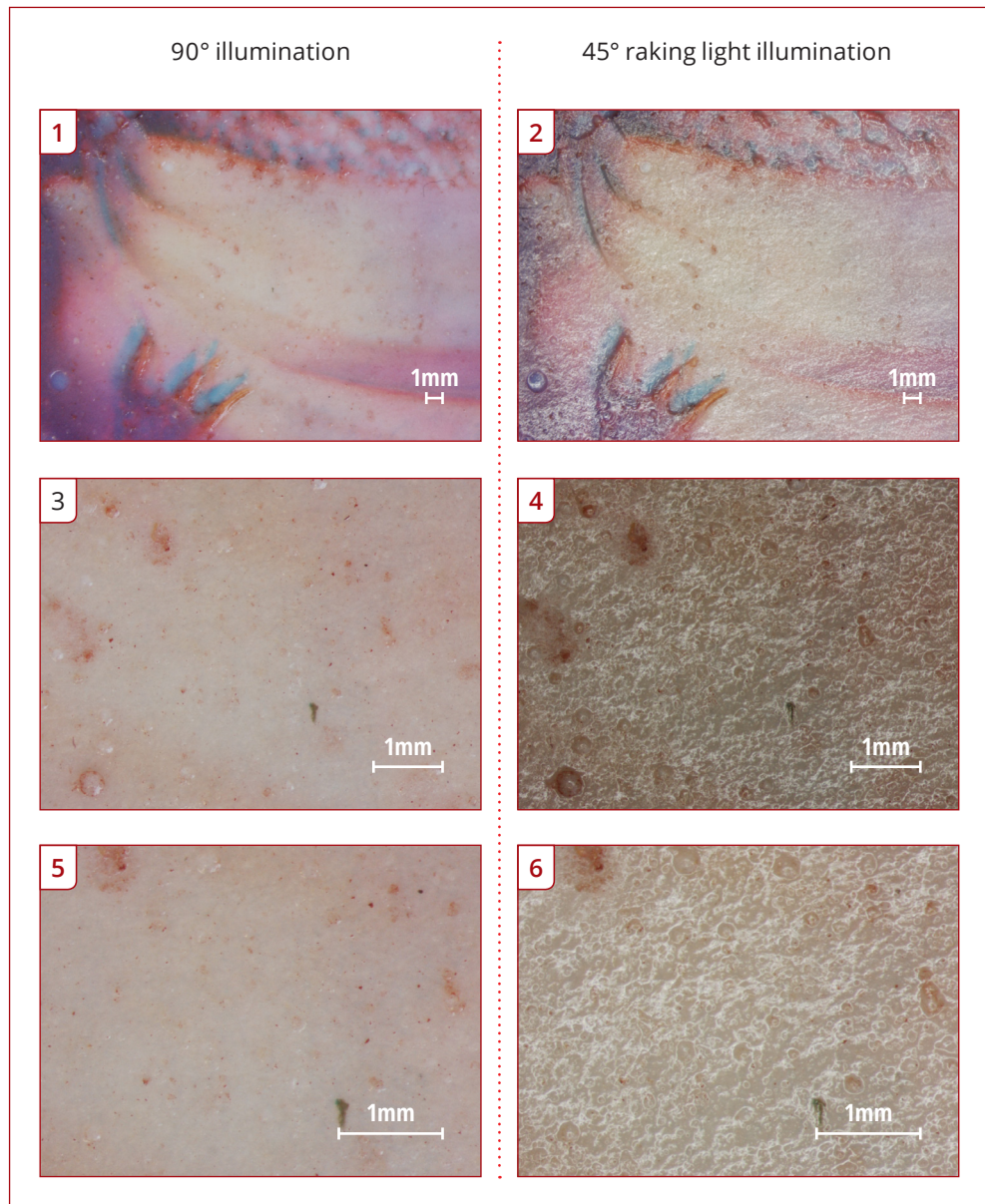

Figure 6.63 Banana. Each magnification is paired with the same scene illuminated and illuminated with a raking light. The image has not been colour corrected or enhanced.

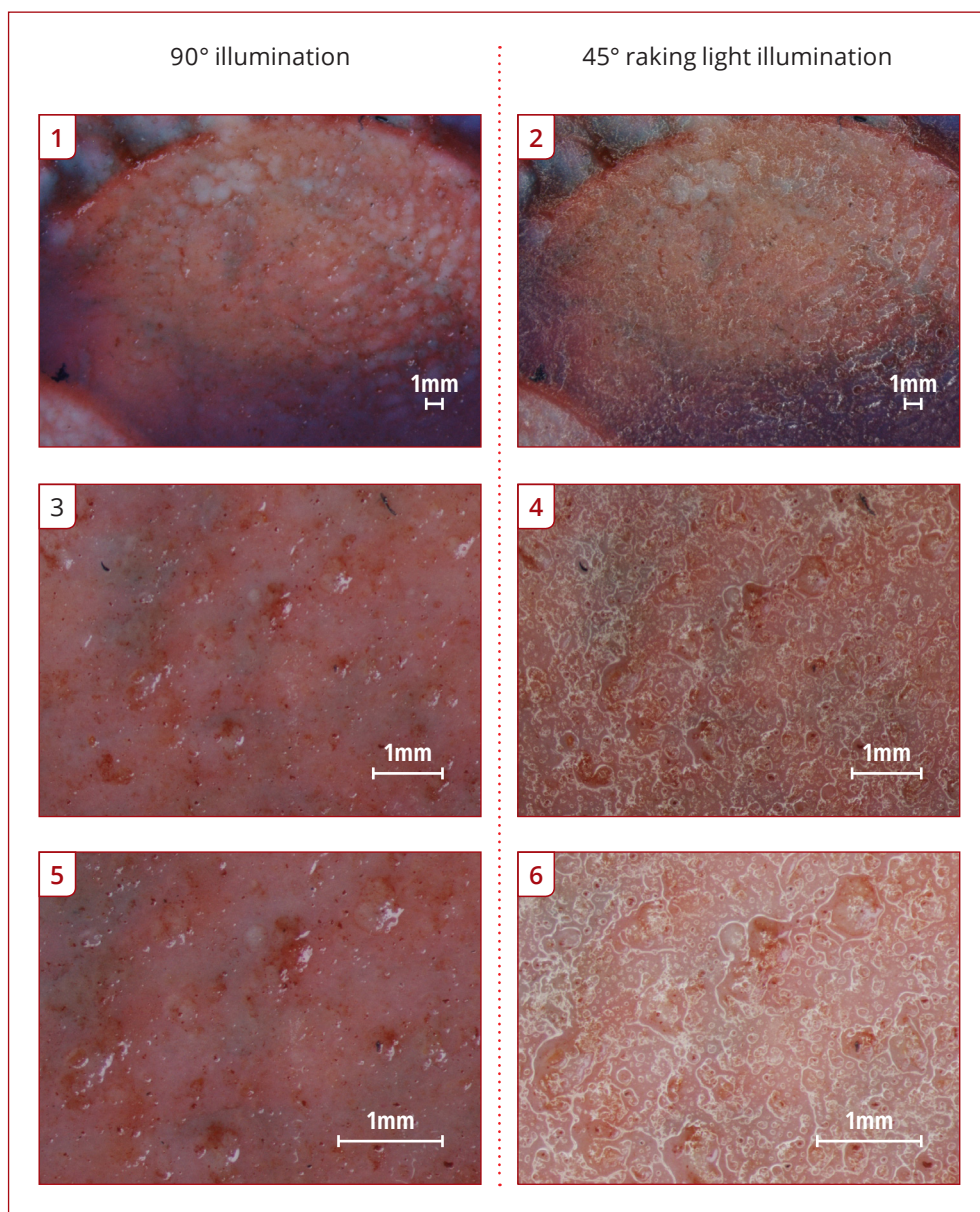

Figure 6.64 Cantaloupe. Each magnification is paired with the same scene illuminated and illuminated with a raking light. The image has not been colour corrected or enhanced.

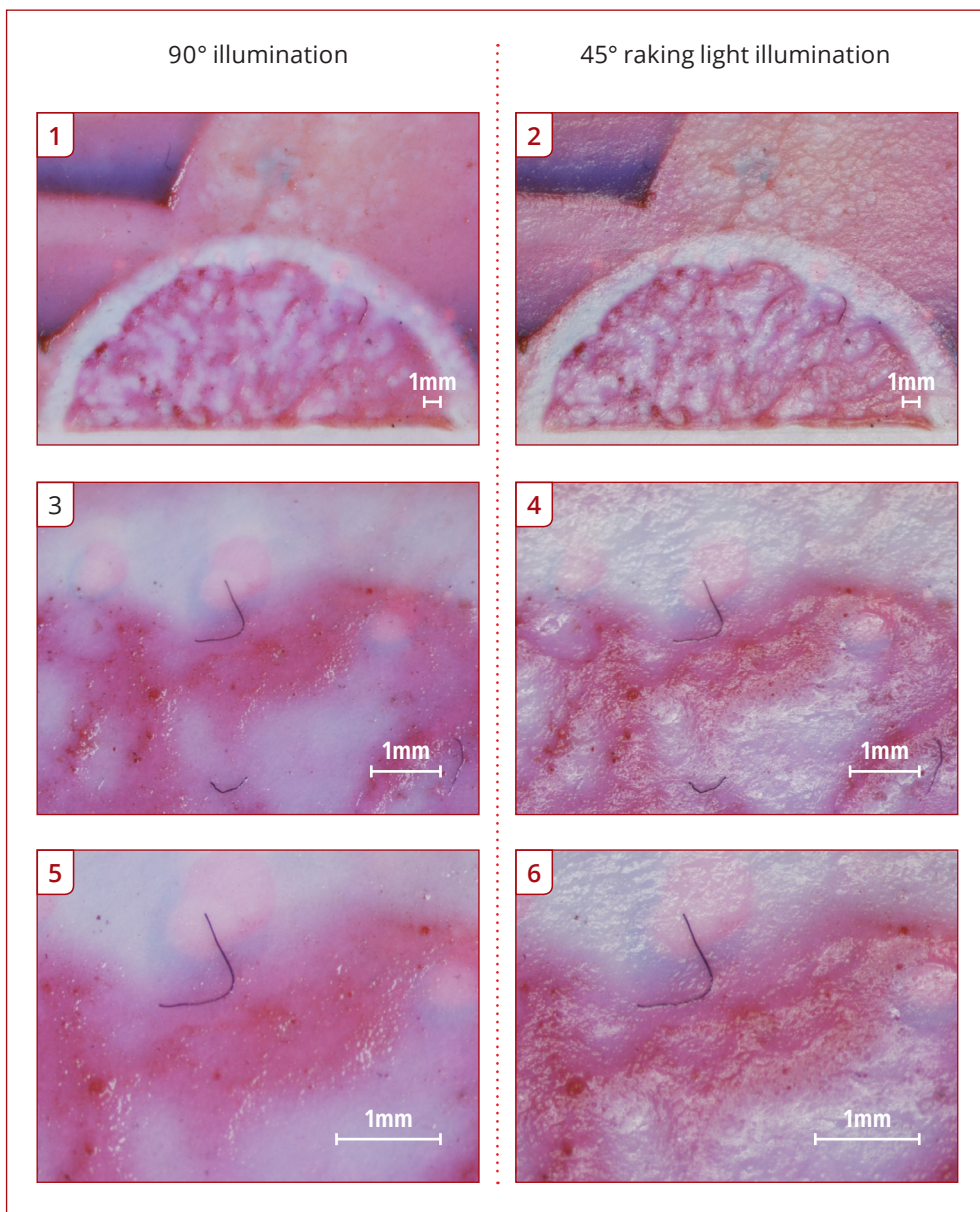

Figure 6.65 Orange slice. Each magnification is paired with the same scene illuminated and illuminated with a raking light. The image has not been colour corrected or enhanced.

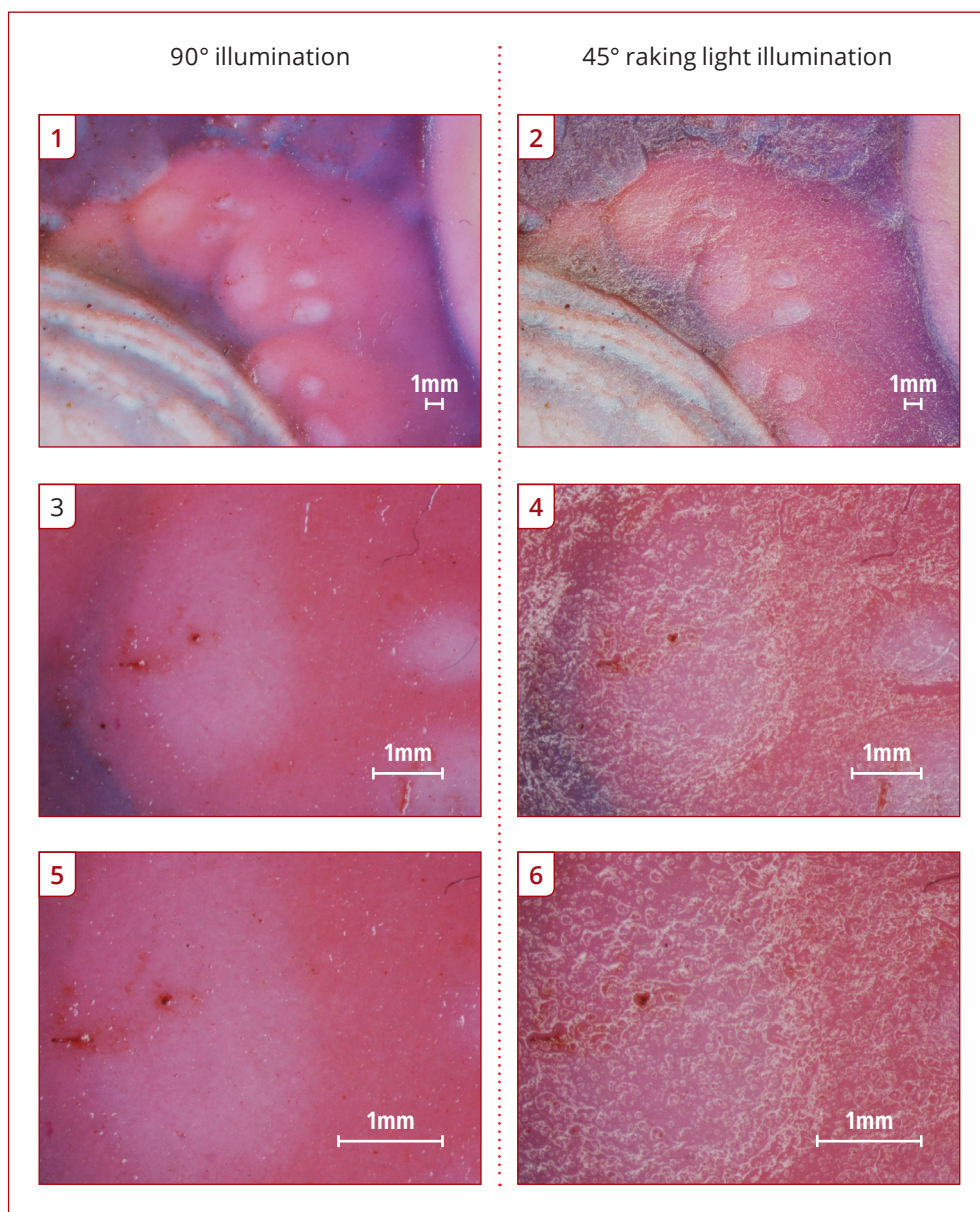

Figure 6.66 Red pepper. Each magnification is paired with the same scene illuminated and illuminated with a raking light. The image has not been colour corrected or enhanced.

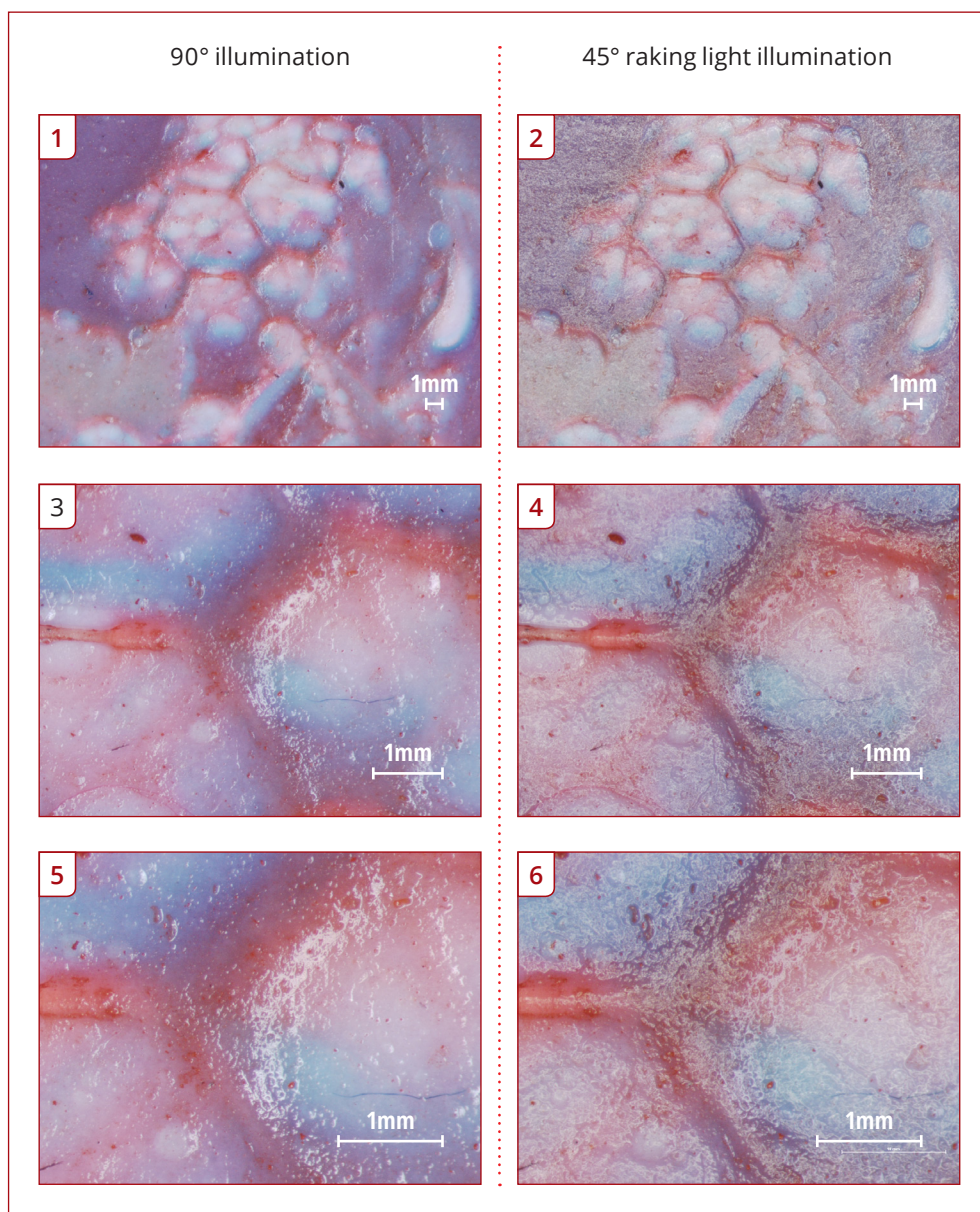

Figure 6.67 Pineapple. Each magnification is paired with the same scene illuminated and illuminated with a raking light. The image has not been colour corrected or enhanced.

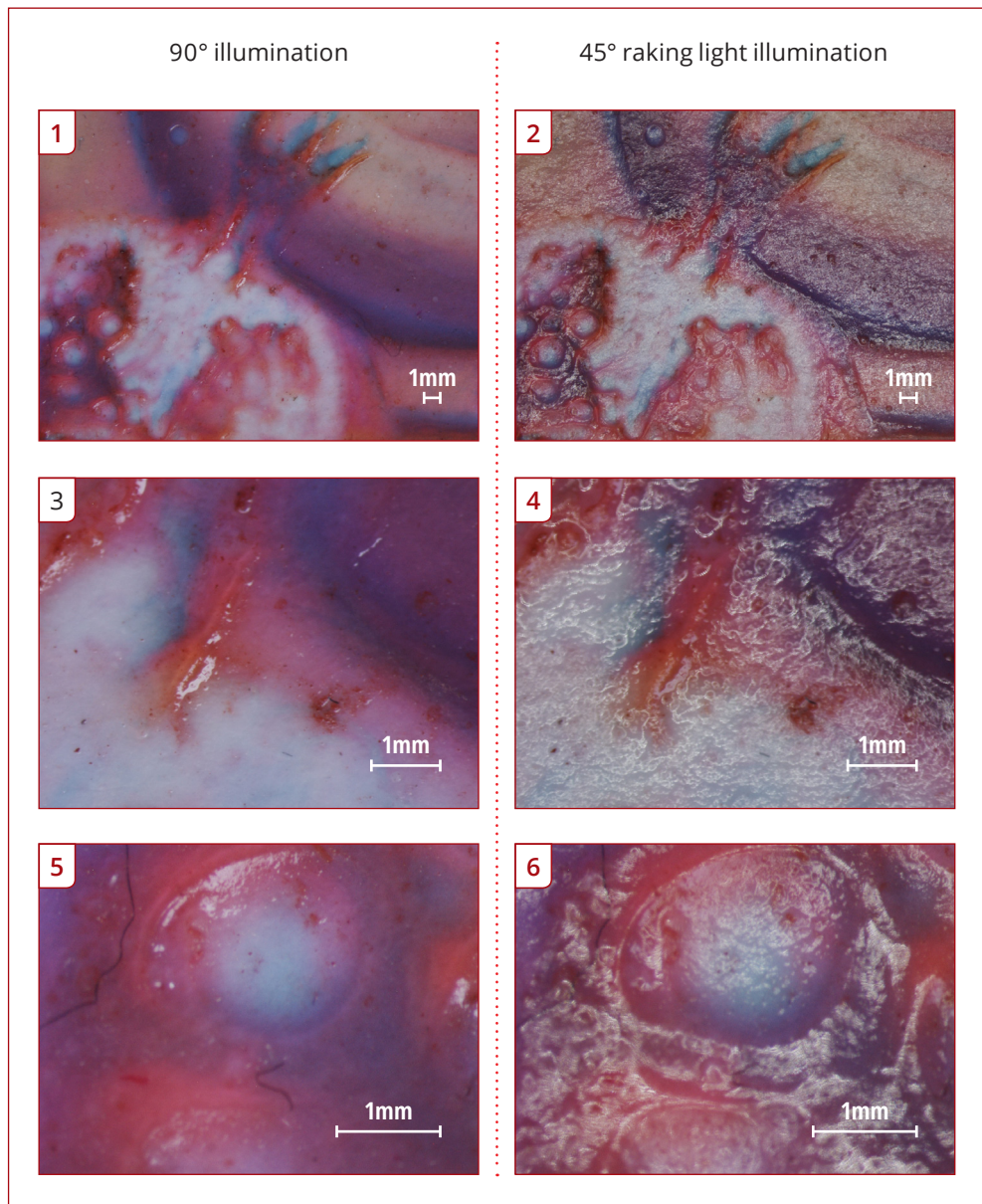

Figure 6.68 Pomegranate. Each magnification is paired with the same scene illuminated and illuminated with a raking light. The image has not been colour corrected or enhanced.

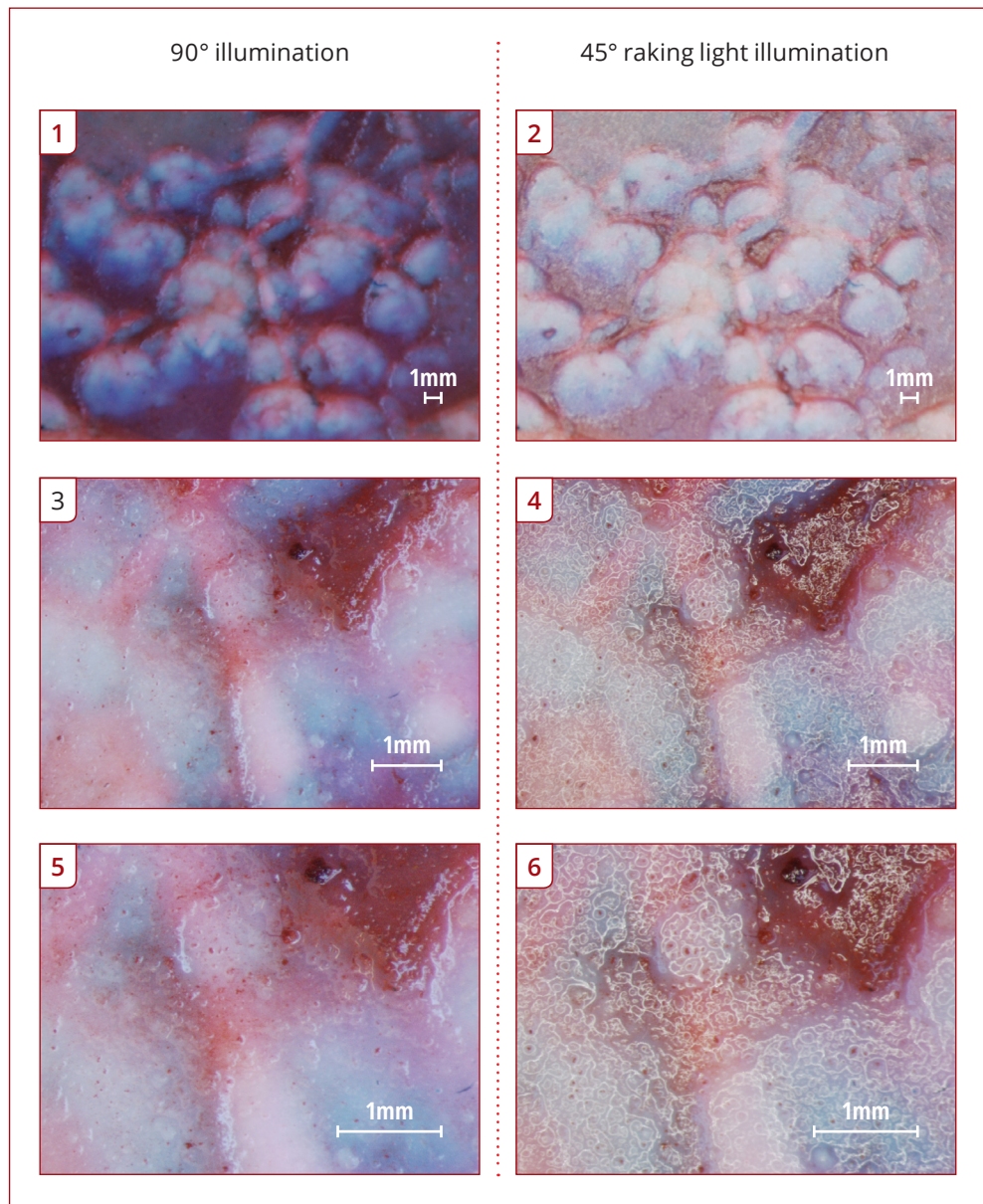

Figure 6.69 Red grapes. Each magnification is paired with the same scene illuminated and illuminated with a raking light. The image has not been colour corrected or enhanced.

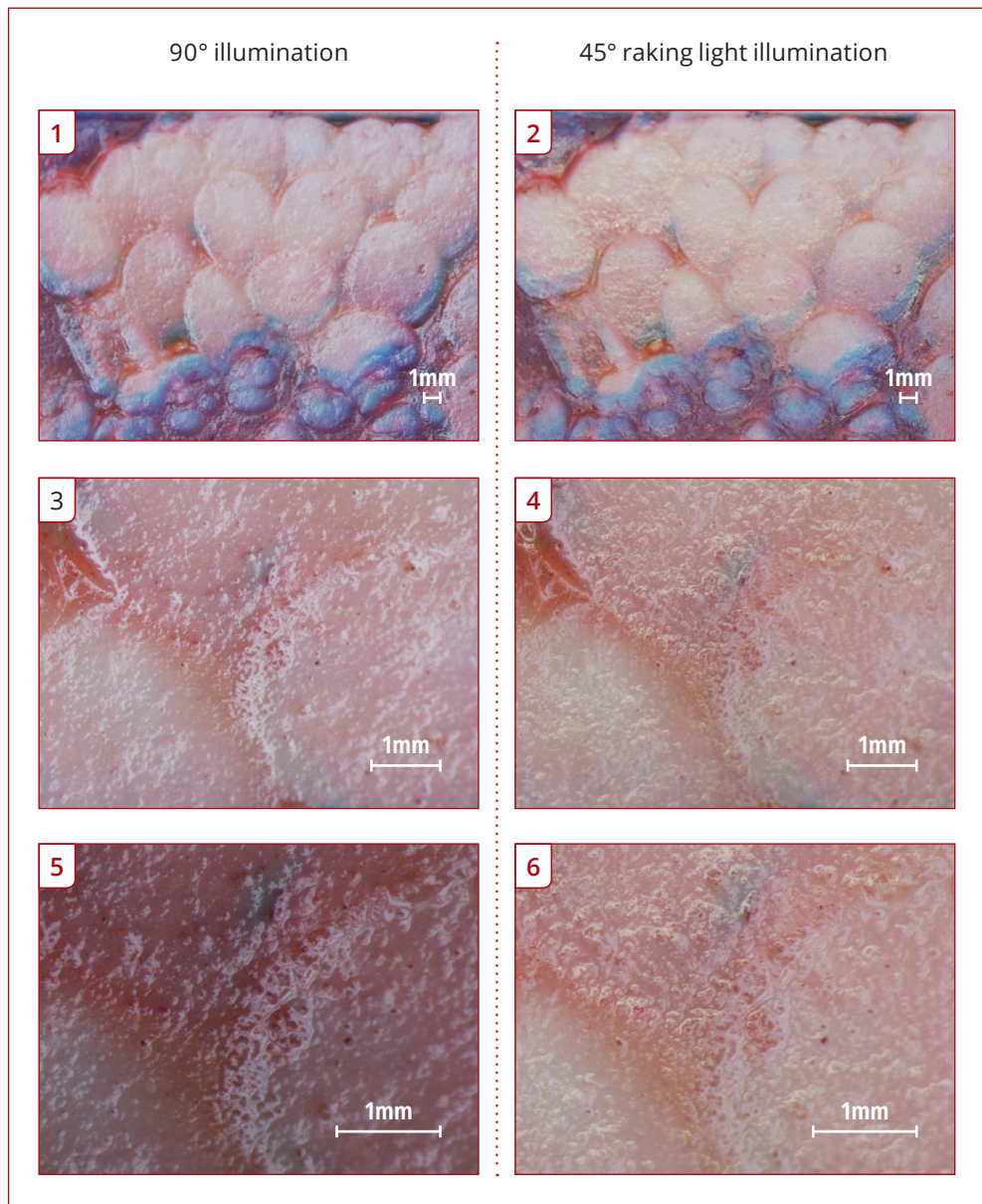

Figure 6.70 White grapes. Each magnification is paired with the same scene illuminated and illuminated with a raking light. The image has not been colour corrected or enhanced.

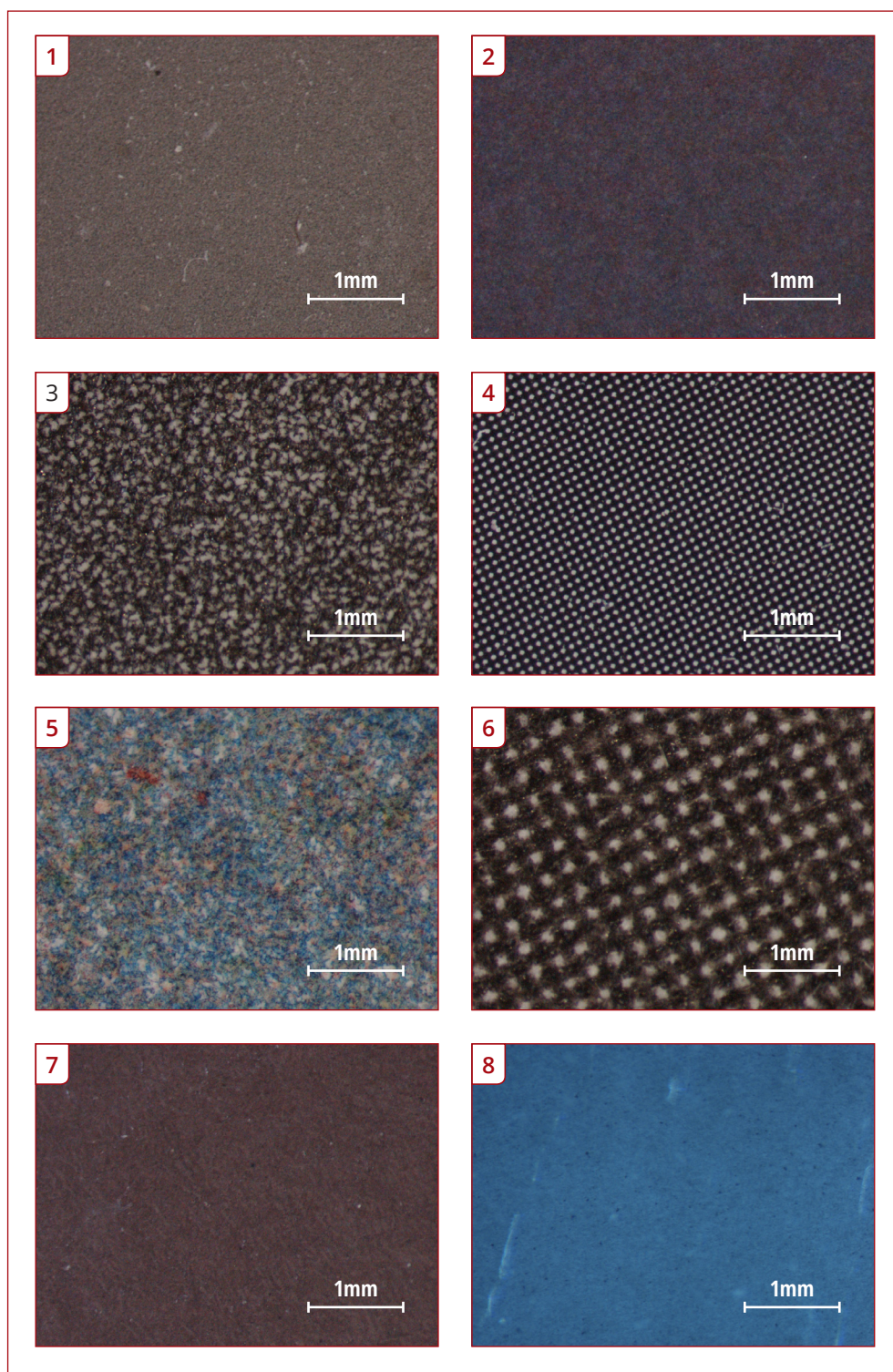

Figure 6.80 Various blacks and greys:
1) 3 Colour Carbon Print 2) C-Type Print 3) Collotype Print 4) Cromalin Print
5) Photogravure Print 6) Screen Print 7) Woodburytype 8) Silicone Print
Prints 1-6 captured from Digital Prints (Lowe, 1997) at CFPR

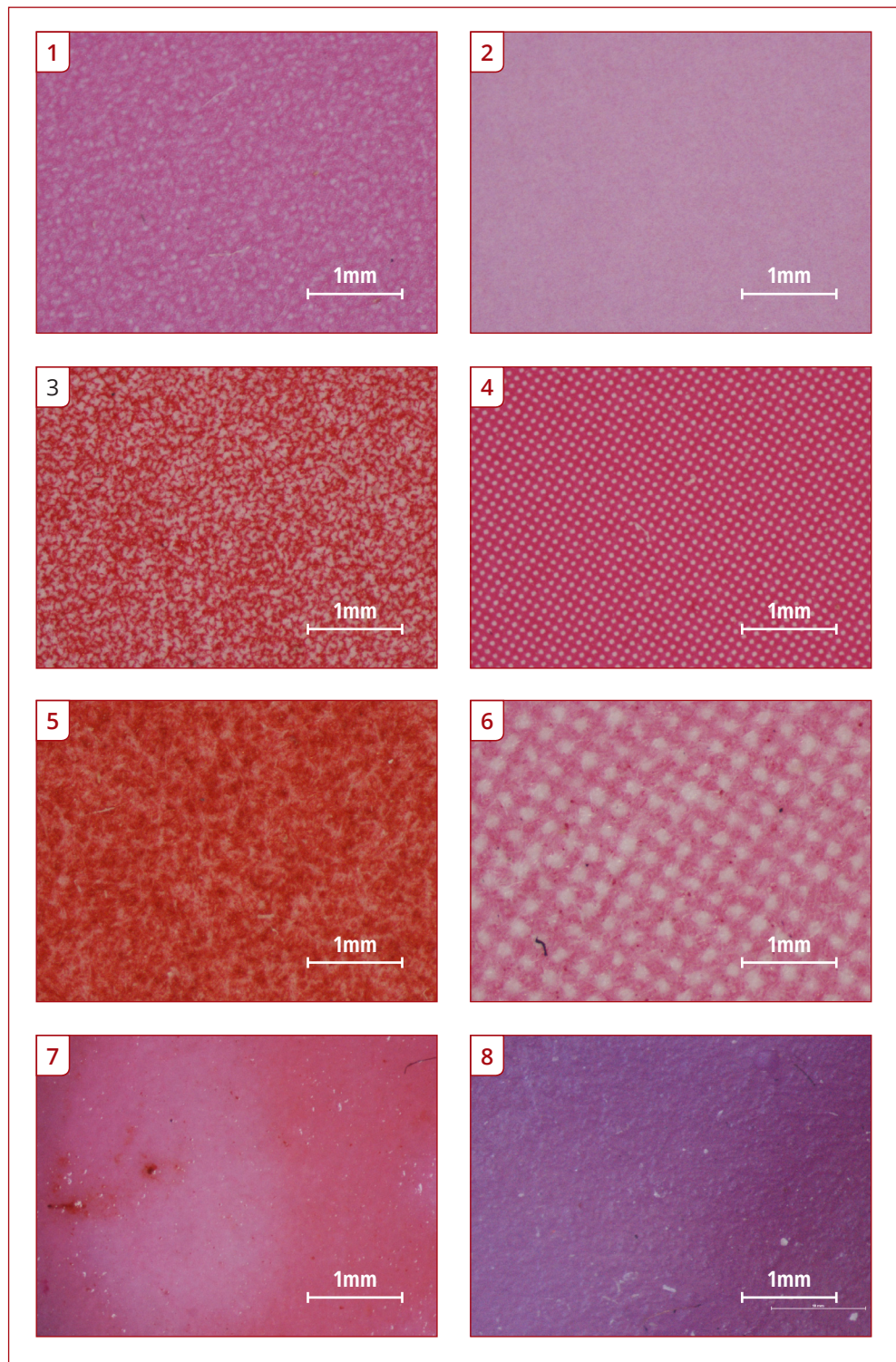

Figure 6.81 Various magentas and reds:
1) 3 Colour Carbon Print 2) C-Type Print 3) Collotype Print 4) Cromalin Print
5) Photogravure Print 6) Screen Print 7) 3 Colour Woodburytype 8) Silicone Print
Prints 1-6 captured from Digital Prints (Lowe, 1997) at CFPR

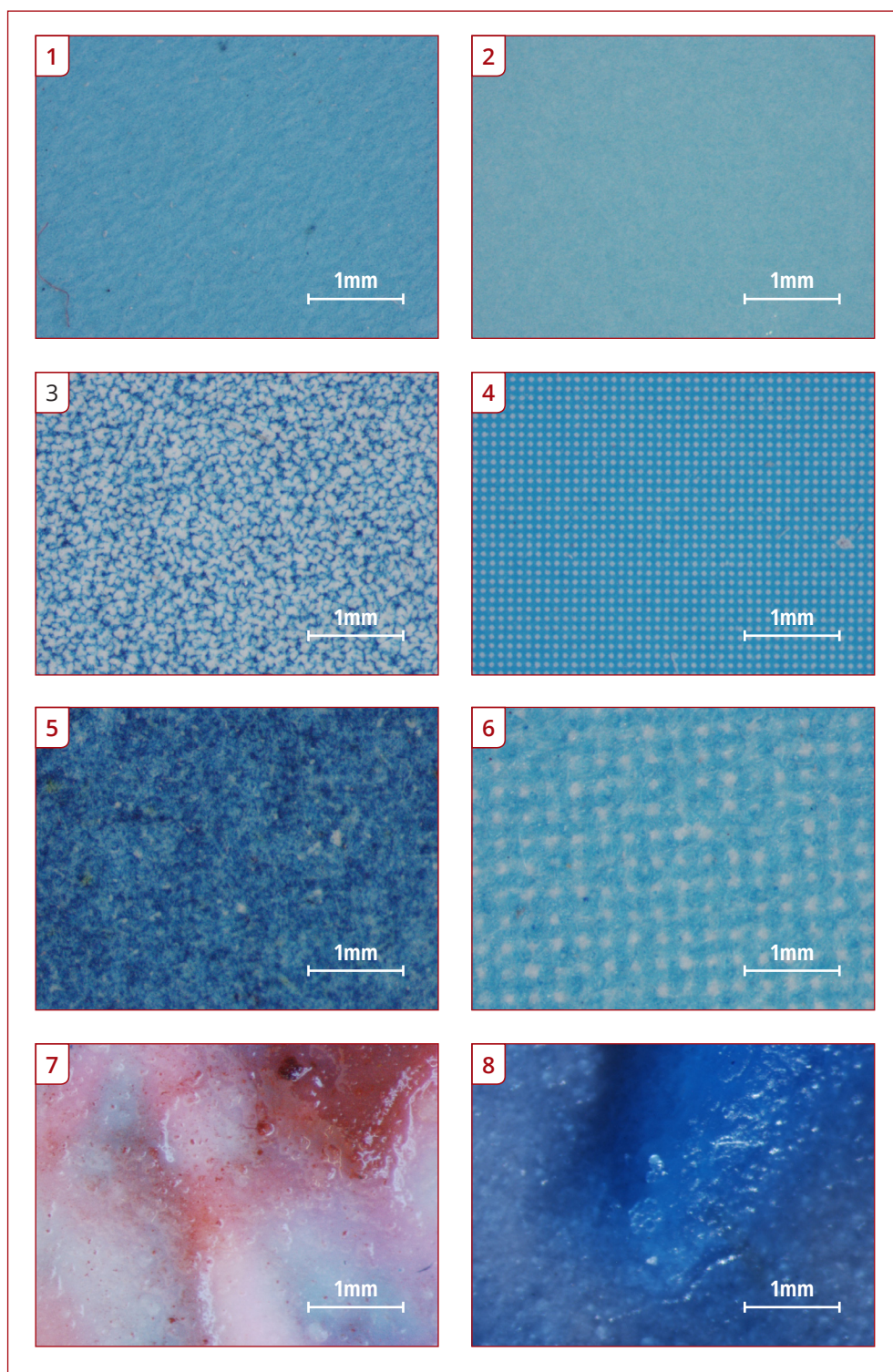

Figure 6.82 Various cyans and blues:
 1) 3 Colour Carbon Print 2) C-Type Print 3) Collotype Print 4) Cromalin Print
 5) Photogravure Print 6) Screen Print 7) 3 Colour Woodburytype 8) Silicone Print
 Prints 1-6 captured from Digital Prints (Lowe, 1997) at CFPR

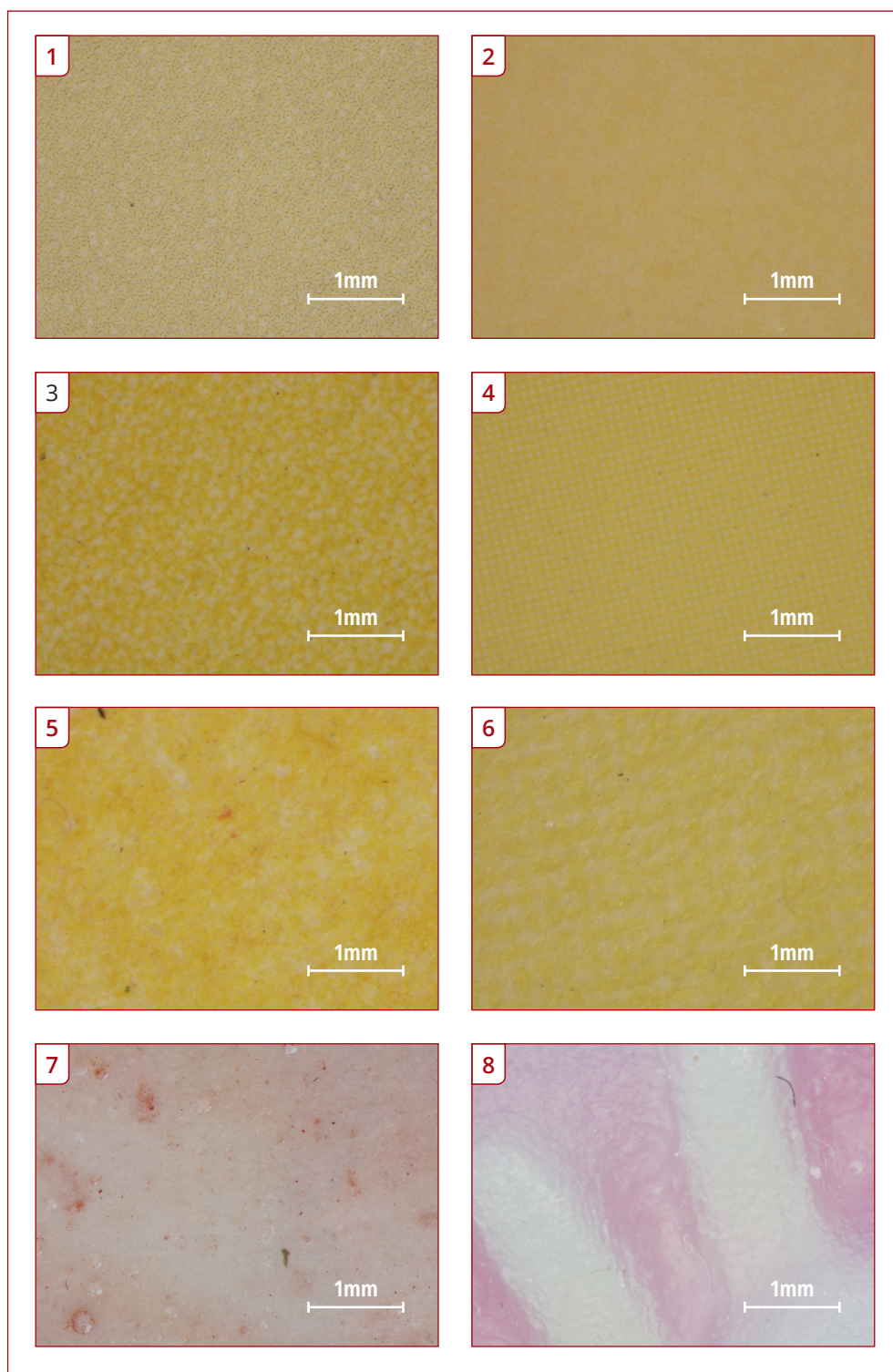

Figure 6.83 Various yellows and creams:

- 1) 3 Colour Carbon Print 2) C-Type Print 3) Collotype Print 4) Cromalin Print
 - 5) Photogravure Print 6) Screen Print 7) 3 Colour Woodburytype 8) Silicone Print
- Prints 1-6 captured from Digital Prints (Lowe, 1997) at CFPR

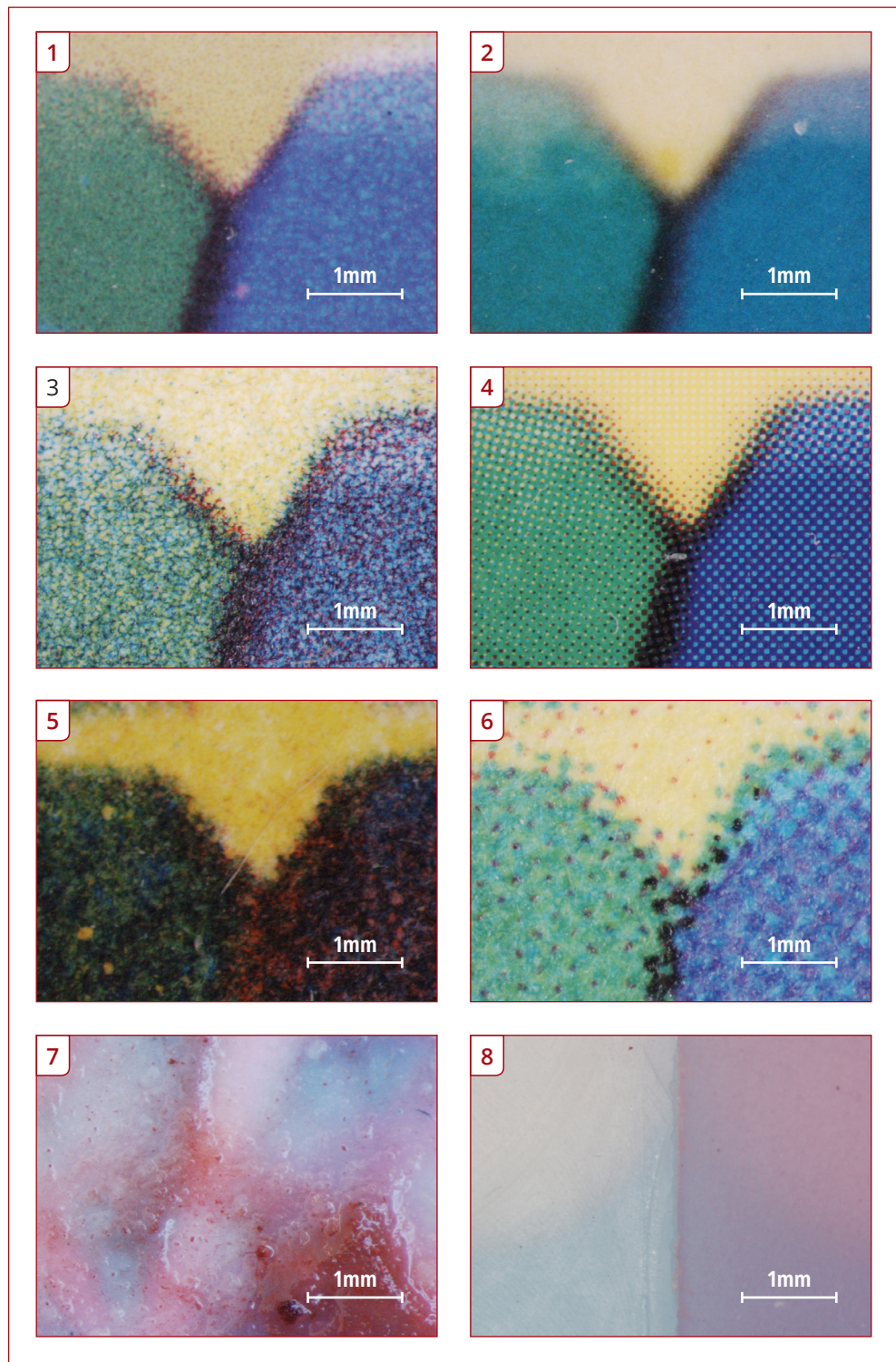

Figure 6.84 Various colour mixing:

- 1) 3 Colour Carbon Print 2) C-Type Print 3) Collotype Print 4) Cromalin Print
 - 5) Photogravure Print 6) Screen Print 7) 3 Colour Woodburytype 8) Silicone Print
- Prints 1-6 captured from Digital Prints (Lowe, 1997) at CFPR



Figure 6.84 Comparison of three continuous tone processes using the same source image.
1-2) Carbon Print. 3-4) Digital Woodburytype, 5-6) Digital 3 Colour Woodburytype

6.12 Additional observations

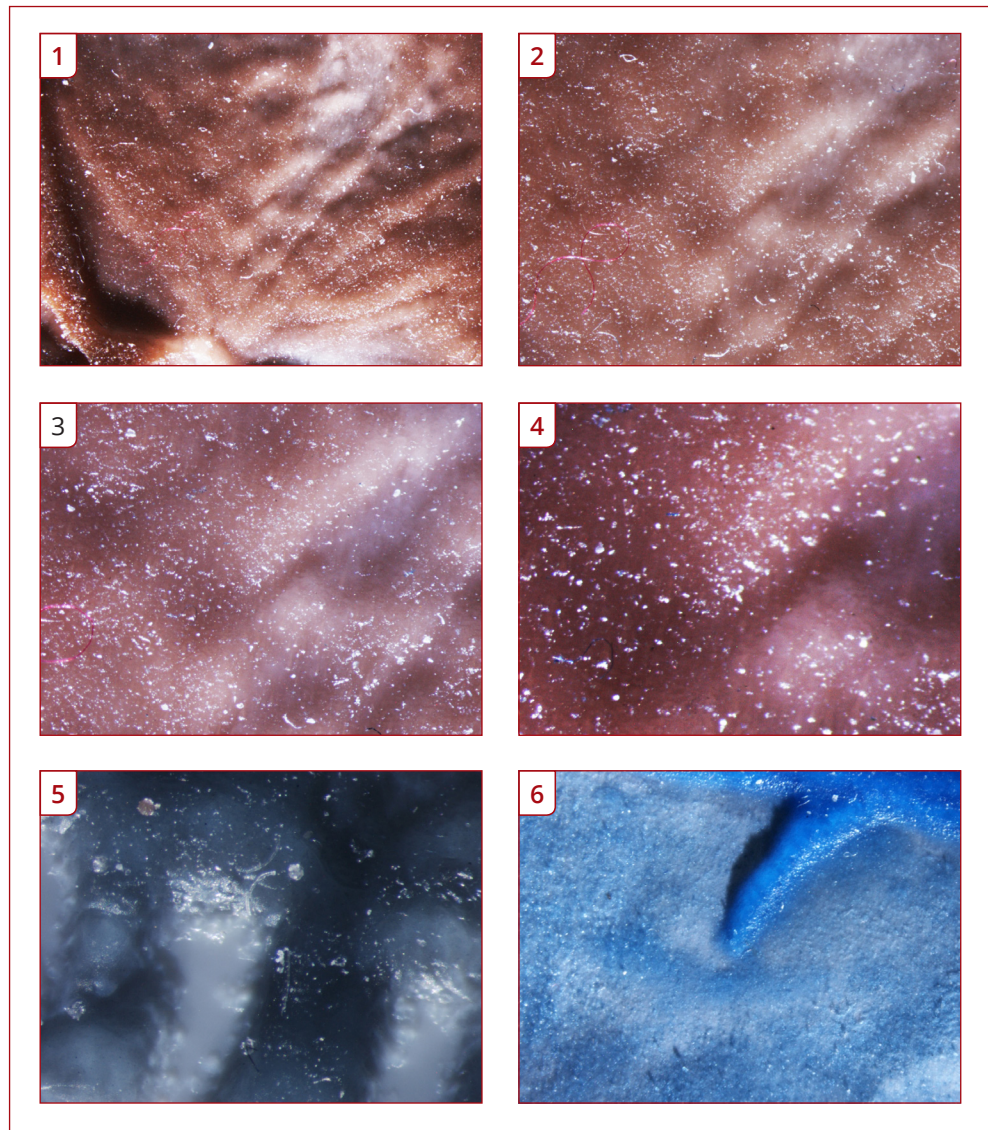

Figure 6.86 Raking light capture of silicone prints highlighting the relief surface that gives an artistic impasto effect on the print

Being able to print with a surface relief provides possibilities for printers to be able to print with a more artistic application of colour. Colour can be deposited in a relief separation that is controlled and measured allowing for faithful mixing of secondary and tertiary colours. In this study a silicone ink with a relatively short pot life was used. Other plastics and polymers could be used in future applications that are water clear and allow for larger plates to be used enabling injection or vacuum deposition of each separation.

3D printing technology has changed significantly since this doctoral research began. The initial 3D printer used in the project the Stratasys Eden printer has now been developed into a colour printer capable of printing seven colours in the same print build and at different states of rigidity and flex.

In the early stages of this research empirical tests were developed in that lithophanes were printed in each colour separation. A clear material was used, and these prints were dyed with aniline dye in the same manner that 3D printed prototypes are stained. The objective is that if the lithophanes are stacked then they should show colour mixing. The tests failed as the dye did not penetrate the lithophanes but only sat on the surface preventing optical colour mixing. This can be seen in Appendix 6.

In the final three months of this investigation, the researcher was able to access the new 3D colour printing technology and printed three colour separations in their respective primary colours. The objective of this crude test was to see if the separations when overlaid on top of each other would provide tertiary colour mixing and show an image with photographic colours.

The resolution of the polyjet printer still deposited each layer at 16µm. This resulted in each separation being 4.09mm thick to achieve the required 256 greys for the 8 bit image. This can be seen in Figure 6.87.

When the prints are overlaid and back lit, they do show tertiary colour mixing in the predicted areas. The method developed for colour mixing in the three colour Woodburytype model can be transferred to modern technology and adapted. With further research it is believed that the deformation separations can be used to print interlocking colour separations in one build. This opens interesting avenues in being able to simultaneously print photographic renderings in colour with multiple material qualities such as variable opacities, translucencies, rigidities, and flexibility all within one single 3D printed artwork.

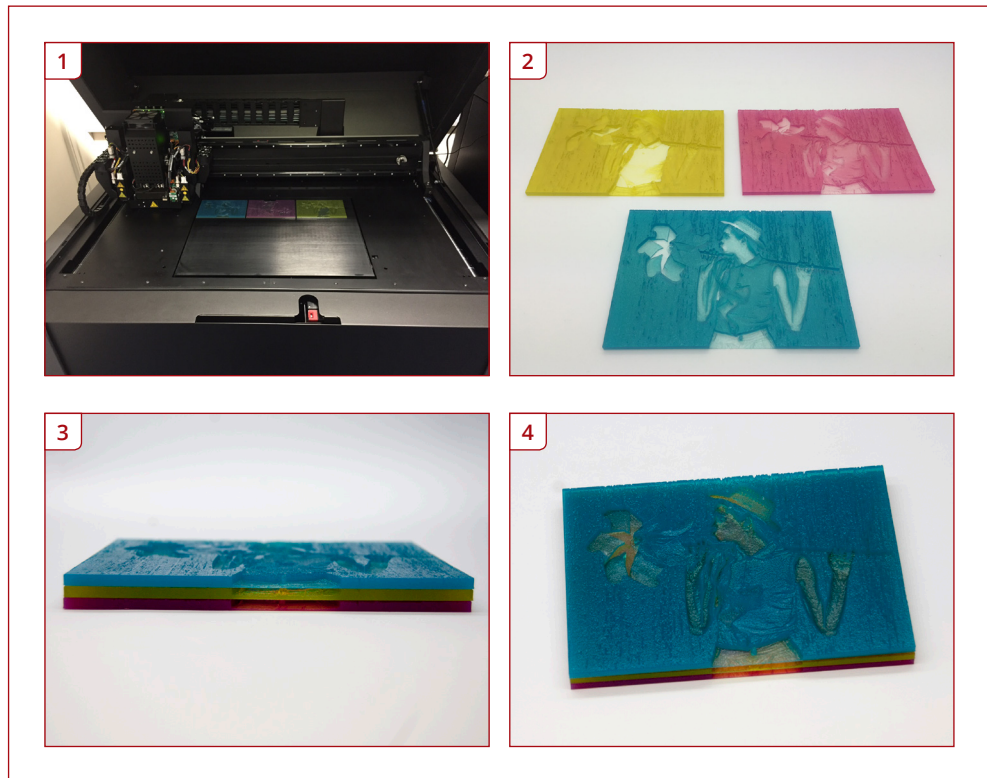

Figure 6.87 1) 3D printed colour separations that were printed simultaneously. 2) Each individual separation. 3) Side profile of the separations. 4) Overlaid separations and frontlit.



Figure 6.87 Backlit separations. (iStock/ FurmanAnna)



Figure 6.88 1) CMY separation order. 2) MYC separation order 3) YCM separation order
4) Original source image

6.13 In summary

This chapter satisfies the the questions initially asked in Chapter 1. Through the creative application of 21st century technology, qualities of 19th century continuous tone printing can be regained and developed further. The results of this study show that polychromatic prints can be achieved that allow for photo-realistic renderings to be printed without a half-tone structure and that, from semi-continuous tone printing plates, true continuous tone prints can be acieved in that they contain purely pigment suspended in the ink vehicle, which in this study was silicone and gelatine.

The next chapter provides a summary of each chapter and bring this research to a conclusion with areas for further research.

7 Conclusion and areas for further research

Synopsis: This draws conclusions from the research and presents areas for further research.

The aim of this thesis was to bridge the gap between digital and analogue by looking at the stages between ensuring a photograph's longevity and the mechanical reproducibility of the image. This thesis investigated the potential of a digitally produced continuous tone alternative to the half-tone process.

The thesis examined a specific topographical feature common across two 19th century processes, the Woodburytype and the Carbon process. They too achieved a large tonal range which directly proportional to the deposition thickness of a gelatine ink.

The research considered whether it is possible to create a colour separation printing process not based upon half-toning which provides an insight into alternative print methods not predicated on the half-tone but based on the same physical thickness of ink deposition to tonal range principal as used by the Woodburytype process.

The methodological approach taken in Chapter 2 identified that there was gaps in knowledge about the Woodburytype process. As modern imaging techniques are on the whole digital in nature most contemporary texts do not put emphasis on historical accuracy. As such the technical requirements and learning curve in fulfilling the process are beyond many of those that of those who are not already experts in wet-plate collodion photography and photomechanical gelatine print processes.

The literature review revealed that descriptions of the Woodburytype process changed overtime and that the most common way of performing the process may not have been the best but the method that was most widely reported. So that the process could be verified it was essential that the process was replicated in its entirety through the various methods of printing plate production.

It was always assumed by the researcher that the methods within the Woodburytype were not unique to the process. Through a historical analysis form processes that were in use from the mid 19th century to the early 20th century this assumption was confirmed and verified in Chapter 3. The Woodburytype is indeed a combination of multiple print processes. The Woodburytype itself utilises stages of production and manufacturing similar and in some cases the same as other processes. The

mechanically produced prints do however produce a unique quality of photographic rendering, that as yet have not seen or equalled by the research in any other digital or photomechanical process.

The empirical recreation of the process presented in Chapter 4 was the outcome of several months of failure and frustration. The process itself is arduous and complicated. However the best way in understanding and learning the process is to do it. Through practice the process does get easier and becomes very satisfying in completion. It must be stressed that before this body of research I had no experience in any of the gelatine or photomechanical printing processes. As such the most difficult aspect was that there was no standard 'how-to' guide and this process was extensively researched and cross referenced. The outcomes from Chapter 4 contribute to the knowledge of this historical process and do add to the existing knowledge base. As such the findings of this historical research will be included in the Centre for Fine Print's Woodburytype Database.

It was identified that access to a hydraulic press is still one of the most difficult challenges. Successful printing plates were produced through the use of a star press, a gravure press and by silicone casting the relief. Through the replication of the process it was confirmed that one of the factors that prevented colour printing was not necessarily printing gelatine on top of gelatine but producing a series of gelatine relief matrices that could register. This led the study naturally into chapter 5.

Chapter 5 evaluated digital imaging methods, manufacturing processes and testing procedures. Previous academic studies provided strong evidence that a Woodburytype printing model could be reproduced digitally, however they were unable to make the process polychromatic. In this chapter it was shown that manufacturing processes have developed since those earlier studies. The inclusion of 3D printing technology within this research was interesting in that over a four year period the technology advanced significantly. A printing plate with an 8-Bit greyscale relief refined from a 4.09mm polyjet plate to 0.5mm DLP plate. The most dramatic outcome with this is that the printing plates can be produced in less than 2 hours compared to 16 hours when CNC milled. This is a great improvement.

Resolutions have also improved due to technological advancement. The DLP printing plates were produced with a continuous build on the Z axis, and they do not contain the softening of detail found with the step-over of CNC milling. The digital and mechanical methods of producing print plates discussed in chapter 5 removes the registration problems with traditional Woodburytype plate manufacture. The introduction of production and testing standards allowed for the development of a repeatable colour printing process in Chapter 6.

Chapter 6 presents the core contribution to knowledge within this research. It answers the initial research question and has proven that it is possible to create a colour separation print process that is not based on half-tone screening. A method of producing colour separations was developed that is essentially a three dimensional model of the overlapping ink deposit thicknesses. It is demonstrated in this chapter that photo-realistic renderings are possible using this printing method, and moreover that the colour mixing is very predictable and faithful to the digital source image file.

Strong evidence has been presented that this method of colour printing is successful. I believe that this method of generating the colour separation and printing plates presents an area for development. In this study a straight translation of grey value to height depth was used. Each grey level has an equal step distribution in the relief. This can be further researched to determine if other grey-level translations would refine it such as a logarithmic tonal curve translation from light to dark.

The principals used to generate two and three colour prints behaved in a very predictable manner. This was then translated to produce four colour separation plates however due to time restraints prints were not “pulled”. I believe that a successful image can be created in four or more colours. Overprinting to intensify the tone, hue and deposition thicknesses are also areas that interest me in exploring through further research. Altering the thickness of the deposition present and opportunity for a more artistic approach to colour application. It may be possible to print “impasto” or other painterly techniques.

The novel approach of using alternative ink systems such as silicones and plastics instead of traditional gelatine systems associated with the Woodburytype were also successful. The main limitation of this however was that in order to achieve a strong shore hardness the clearest material was “water white” which when printed made the images resemble a faded colour photograph. This process of using plastics and polymers I believe has a large potential to be explored further. At present the silicone colour prints have some interesting properties in that they can be printed onto non-flat surfaces, stretch, twist and distort and then return to their original shape and size. The surface texture of the printed surface also changes drastically depending on the material that the printing plate is made from. Plates with a high sheen produce glossy prints whereas matt plates produce matt prints. It seems possible that multiple surface textures and finishes could be all contained within one print.

One of the most promising areas for further research I believe is the work produced from the 7 colour polyjet 3D printer system. The colour separation model used for wet

on wet printing and silicone printing I propose can be used to produce a solid colour separations that interlock to produce a layered three dimensional photorealistic colour image. Furthermore I propose that these separations could further more be re-assembled by alternating the primary colour at each 16 micron deposit so that the pigment deposition produces a more “solid” photographic cellular colour. As the technology advances this will be able to be refined. HDR imagery with 16 and 32-bit greyscale will also enable sub-pixel grey levels broadening the tonal value and enabling higher definition 3D digital models.

In summing up this research successfully answered the research question. This can be validated through inspection of the microscope cross-sections which confirm that the tonality produced in the printed image are proportional to the ink deposition thickness. There is no cellular reticulation or half-tone patterns in the print. The tones are simply pigments in suspension at various thicknesses. The colour saturation is controlled by the layering of the ink deposits through the colour separation and registration system, designed specifically to faithfully reproduce photo-realistic colour images.

Throughout this research I used the analogy that printing came to a crossroads. It could turn left and pursue continuous tone print making or it could turn right and pursue the development of half-tone images. At the turn of the 20th century continuous tone printmaking technology wasn't being developed at the same rate as half-tone technology. I believe that we have now reached a technological stage that will enable researchers to go back to that crossroad and use 21st century technology to re-address this century old gap in development. This research has shown that by looking at alternatives to half-tone image generation are possible and furthermore by using ink deposition thickness it can add an extra dimension to the surface structure of the printed artefact by producing low relief photo-realistic three-dimensional printed imagery.

A4 Appendix for Chapter 4

A4.1 Timeline of key events Walter B. Woodbury

- 1834** Born in Manchester June 26
- 1842** Death of his father
- 1848** Apprenticed to a local firm of Patent Agents in Manchester
- 1852** Left England for Australia
- 1854** Awarded a medal for a set of photographs of Melbourne exhibited at the Melbourne Exhibition
- 1856** Arrived at Djakarta in Java accompanied by James Page.
 - Established the Firm of Woodbury & Page
- 1859** His brother Henry James Woodbury arrived from England to join the firm.
 - Returned to England to arrange a regular supply of photographic materials.
 - Made arrangements with Negretti & Zambra for them to market the topographical views that he had taken in Java. Made acquaintance of Arthur Rowbottom
- 1860** Returned to Java and opened a new studio known as 'Atelier Woodbury' at Chiribon. Undertook leadership of a photographic expedition to the interior of Java.
- 1862** His brother, Albert Woodbury arrived from England to join the firm.
 - Married a local girl Marie Olmeyer.
 - He and his bride left for England.
- 1864** Granted patent for the Woodburytype Process 24th September.
 - Announcement of Swan's Photo-Mezzotint in Photographic News 14th October
- 1865** Birth of his son Walter E Woodbury
 - Photo-relief printing process announced in British Journal of Photography July 6th.
 - Swan receives patent for Photo-Mezzotint process 18th August.
 - Woodbury used lead plates for the first time
- 1866** The first Woodburytype print "Mountain Dew Girl; Kilarney" from a negative by Henry Peach Robinson to be published appeared in the issue of "The Photographic News" Jan 26th.
 - Woodbury Photo-Relievo Printing Company formed.
 - Goupil buys patent rights for France for Woodburytype. (Photoglyptie in France)

- Woodbury Photographic Company buys patent rights that covers Swan's Photo-Mezzotint process.
- 1867** First patent in the photofiligraine process
- 1870** Carbutt buys patent rights for America, moves to Philadelphia and starts new shop
- Franco-Prussian war destroys Goupil's shop
- 1871** Made the acquaintance of James Marcy (designer of the Sciptiocon lantern in philidelphic whilst on a visit to America. Sciopticon company formed).
- 1872** A lapse in getting the Woodbury relief paten renewed caused complications which resulted in the process not becoming publically available. The rights were retained by the Photo Relief Company under the patents held for Swan's Photo-Mezzotint process as the two processes were so similar.
- 1875** Treasure Spots of The World published
- Wrote The Stenograph Manual
- Introduced Ihe Stenochromatic Process
- 1877** Granted patent for his system of aerial photography from a tethered balloon, Woodbury Tourist Camera marketed.
- Arrangements made with R.Talbot of Berlin for the marketing of Talbot's pyrohydrogen lamp for projection lanterns.
- 1878** Street Life in London published
- 1879** Granted patent for the Woodbury Photometer
- 1881** Street Incidents published
- Granted Patent for the Stannotype Process
- 1882** In financial difficulties, sight failing and general health poor.
- 1883** Awarded the Progress medal of the Photographic Society for his invention of the Stannotype Process.
- 1884** Granted patent for his Hygrometer.
- Granted patent for a musical signaling system for railways
- 1885** Granted patent for the rendering of paper transparent thus making it suitable for use as a flexible support for negative emulsion in place of glass. Negotions taking place for a patent application in respect of a system of sound recording.

- Died in Margate during the night of September 4th / morning of September 5th aged 52 due to an overdose of Laudanum. The inquest found insufficient evidence to say if it was accidental or otherwise. Accounts in the Whitstable Times and Herne Bay Herald (Sat 12 September) hint that Woodbury was suffering from depression and drinking more than was good for him up to a bottle of brandy a day. He also was suffering from diabetes and was taking laudanum to relieve pain and to ease sleep and was noted to have said that laudanum has no effect on him. He was buried at Abney Park Cemetery, Stoke Newington on Saturday, September 12
- 1888** It was mentioned in Photographic Journal 30th November 1888 in a discussion of using electric lights for photographic exposures that Walter B. Woodbury before his death was experimenting using arc lights for this purpose. While looking directly at the arc light he nearly destroyed his eyesight.
- 1889** A Cabinet card print / quarter plate Woodburytype cost 2s
- 1896** You did not need rights to use the process at this time, however it was very difficult to get printing plates made.
- 1928** Eder sells the (believed to be) last Woodburytype press for scrap.
- 2000** Mats Broberg finds the last remaining Tangye Bros. Woodburytype hydraulic press in Wrought Artworks' workshop, Redfern, outside Sydney, Australia

A4.2 British Patents awarded to Walter B. Woodbury

- 2338 September 23 1864.
An Improved method of Producing or Obtaining by the aid of Photography Surfaces in 'Relievo' and 'Intaglio' upon Aluminous, Viterous, Metallic, or other Suitable Materials.
- 2338 September 23, 1864.
Woodbury's Amended Disclaimer and Memorandum of Alternation to the above Patent
- 105 January 12 1886.
An improved Method of and Apparatus for Finishing Impressions (in Coloured Gelatine or other Soluble Material) obtained from Metallic or Other Plates Produced by the Aid of Photography
- 1918 July 24, 1866.
An Imoroved Method and Apparatus for Printing from Metal Intaglios (Obtained by the Aid of Photography) in Gelatinous or Other Semi-Transparent Ink.
- 505 February 17, 1866.
Improvements in the Production of Ornamental Surfaces for Jewellery and Other Purposes.
- 1315 May 8 1866.
Improvements in Producing Designs upon Wood and Other Materials by the Aid of Photography
- 947 March 30 1867.
Improved Means of Producing Designs upon Paper
- 346 February 7 1870.
An improved Method of Producing Surfaces by the Aid of Photography
- 2171 August 4 1870.
An improved Method of Producing Surfaces by the Aid of Photography
- 1563 May 22 1872.
Improvements in Magic Lanterns
- 3654 December 4 1872.
Improvements in Photo-Mechanical Printing, and in Apparatus and Appliances Therefor
- 1954 May 30 1873.
Improvements in Photo-Mechanical Printing, and in Apparatus and Appliances Therefor
- 3867 October 6 1876.
Improvements in Magic Lanterns and Apparatus to be used with same.

- 1099 March 19 1877.
An Improvement light, Applicable for Magic Lanterns Theatres, and other Purposes, and Apparatus connected therewith
- 1647 April 27, 1877.
Improvements in Photographic Apparatus (Balloon camera, and folding camera.)
- 2912 July 22 1878.
Improvements in Means for Methods of Producing Designs upon Paper, Cloth, or other Fibrous or Soft Material
- 3760 September 19 1879.
Improvements in Means for and Methods of Producing Designs upon Metallic Surfaces.
- 2527 June 10 1881.
Improvements in Printing Surfaces
- 2981 February 8 1884.
Improvements in Methods of Producing Printing Blocks by means of Photography.
- 5164 March 19 1884.
An Improved device in Methods for Testing the Presence of Moisture in Linen and Other Articles.
- 10,911 August 2 1884.
Improvements in the Method of an Appliances for Railway and other Signalling.
- 9575 August 11 1885.
An Improved Method of Making Paper Transparent to render it Suitable as a Substitute for Glass for Photographic and other purposes.

A4.3 Bibliography of Articles relating to Woodburytype

1. Abney, W.D.W. (1896)
Affiliation of Photographic Societies. Six Lectures on "Photography with the Bichromate Salts" i)
Scientific and Historil Preliminary. The Photographic Journal. May 29 (36), pp.254-259.
2. Atkinson, A. (2005)
The Creation of Digital Photographic Fine Art Print through the Woodburytype Model.
University of the West of England.
3. Baden Pritchard, H. (1869)
A visit to Asnières. The Photographic Journal. 13 (September 15), pp.151-153.

4. Bedford, W. (1884)
Monthly Technical Meeting, Tuesday April 22 1884. *The Photographic Journal*. 25 (April 25), pp.104-107.
5. Bierstadt, E. (20/08/1875)
On Photo-Mechanical Printing (Part 1). *British Journal of Photography*. XXII .
6. Bird, W.S. (1878)
Remarks on Dr.Monckhovens Paper. *The Photographic Journal*. 18 (April 9), pp.69-72.
7. Blanchard, V. (1875)
On a Method of Enlarging. *The Photographic Journal*. 16 (April 16), pp.111-113.
8. Bolas, T. (1896)
Note as to the Historical Evolution of Photogravure Methods in Intaglio and Relief. *The Photographic Journal*. 36 (May 29), pp.238-241.
9. Bolas, T. (1880)
The Reproduction of Negatives in a Reversed Direction, by the Inverse Action of Light on Gelatine Plates. *The Photographic Journal*. 20 (June 18), pp.127-129.
10. Bolas, T. (16/08/1878)
Extract - The Application of Photography to the Production of Printing Surfaces and Pictures in Pigment. *Photographic News*. XXII .
11. Bolas, T. (13/09/1889)
The Photo-Mechanical Printing Methods as Employed in the Jubilee Year of Photography (Part 2). *British Journal of Photography*. XXXVI .
12. Bolas, T. (06/09/1889)
Extrat - The Photo-Mechanical Printing Methods (Part 2). *Photographic News*. XXXIII .
13. Bolas, T. (06/09/1889)
The Photo-Mechanical Printing Methods as Employed in the Jubilee year of Photography (Part 1). *British Journal of Photography*.
14. Bothamley, C.H. (30/12/1887)
Extract - Photography in 1887. *British Journal of Photography*. XXXIV .
15. *British Journal of Photography* (1896)
Answers to correspondents. *British Journal of Photography*. (October 30), pp.704.
16. *British Journal of Photography* (1896)
Photography with the Bichromated Salts. *British Journal of Photography*. (May 8), pp.204.
17. Brooks, N. (2011)
Advanced Mouldmaking and Casting. 1st ed. Ramsbury: Crowood.

18. Brown, A.P. (2005)
Inks for the Fine Art Printmaker: A System and Methodology for the Development, Testing and Manufacture of Oil-Based Printing Inks for the Fine Art Sector. M.Phil, University of the West of England.
19. Burton, P.W.B. (24/06/1887)
E. Edward's Photo-Mechanical Works, Brooklyn, New York. *Photographic News*. XXXI .
20. Camfield and Wills, D. (1985)
Walter Bentley Woodbury. *The Photographic Journal: Official Organ of the Royal Photographic Society of Great Britain and the Photographic Alliance*. 125 pp.551-554.
21. Caponigro, J.P. (2011)
Toning Black & White. *Popular Photography* (19440510). 75 (9), pp.44-46.
22. Cartier-Bresson, A. (1998)
Methods of producing photographic prints. In: Frizot, M., ed. (1998)
The New History of Photography. Konemann UK Ltd; First English Edition edition (Dec 1998), pp.755-757.
23. Charles, P. and Faujat, S. (1900)
Machine for Production of Gelatine Pictures in Connection with Photography
Anon. .
24. Clarke, A. (06/02/1891)
Photography in Coloured Inks. *British Journal of Photography*. XXXVIII .
25. Close, C. Chuck Close. Two Palms Studios, New York 2012. Available from: http://www.twopalms.us/artists/artist_detail.php?artist_id=18 .
26. Coe, B. and Haworth-Booth, M. (1983)
A Guide to Early Photographic Processes. 1st ed. England: The Victoria and Albert Museum in Association with Hurtwood Press.
27. Cowan, A. (1883)
On Gelatino-Chloride Emulsion in the Camera. *The Photographic Journal*. 23 (March 30), pp.96-100.
28. Crawford, W. (1979)
The Keepers of Light. A History & Working Guide to Early Photographic Processes. 1st ed. New York: Morgan & Morgan Ltd.
29. Curtis, L. (2004)
Electroforming. 1st ed. London: A&C Black Publishers Ltd.
30. Dawson, A. (1892)
Photogravure. *The Photographic Journal*. 32 (June 28), pp.290-297.
31. De Courten, Comte Ludovico M. (15/11/1872)
A Frenchman's Notes on Germany. *British Journal of Photography*. XIX .

32. De Wiveleslie Abney, Sir William (29/05/1896)
Scientific and History Preliminary (Photography with the Bichromate Salts). The Photographic Journal.
33. Debenham, W.E. (1896)
Affiliation of Photographic Societies. Six Lectures on "Photography with the Bichromate Salts" iii)
Collotype. The Photographic Journal. 36 (May 29), pp.265-270.
34. Devulder, G. (05/08/1870)
Some Accounts of an Antwerp Process of Phototypy. British Journal of Photography. XVII .
35. Diamond, H.W. (1867)
Official Reports of the French Exhibition. Class 9, Photographic Proofs and Apparatus, Section 1, Permanent Printing. The Photographic Journal. 12 (October 15), pp.113-120.
36. Dommasch, H.S. and Silversides, B. (1989)
The Silver Image. Cartes De Visites and the Albumen Process. The Photographic Journal. 129 (September), pp.435-437.
37. Editor (1884)
Leipzig Illustrierte Zeitung ("Illustrated News").
38. Edwards, E. (26/05/1871)
On Photography on the Printing Press, Being a Description of the Working of the Heliochrome Process (Part 4). Photographic News. XV .
39. Edwards, E. (1871)
On Photography in the Printing Press, Being a Description of the Working Heliochrome Process. The Photographic Journal. 15 (May 16), pp.76-84.
40. Edwards, E. (15/03/1895)
Photo-Mechanical Printing Processes. British Journal of Photography. XLII .
41. Edwards, E. (15/02/1895)
Photo-Mechanical Printing Processes (Part 1). British Journal of Photography. XLII .
42. Edwards, E. (05/05/1871)
On Photography in the Printing Press, Being a Description of the Working of the Heliochrome Process (Part 1). Photographic News. XV .
43. Elder, D.J.M. (09/07/1886)
Extract - The Progress of Photography in Germany and Austria. British Journal of Photography. XXXVIII .
44. Evans, F.H. (1886)
Photo-Micrography. The Photographic Journal. 26 (December 31), pp.25.

45. Farmer, H. (1892)
Preliminary Note on some Remarkable Properties of Silver and Gelatine. *The Photographic Journal*. 33 (November 25), pp.30-32.
46. Fowler, R.J. (24/05/1867)
The History of the Processes for the Production of Permanent Photographic Pictures in Printers' Inks (Part 2). *British Journal of Photography*. XIV .
47. Frizot, M. (1998)
The New History of Photography. 1 (English)
ed. Koln: Konemann.
48. Gamble, W. (26/03/1897)
The Camera and the Printing Press (Part 2). *Photographic News*. XLI .
49. Gamble, W. (1897)
The History of the Half-Tone Dot. *The Photographic Journal*. 37 (February 20), pp.126-136.
50. Gamble, W. (18/10/1895)
Photo-Mechanical Notes. *British Journal of Photography*. XLII .
51. Gamble, W. (08/10/1897)
The Printing Processes of the Future. *British Journal of Photography*. XLIV .
52. Gascoigne, B. (2004)
How to Identify Prints. A Complete Guide to Manual and Mechanical Processes from Woodcut to Inkjet. 2nd ed. London: Thames & Hudson.
53. Geddes, J.D. (29/05/1869)
Woodburytype Printing (Photography with the Bichromate Salts). *The Photographic Journal*.
54. Geddes, J.D. (1896)
Affiliation of Photographic Societies. Six Lectures on "Photography with the Bichromate Salts" iv)
Woodbury Printing. *The Photographic Journal*. 36 (May 29), pp.270-273.
55. Geddes, J.D. (17/10/1902)
Photography as Applied to Illustrations and Printing (Part 2). *British Journal of Photography*. XLIX .
56. Geddes, J.D. (10/10/1902)
Photography as Applied to Illustration and Printing (Part 1). *British Journal of Photography*. XLIX .
57. Gernsheim, H. and Gernsheim, A. (1987)
The History of Photography Volume II. the Rise of Photography 1850-1880. the Age of Collodion. 3rd ed. London: Thames and Hudson.

58. Gernsheim, H. and Gernsheim, A. (1955)
The History of Photography. from the Earliest use of the Camera Obscura in the Eleventh Century Up to 1914. 1st ed. London: Oxford University Press.
59. Gill, A.T. (1970)
One Hundred Years Ago. The Photographic Journal. 110 (August), pp.334-335.
60. Gill, A.T. (1969)
One Hundred Years Ago. The Photographic Journal. 109 (March), pp.158-159.
61. Gill, A.T. (1969)
One Hundred Years Ago. The Photographic Journal. 109 (October), pp.590-591.
62. Gill, A.T. (1969)
One Hundred Years Ago. The Photographic Journal. 109 (November), pp.619-621.
63. Hannavy, J., ed. (2008)
Encyclopedia of Nineteenth-Century Photography. 1st ed. USA: Routledge.
64. Hanson, D.A. (2005)
John Carbutt and the Woodburytype in America. In: Anon.(2005)
Printing History. New York: American Printing History Association, pp.41-54.
65. Heath, V. (06/03/1874)
The Autotype and other Photographic Processes and Discoveries. British Journal of Photography. XXI .
66. Herbert, E. (2013)
OAM for Alan Elliott ARPS. RPS Journal. 152 (March), pp.68.
67. Herbert, E. (2006)
A Celebratory Tome. RPS Journal. 145 (July / August), pp.258-261.
68. Herbert, E. (2001)
RPS Overseas - Victorian Chapter. G'Day, Australians see (and cook)
it their way. RPS Journal. 141 (April), pp.130.
69. Horgan, S.H. (1929)
Bringing Photography to the Printing Press. The Photographic Journal. 69 (August),
pp.355.
70. Howe Ashton, R. (1867)
Obtaining Printing and Embossing Surfaces. The Photographic Journal. 12
(September 16), pp.108.
71. Howe Ashton, R. (1867)
Printing and Carving Surfaces. The Photographic Journal. 12 (September 16),
pp.108-109.
72. Howe Ashton, R. (1866)
Colouring photo relief prints. Photographic News. X (432 December 14), pp.599.

73. Hume, W. (18/01/1895)
Remarks on Photographic Colour Printing (Part 2). *Photographic News*. XXXIX .
74. I.H.J (10/12/1886)
Photo-Zincotypy and Other Photographic Printing Methods for the Printing Press. *British Journal of Photography*. XXXIII .
75. Ives, F.E. (1900)
The Optics of Trichromatic Photography. *The Photographic Journal*. 41 (November 30), pp.99-120.
76. Jones, C. (30/03/1888)
The Use of Chromated Gelatine in Photo-Lithography, Photo-Zincography, In Collotype, In Getting Gelatine Reliefs. *Photographic News*. XXXII .
77. Kerr, P. Career Resilience. Available from: <http://www.careers.govt.nz/educators-practitioners/career-practice/archive/career-resilience-june-2009> [Accessed 04/05/2015].
78. King, S. (2003)
The Book of Carbon and Carbro. Contemporary Procedures for Monochrome Pigment Printmaking. 1st ed. Greenville, South Carolina: Permanent Light Systems.
79. Kipphan, H. (2001)
Handbook of Print Media. 1st ed. Germany: Springer-Verlag Berlin Heidelberg New York.
80. Krone, M. (12/08/1870)
M. Krone on Albert-Type. *Photographic News*. XIV .
81. Lister, R. (1984)
Prints and Printmaking. A Dictionary and Handbook of the Art in Nineteenth Century Britain. 1st ed. London: Melhuen London Ltd.
82. Melvin, M. (2009)
In the Footsteps of Walter Woodbury. *RPS Journal*. 149 (February), pp.28-31.
83. Mertle, J.S. (1957)
The Woodburytype. The most beautiful photographic reproduction process ever invented. *Image.the Journal of Photography and Motion Pictures of the George Eastman House*. 53 (September), pp.165-170.
84. Nadeau, L. (1986)
Modern Carbon Printing: A Practical Guide to the Ultimate in Permanent Photographic Printing: Monochrome Carbon Transfer and Carbro [online]. Fredericton, New Brunswick: Atelier Luis Nadeau.

85. Nadeau, L. Encyclopedia of Printing, Photographic, and Photomechanical Processes: A Comprehensive Reference to Reproduction Technologies, Containing Invaluable Information on Over 1500 Processes [online]. Fredericton, N.B., Canada : L. Nadeau, c1989-c1990.
86. Newhall, B. (1964)
The History of Photography. 1st ed. New York: The Museum of Modern Art, New York.
87. Newton, A.J. (1913)
The Evolution of Photomechanical Illustration. The Photographic Journal. 53 (June), pp.206-212.
88. Newton, G. (2007)
Leo Haks: Indonesian photographs collection 1860s-1940s. Artonview [online]. (52), pp. 36-41.
89. Newton, G. (2007)
Serimpies, or dancing girls of the Sultano. Artonview [online]. (50), pp. 49-49.
90. Oliver, B. (2006)
A History of the Woodburytype. Carl Mautz Publishing.
91. Ott, A. (25/06/1880)
Examination and Selection of Gelatine for Photo-Mechanical Printing. Photographic News. XXIV .
92. Photographic Journal (1867)
The Photographic Journal. (January 15), pp.177.
93. Photographic News (1877)
M.Lambert and Carbon in the United States. Photographic News. XXI (January 19), pp.30.
94. Photographic News (1877)
New Combination Process. Photographic News. (May 11), pp.P228.
95. Platzker, D. and Wyckoff, E. (2000)
Hard Pressed: 600 Years of Prints and Process [online]. New York: Hudson Hill Press.
96. Pritchard, H.B. (26/08/1870)
The Woodbury and the Lichtdruct Processes Compared. Photographic News. XIV .
97. Pritchard, H.B. (1869)
Our Printing Processes in the Future. The Photographic Journal. 14 (September 15), pp.113.
98. Sanger Shepherd, E. (1897)
A Review of Triple Printing Methods. The Photographic Journal. 38 (December 24), pp.96-103.

99. Sawyer, J.R. (1501/1872)
Phorography in the Printing Press. *The Photographic Journal*.
100. Schmidt, K.F. (1971)
Continuous-tone lithography. *Print* (New York)
[online]. 25 pp.70.
101. Schnauss, H. (01/01/1901)
A New Modification of Woodburytype. *Penrose Pictorial Annual*.
102. Sinclair, J.A. (1896)
Affiliation of Photographic Societies. Six Lectures on "Photography with the
Bichromate Salts" ii)
Carbon Printing. *The Photographic Journal*. 36 (May 29), pp.259-265.
103. Smith, G. (1886)
On the Production of Transparencies for the Optical Lantern by the Woodbury
Process. *The Photographic Journal*. 26 (December 31), pp.22-25.
104. Spiller, J. (1883)
Monthly Technical Meeting. *The Photographic Journal*. 23 (March 30), pp.100-101.
105. Sutton, T. (25/10/1872)
A Visit to the Works of the Heliotype Company, at Kilburn. *British Journal of
Photography*. XIX .
106. Sutton, T. (15/11/1872)
Correspondence - The Woodburytype; Comparison Between it and the Heliotype
[Suggested use of the Latter in Portraiture]. *British Journal of Photography*. XIX .
107. Sutton, T. (12/12/1873)
Correspondence - M. Lemerrier's Albertypes; The Autotype Company's Lictdruct
Specimens. *British Journal of Photography*. XX .
108. Sutton, T. (01/03/1870)
A Week at the Woodbury - Printing Establishment of MM. Goupil at Ansieres, near
Paris. *The Photographic Art Journal*.
109. Swan, J. (19/05/1865)
Mr. Swan's Claim Versus Mr. Woodbury's. *British Journal of Photography*. XII .
110. Swan, J. (1878)
Letter to Mr Bird. *The Photographic Journal*. 18 (April 9), pp.72-73.
111. Swan, J. (05/05/1865)
Mr. Swan's Claim Versus Mr. Woodbury's. *British Journal of Photography*. XII .
112. Swan, J. (1864)
A New Method of Carbon Printing. *The Photographic Journal*. (April 15), pp.20.

113. The Royal Photographic Society, Victorian Chapter (2008)
Walter Woodbury. A Victorian Study. 1st ed. Melbourne, Australia: RPS Victorian Chapter.
114. Thirkell, P., ed. (2004)
Altered Images Digital Interpretations Inspired by George Cartlidge's Portrait Tiles. Bristol: MakingSpace Publishers.
115. Thirkell, P. (2000)
The Integration of Digitally Mediated Imaging Techniques with 19th Century Continuous Tone Printing Processes. University of the West of England.
116. Thomas, R.W. (1870)
Is it possible to obtain Photographs in Colours? The Photographic Journal. 14 (December 16), pp.44.
117. Thomson, J: Smith, A (1876c) Street life in London
Sampson Low, Marston, Searle, & Rivington
digital.library.lse.ac.uk/assets/street_life_in_london.pdf
118. Tissandier, G. (01/01/1876)
A History and Handbook of Photography (Part II, Chapter II). A History and Handbook of Photography.
119. Traill Taylor, J. (1888)
Tuesday, August 28th, 1888. J. Traill Taylor, Member of Council, in the Chair. The Photographic Journal. 29 (November 30th), pp.19-20.
120. Tritton, F.J. (1949)
Photography in Book Production. The Photographic Journal. 89 (November), pp.252-256.
121. Trueman Wood, H. (03/02/1888)
Photography and the Printing-Press. Amateur Photographer. VII .
122. Unknown (30/11/1877)
Photo-Collotype Pictures in Colour. Photographic News. XXI .
123. Unknown (30/09/1892)
Photo-Mechanical Work. British Journal of Photography. XXXIX .
124. Unknown (2936)
Reviews - Die Photoplastik. The Photographic Journal. 62 (August), pp.410-411.
125. Unknown (29/04/1898)
Extract - The International Photographic Exhibition, Crystal Palace, April 25 - May 14. Sections III & IV, Apparatus & Material & Photo-Mechanical. British Journal of Photography. XLV .
126. Unknown (29/04/1870)
Extract - An Indian Photographer on the Continent; The Photoype Process of MM. Tessié Du Motay and Maréchal. British Journal of Photography. XVII .

127. Unknown (28/12/1883)
Some Suggestions as to the Future of Photo-Mechanical Printing Methods. Photographic News. XXVII .
128. Unknown (28/10/1870)
On Alberttype and Relief Printing. British Journal of Photography. XVII .
129. Unknown (28/05/1880)
Mr. Woodbury's New Process: Hints on Making Reliefs. British Journal of Photography. XXVII .
130. Unknown (25/08/1865)
Printing Photographs from Metal Plates. British Journal of Photography. XII .
131. Unknown (25/07/1884)
Printing Photographs By Machinery. Photographic News. XXVIII .
132. Unknown (25/04/1884)
The Effect of Heat on Bichromated Gelatine while in a Fluid Condition. British Journal of Photography. XXXI .
133. Unknown (25/03/1887)
Printing Collotypes at the Machine: A Visit to Waterlow & Sons, Limited. Second Article. Photographic News. XXXI .
134. Unknown (25/01/1895)
Photo-Mechanical Exhibition at New York. Photographic News. XXXIX .
135. Unknown (24/12/1891)
Photo-Mechanical Printing in Colours. British Journal of Photography. XXXVIII .
136. Unknown (24/08/1877)
Collotype Printing. Photographic News. XXI .
137. Unknown (24/07/1885)
Some Easy Ways of Making Grain Plates or Surfaces for Photo-Mechanical Processes. Photographic News. XXIX .
138. Unknown (23/12/1870)
M. Grasshoff on the Albert and Woodbury Processes. Photographic News. XIV .
139. Unknown (23/07/1880)
Gelatino-Bromide Negatives for Photo-Mechanical Printing. Photographic News. XXIV .
140. Unknown (23/04/1875)
Recent Advances in Photographic Science. British Journal of Photography. XXII .
141. Unknown (21/05/1880)
Mr. Woodbury' New Method of Photoglyptic Printing. British Journal of Photography. XXVII .

142. Unknown (21/05/1880)
Mr. Woodbury's New Proces. . XXVII .
143. Unknown (21/03/1884)
The Woodbury Process: Third Article. Photographic News. XXVIII .
144. Unknown (20/10/1865)
The New Printing Process - A Day With Mr. Woodbury. British Journal of Photography. XII .
145. Unknown (1996)
Groups & Regions - Victorian Chapter Australia. The Photographic Journal. 136 (November), pp.476.
146. Unknown (1996)
News of Members - Alan Elliott. The Photographic Journal. 136 (November), pp.495.
147. Unknown (1986)
Walter Bently Woodbury - Amendium. The Photographic Journal. 126 (January), pp.40.
148. Unknown (1985)
Walter Bently Woodbury - A Monogram. The Photographic Journal. 125 (December), pp.551-554.
149. Unknown (1930)
Proposed Memorial to the Memory of the Late Sir Joseph Wilson Swan FRS. DSC Progress Medalist of The Royal Photographic Society of Great Britain. The Photographic Journal. 70 (December), pp.538-539.
150. Unknown (1907)
Ordinary Meeting. The Photographic Journal. 47 (December), pp.401-409.
151. Unknown (1906)
Obituary - The Late Leon Vidal. The Photographic Journal. 46 (October), pp.316-317.
152. Unknown (19/11/1875)
Proceedings of Societies - South London Technical Exhibition. Photographic News. XIX .
153. Unknown (1899)
Acrograph Engraving Machine. The Photographic Journal. 39 (May 31), pp.249-251.
154. Unknown (1894)
Untitled. The Photographic Journal. 35 (October 22), pp.27.
155. Unknown (1893)
(Untitled) Photoplastography. The Photographic Art Journal. 33 (April 26), pp.197-203.

156. Unknown (1891)
Ghent - (Details of School). *The Photographic Journal*. 32 (November 27), pp.35.
157. Unknown (1885)
Notes - Historical Collection by the Photographical Society of Great Britain at the International Inventions Exhibition. *The Photographic Journal*. 25 (June 26), pp.186-170.
158. Unknown (1885)
WB Woodbury Fund. *The Photographic Journal*. 25 (Vol IX) (April 24), pp.126.
159. Unknown (1883)
Tresurers Report 1882. *The Photographic Journal*. 23 (February 23), pp.181.
160. Unknown (1875)
Photography in Permanent Pigments with Recent Improvements in Autotype Transfer. *The Photographic Journal*. 16 (April 16), pp.113-117.
161. Unknown (1875)
Report of the Council. *The Photographic Journal*. 16 (February 16), pp.97-98.
162. Unknown (1874)
The Electric Light in Photography. *The Photographic Journal*. 16 (April 21), pp.54.
163. Unknown (1874)
Reviews. *The Photographic Journal*. 16 (February 17), pp.35.
164. Unknown (1874)
To Duplicate Negatives by the Wet Process. *The Photographic Journal*. 16 (April 21), pp.54.
165. Unknown (1872)
Photography in the Printing Press. *The Photographic Journal*. 15 (January 15), pp.108-113.
166. Unknown (1870)
Report of the Council. *The Photographic Journal*. 14 (February 14), pp.199-202.
167. Unknown (1869)
Exhibition Notices: Groningen. *The Photographic Journal*. 14 (August 16), pp.93.
168. Unknown (1869)
Miscellaneous. *The Photographic Journal*. 14 (September 15), pp.127.
169. Unknown (1869)
Miscellaneous: The Woodburytype Company. *The Photographic Journal*. 13 (January 16), pp.218.
170. Unknown (1869)
The Permanence of Carbon Prints. *The Photographic Journal*. 14 (October 15), pp.130.

171. Unknown (1869)
Prize Competition in Carbon Photography. *The Photographic Journal*. 14 (August 16), pp.91.
172. Unknown (1869)
Report of Council. *The Photographic Journal*. 13 (February 16), pp.224.
173. Unknown (1868)
Modified Carbon Tissue. *The Photographic Journal*. 13 (March 16), pp.17.
174. Unknown (1868)
Report of the Council. *The Photographic Journal*. 12 (February 17), pp.184.
175. Unknown (1867)
Report of the Commission of the French Photographic Society for Awarding the Prize of 8000 Francs by the Duc De Luynes for Printing Photographs in Ink. *The Photographic Journal*. 12 (July 16), pp.64-78.
176. Unknown (1867)
Swan's Carbon Process. *The Photographic Journal*. 12 (July 16), pp.77.
177. Unknown (1866)
The Carbon Process in France. *The Photographic Journal*. 11 (October 15), pp.134.
178. Unknown (1866)
Improvement in Photo-Relief Printing. *The Photographic Journal*. 11 (August 15), pp.102.
179. Unknown (1866)
Review. Photography: Its History and Applications. *The Photographic Journal*. 11 (October 15), pp.129-134.
180. Unknown (1865)
New Method of Photo-Relievo Printing. *The Photographic Journal*. 10 (September 15), pp.150-153.
181. Unknown (1865)
North London Photographic Association. *The Photographic Journal*. 10 (November 16), pp.188.
182. Unknown (1865)
North-Eastern London Exhibition. Report of the Jurors of the Photographic Department. *The Photographic Journal*. 10 (September 15), pp.148-149.
183. Unknown (1865)
Photographic Society. *The Photographic Journal*. 10 (December 15), pp.201-202.
184. Unknown (18/07/1879)
Photo-Mechanical Printing for Trade Purposes. *British Journal of Photography*. XXVI .

185. Unknown, (1896)
Answers to Correspondents. *British Journal of Photography*. (January 17), pp.48.
186. Unknown, (1871)
The Photographic Journal. 225 (May 16), pp.81.
187. Unknown, (1869)
Miscellaneous. *The Photographic Journal*. 13 (January 16),
pp.218.
188. Unknown, (1867)
The Times on the great French exhibition. *The Photographic Journal*. 11
(November 16),
pp.134-140.
189. Unknown, (1865)
New Method of Photo-relivo Printing. *The Photographic Journal*. (September 15),
pp.150-153.
190. Unknown, (1865)
A New Photo-Relief Printing Process. *The Photographic Journal*. (Decemberr 15),
pp.202.
191. Unknown, (1864)
A New Method of Carbon Printing. *The Photographic Journal*. (April 15), pp.20-25.
192. Unknown (17/07/1885)
Photo-Mechanical Processes of Ilustration. *British Journal of Photography*. XXXII .
193. Unknown (17/03/1899)
As many of our readers may not be acquainted with the variety of gelatines....
British Journal of Photography. XLVI .
194. Unknown (16/11/1883)
The Woodbury Process: Second Article. *Photographic News*. XXVII .
195. Unknown (16/03/1888)
The Camera Club Conference - Mr. G.S. Waterlow's Paper. *Amateur Photographer*.
VII .
196. Unknown (15/12/1865)
The Discover of the Action of Light on Gelatine. *The Photographic Journal*.
197. Unknown (15/12/1865)
Mr. Woodbury's Photo-Relievo Process. *The Photographic Journal*.
198. Unknown (15/01/1874)
The Correlation of Photography, Lithography, and Typography: The
Woiodburytype Process. *The Lithographer*.
199. Unknown (14/09/1883)
The Woodbury Process: First Article. *Photographic News*. XXVII .

200. Unknown (13/04/1893)
Extract - Messrs. Waterlow & Sons' Photo-Mechanical Printing Works. British & Colonial Printer & Stationer. XXXI .
201. Unknown (12/07/1889)
Photographs in Printers' Ink. Amateur Photographer. X .
202. Unknown (11/11/1870)
On Heliochrome as a Means of Reproducing Works of Art (Part 1). Photographic News. XIV .
203. Unknown (11/10/1872)
Heliochrome Printing at Chatham. Photographic News. XVI .
204. Unknown (11/07/1890)
So much interest is now being.... Amateur Photographer. XII .
205. Unknown (11/03/1870)
New Photo-Engraving Process. Photographic News. XIV .
206. Unknown (10/04/1884)
The Woodbury Process: Fifth Article. Photographic News. XXVIII .
207. Unknown (10/03/1893)
How Businesses May be Revived. British Journal of Photography. XL .
208. Unknown (09/05/1879)
Photo-Collographic Printing - The Artotype Process. Photographic News. XXIII .
209. Unknown (09/01/1885)
Photo-Mechanical Printing for Amateurs. British Journal of Photography. XXXII .
210. Unknown (08/10/1897)
Historical Photographs in the Photographic Section of the Imperial Victorian Exhibition at the Crystal Palace (V). British Journal of Photography. XLIV .
211. Unknown (06/08/1886)
Extract - Photography in Belgium. British Journal of Photography. XXXIII .
212. Unknown (05/02/1869)
Herr Albert's New Mechanical Printing Process. Photographic News. XIII .
213. Unknown (05/01/1894)
Amateur Photographer Foreword - Photo-Mechanical Processes. Amateur Photographer. XIX .
214. Unknown (04/10/1867)
Contemporary Press - Remarks on the Photographs in the French Exhibition. British Journal of Photography. XIV .
215. Unknown (04/04/1884)
The Woodbury Process: Fourth Article. Photographic News. XXVIII .

216. Unknown (04/01/1878)
Recent Patents - No.1 - Photographic Plates for Printing. British Journal of Photography. XXV .
217. Unknown (03/06/1887)
Fifty Years Development of the Graphic Arts. Amateur Photographer. V .
218. Unknown (03/03/1871)
Correspondence - The age of discovery in photography is almost, if not altogether, passed away.... British Journal of Photography. XVIII .
219. Unknown (02/09/1870)
Mr. Edwards' Photo-Collographic Process. Photographic News. XIV .
220. Unknown (02/05/1884)
The Woodbury Process: The Sixth Article. British Journal of Photography. XXVIII .
221. Unknown (01/06/1870)
Editorial. The Photographic Art Journal.
222. Unknown (01/01/1875)
Extract - The Past Year. British Journal of Photography. XXII .
223. van Pottelsberghe de la Potterie, Bruno (2010)
Patent fixes for Europe. Nature [online]. 467 (7314), pp.395-395.
224. Vidal, L. (20/06/1879)
French Correspondence - Phototypie at the Meeting of the Photographic Society of France. Photographic News. XXIII .
225. Vidal, L. (1891)
Photographic Methods of Obtaining Polychromatic Impressions. The Photographic Journal. 31 (May 22), pp.146-153.
226. Vidal, L. (11/07/1890)
Photography in France - Collographic Process by M. Balagny. Photographic News. XXXIV .
227. Vogel, D.H. (25/06/1869)
The Albert Process and its Practical Value. Photographic News. XIII .
228. Vogel, D.H. (15/10/1869)
German Correspondence - The Albert Prints Compared With Those by the Woodbury Processes. British Journal of Photography. XVI .
229. Wall, E.J. (27/07/1894)
Photography in Colours (Part 2). Photographic News. XXXVIII .
230. Wall, E.J. (1894)
Photography in Colours. The Photographic Journal. 34 (June 26), pp.290-297.

231. Warnerke, L. (1881)
A New Discovery Regarding Gelatine Emulsion. *The Photographic Journal*. 21 (May 20), pp.122.
232. Warnerke, L. (1881)
On Sensitometers. *The Photographic Journal*. 21 (February 18), pp.75-82.
233. Warnerke, L. (1879)
On Actinometers. *The Photographic Journal*. 20 (December 20), pp.19-29.
234. Wastell, W.L.F. (1922)
The Evolution of the Lantern Slide. *The Photographic Journal*. 62 (December), pp.494-507.
235. Waterhouse, M.J. (01/07/1892)
Early Photo-Mechanical Printing Processes. *British Journal of Photography*. XXXIX .
236. Waterhouse, M.J. (1880)
On a New Method of Obtaining "Grain" in Photo Engraving. *The Photographic Journal*. 21 (November 19), pp.20-21.
237. Waterlow, G.S. (30/03/1888)
Modern Photographic Engraving and Printing (Part 2). *Photographic News*. XXXII .
238. Waterlow, G.S. (23/03/1888)
Modern Photographic Engraving and Printing (Part 1). *Photographic News*. XXXII .
239. Waterlow, P. and Geddes, J.D. (15/04/1892)
Extract - Photography and Photo-Mechanical Printing (Part 1). *Photographic News*. XXXVI .
240. Waterlow, P. and Geddes, J.D. (15/04/1892)
Extract - Photography and Photo-Mechanical Printing (Part 2). *British Journal of Photography*. XXXIX .
241. Whaite, T.G. (1886)
Our Illustration - Market Place at Dinant. *The Photographic Journal*. 26 (Mar 26), pp.112-113.
242. Wilkinson, B.G. (1887)
Our Illustration - Fishing Boats - Rye Sussex. *The Photographic Journal*. 28 (December 30), pp.40-41.
243. Wilkinson, W.T. (29/05/1896)
Process Application of the Bichromate Salts (Photography with the Bichromate Salts). *The Photographic Journal*.
244. Wilkinson, W.T. (1896)
Affiliation of Photographic Societies. Six Lectures on "Photography with the Bichromate Salts" v)
Photo-Lithography and Photozincography. *The Photographic Journal*. 36 (May 29), pp.273-277.

245. Wilkinson, W.T. (1896)
Affiliation of Photographic Societies. Six Lectures on "Photography with the Bichromate Salts" vi)
Process Application of the Bichromate Salts. *The Photographic Journal*. 36 (May 29), pp.277-281.
246. WILLS, C. and WILLS, D. (1985)
WALTER BENTLEY WOODBURY. *Photographic Journal*. 125 (125), pp.551-554.
247. Wilson, E.L. (21/01/1870)
American Correspondence - Woodburytypes. *Photographic News*. XIV .
248. Wilson, E.L. (07/01/1870)
Photography in America. *Photographic News*. XIV .
249. Winstanley, D. (24/06/1887)
Photography on Colours. *British Journal of Photography*. XXIV .
250. Winstanley, D. (12/07/1867)
The Solubility of Chromated Gelatine Salts. *British Journal of Photography*. XIV .
251. Winstanley, D. (03/08/1888)
Photo-Mechanical Printing. *Photographic News*. XXXII .
252. Wisker, G. (2001)
The Postgraduate Research Handbook: Succeed with Your MA, MPhil, EdD and PhD [online]. Basingstoke: Palgrave.
253. Woodbury, W.B. (25/02/1870)
Recent Patents - Photo-Relief Printing. *Photographic News*. XIV .
254. Woodbury, W.B. (24/05/1867)
Recent Patents - Photo-Relief Printing by Machinery. *Photographic News*. XI .
255. Woodbury, W.B. (1880)
Modified Woodbury Type Process. *The Photographic Journal*. 20 (May 21), pp.118-120.
256. Woodbury, W.B. (1875)
Carbon Lantern Slides. *British Journal Photographic Almanac and Photographer's Daily Companion*.
257. Woodbury, W.B. (1874)
My Experiences in Producing Negatives in Plumbago. *The Photographic Journal*. 16 (May 27), pp.63-65.
258. Woodbury, W.B. (1872)
Photo-Engraving: A New Method. *British Journal Photographic Almanac and Photographer's Daily Companion*.

259. Woodbury, W.B. (1870)
Improvements in Photo-Press Printing. British Journal Photographic Almanac and Photographer's Daily Companion.
260. Woodbury, W.B. (1869)
Description of the Woodburytype, or Photo-Relief Process. The Photographic Journal. 14 (Mar 16), pp.4.
261. Woodbury, W.B. (1867)
On a Method of Obtaining Imperishable Photographs. British Journal Photographic Almanac and Photographer's Daily Companion.
262. Woodbury, W.B. (1865)
A New Photo-Relief Printing Process. The Photographic Journal. 10 (December 15), pp.202-207.
263. Woodbury, W.B. (18/08/1865)
The New Photo-Relief Printing Process In Semi-Transparent Ink. Photographic News. IX .
264. Woodbury, W.B. (16/03/1869)
Description of the Woodburytype, or Photo-Relief Process. The Photographic Journal.
265. Woodbury, W.B. (15/12/1865)
A New Photo-Relief Printing Process. The Photographic Journal.
266. Woodbury, W.B. (10/07/1874)
Recent Patents - Photo Block Printing. Photographic News. XVII .
267. Woodbury, W.B. (09/07/1869)
Improvements in Photo-Press Printing. British Journal of Photography. XVI .
268. Woodbury, W.B. (04/10/1872)
Mechanical Printing. British Journal of Photography. XIX .
269. Woodbury, W.E. (20/08/1886)
Photography in Germany - Lichtdruck (Collotype) Printing. Photographic News. XXX .
270. Woodbury, W.E. (01/01/1898)
Stannotype. The Encyclopaedic Dictionary of Photography.
271. Woodbury, W.B. (1880)
Woodbury's New Photoglyphic Process. British Journal of Photography. 27 (May 14), pp.233.
272. Woodbury, W.B. (1869)
Description of the Woodburytype, or Photo-relief process. The Photographic Journal. 14 (March 16), pp.4-5.

273. Woodbury, W.B. (1866)
Printing photo-relievo photographs with white margins. *Photographic News*. (November 9), pp.534.
274. Woodbury, W.B. (1865)
Woodbury's New Printing Process. *British Journal of Photography*. 12 (134), .
275. Woodbury, W.B. (1864)
An Improved Method of Producing Or Obtaining by the Aid of Photography Surfaces in 'Relievo' and 'Intaglio' upon Aluminous, Vitreous, Metallic, Or Other Suitable Materials Anon. .
276. Woodbury, W.B. (17/03/1865)
Woodbury's New Printing Process. *British Journal of Photography*. XII .
277. Woodbury, W.B. (15/12/1865)
Photo-Relief Printing. . XII .
278. Woodbury, W.B. (12/05/1865)
Mr. Swan's Claim Versus Mr. Woodbury's. *British Journal of Photography*. XII .
279. Woodbury, W.B. (12/05/1865)
New Patent: Complete Specification of Patent Obtained by Walter Bently Woodbury, Manchester, filed 23rd March, 1865. *British Journal of Photography*. XII.
280. Woodbury, W.B. (01/01/1869)
How to Transfer a Negative Film. *British Journal Photographic Almanac and Photographer's Daily Companion*.
281. Wortley, Stuart H. Lieut. Colonel (25/08/1871)
Extract - Official Report of Photography in the International Exhibition of 1871. *British Journal of Photography*. XVIII .

A4.4 Historical recipes

As the initial stages of the Woodburytype and the Carbon process are the same recipes for carbon tissues and carbon tissue sensitisers are included.

The Apothecaries system has 12 ounces to the pound and the Avoirdupois (avdp) system has 16 ounces to the pound. Conversion between the systems is not as straight forward as it appears. Converting the weight in pounds (℔ - apothecary symbol) (lbs) to the corresponding weight values in Ounces (℥ - apothecary symbol) (oz) is problematic as the ounces were not equal in weight as are the smaller unit denominations that were used too, Drachms (ʒ - apothecary symbol), Scruples (ʒ - apothecary symbol) and Grains (gr). Only the smallest unit grains appeared to be the same^{[1]*}. The Avoirdupois system has 7000 grains to the pound and the Apothecaries system (and Troy system) had 5760 grains to the pound.

A4.4.1 Tissue and Sensitiser Recipes

A4.4.2 A New method of carbon printing, Joseph Swan

April 15 1864 Photographic Journal p21

Sensitised Tissue Mix

Water mix: 1:3

Gelatine: 2pts

Sugar: 1pt

Water: 8pts

Solution of bichromate of Ammonia: 1pt

Colouring Mix

Indian ink, or indian ink & carmine and indigo

¹ * approximately 0.0648 gram because originally the weight was equivalent to that of a grain of corn.

A4.4.3 Swans Proces for Preparing Carbin positive pictures, Dr. G. Lunge

Sept 15 1866 Photographic Journal P113

Tissue Mix

Gelatine: 2pts

Water: 8pts

Sugar: 1pt

Colouring Mix**Sensitiser**

10pts of tissue mix is added to 1pt solution of bichromate of potassium

A4.4.4 Printing in permanent pigments

Extract from Mr Swans Carbon process – Yearbook of Photography

April 15 1867 Photographic Journal p29

Tissue

Tissue is pre-bought and sensitised

Sensitiser

1oz: bichromate of potash salts

10oz: water.

A4.4.5 Carbon printing by M. Jeanregnaud

Extract from a French Modification – taken from M. Davanne’s published annuaire.

May 16 1868 Photographic Journal p 50

Tissue mix

100g: Gelatine

Water: 1000cm³

Glycerine: 25cm³

Glue (Optional): 20 – 25g

Colouring matter

Sensitiser

Bichromate of potash: 3pts

Water: 100pts

Pure glycerine: 1-2pts

Notes

Don’t use the finest gelatine as it is not soluble enough. Pale yellow sheets sold at 1s6d are the best

If you use finest ¼ of the quantity of glue added.

A4.4.6 Observations of the Carbon process by M. Jeanraud

15 Oct 1868 Photographic Journal p142

Tissue Mix

Gelatine: 60–70g

Water: 1000 cm³

Glycerine: 20cm³

Glue: 20 – 25g of gelatine (Optional)

Glycerine 1: 2%

Ammonia: 1cm³

Sensitiser

Bichromate of Ammonia 3% strength in Winter

Bichromate of Ammonia 2 % strength in Summer

Notes

Do not use superior colourless gelatine

Use yellow cheaper sheets 3 ½ - 4 f

A4.4.7 Patent 23rd September 1864

Photographic News – Oct 14 1864

British Journal of Photography 05 May 1865 & Republished 12/05/1865

Sensitised Tissue Mix

Sugar: 1pt

Gelatine: 8pts

Bichromate of Ammonia: 10 grains

Water: 10oz

Notes

Solution of Gelatine and Sugar Dissolved and clarified with Albumen and filtered

A4.4.8 The new photo-relief printing process in semi-transparent ink

WB Woodbury

Photographic News 18 Aug 1865 VOL X

Tissue Mix

Gelatine: 2oz

White Sugar: $\frac{3}{4}$ oz

Water: 6oz

Clarify with egg if necessary and strain

Sensitiser

Gelatine and sugar solution: 4oz

Bichromate of Ammonia: 60grains dissolved in 1oz water.

A4.4.9 Printing Photographs from metal plates

British Journal of Photography XII – 25 August 1865

Tissue Mix

Gelatine: 2oz

Lump Sugar: $\frac{3}{4}$ oz

Water: 6oz

Sensitiser

Gelatine and sugar solution: 4oz

Bichromate of Ammonia: 60grains dissolved in 1oz water.

Notes

Patentee has altered the proportions of ingredients

A4.4.10 The application of photography to the production of printing surfaces and pictures in pigment

Thomas Bolas

Photographic News XXII 16 Aug 1878

Tissue

Gelatine (easily soluble): 6pts

Lump sugar: 2pts

Warm water: 15 parts

Sensitiser

3.5% Solution potassium bichromate

A4.4.11 Woodburys New Process

Walter Bentley Woodbury

British Journal of Photography XII 14 March 1880

Tissue Mix

Gelatine 200pts

Water 1000pts

Glycerine 20pts

White Sugar 30pts

Little ink

Sensitiser

Bichromate of potash 6%

A4.4.12 The Woodbury Process: Second Article

Photographic News XXVII 16 November 1883

Sensitised Tissue Mix

Gelatine: 1 $\frac{3}{4}$ oz

Water: 4 $\frac{1}{2}$ oz

Sugar: $\frac{1}{2}$ oz

Ammonia Solution: 5 drops

Glycerine: 50 grains

Phenol: 1 drop

India ink (rubbed up): 1 grain in 1 $\frac{1}{2}$ oz water

Ammonia bichromate: 150g

A4.4.13 Extract Photography and Photomechanical Printing part 2

Paul Waterlow and JD Geddes

British Journal of Photography XXXIX 15 April 1892

Sensitised Tissue Mix

Gelatine: 4 pts

Lump sugar: 2pts

Water: 15 pts

Bichromate of Potash: 1pt

A4.4.14 Burtons Method

British & Colonial Printers and Stationer XXXI 13 April 1893

Sensitised Tissue Mix

Nelsons Gelatine Sheet: 3½ oz

Sugar: 1oz

Glycerine: 100g

Phenol: 2 minims

Indian ink: 2 grains

Ammonia: 60 minims

Bichromate of ammonium: 300g

Water: 120 oz

A4.4.15 Woodburytype printing – Photography with the bichromate salts

JD Geddes

Photographic Journal 29 May 1896

Tissue Mix

Gelatine: 2 parts

Glycerine or sugar: ½ pt

Potassium bichromate: 2pts

Water: 15parts

(15% bichromate)

A4.4.16 The book of Carbon and Carbro Sandy King 2003**Notes:**

Refer to King's book about the process as it is a contemporary text and available.

A4.4.17 Keepers of Light Method

Crawford

Average sensitiser for Carbon Printing

Ammonium Dichromate: 6g

Water: 200ml

A4.4.18 Mode of Printing Photographs

US Patent 52803 Feb 20 1866 - Walter Bentley Woodbury

Tissue Mix

Solution

Water

Sugar 1pt

Gelatine 8pts

Albumen

Sensitiser

For Every 10oz add 10grains of Bichromate of Ammonia in solution

A4.4.19 Correspondence – Carbon Printing - Special Correspondent

Photographic News 261 June 1st 1866

Sensitised Tissue

Gelatine: 10g

Distilled Water: 90g

Bichromate of Ammonia: 125g

Liquid Indian Ink: 18g

A4.4.20 Carbon Printing No1 Preliminary experiments - Nelson M Cherill

Photographic News 1866 Sept 28 1866 p460

Bottled water: 16oz

Gelatine: ¼ lb

Sugar (saturated solution): ½oz

Pigment: Decant off 12 – 16 dr add 2-4 inches of pigment from watercolour tubes

Sensitiser

Bathe in solution of bichromate

A4.4.21 Smet**Carbon Printing - René Smets**

Photographic printing process developed in 1855, and adapted in 2010 to current products and equipments.

Notes:

Refer to Smets website for details <http://www.picto.info/>

A4.4.22 Book of Modern Carbon Printing

A contemporary approach to the classic hand made carbon print

The Bostick & Sullivan

Notes:

Refer to www.bostick-sullivan.com and www.carbonprinting.com about the process as it is a contemporary text and live website.

A4.4.23 Nadeau**A4.4.24 Gum Dichromate and Carbon Processes - Nadau****A4.4.25 Modern Carbon Printing - Nadau****Notes:**

Refer to Nadeau's books about the process as they are contemporary texts and available.

A4.4.26 Woodburys Encyclopaedic dictionary**Carbon Print****A4.4.27 HJ Burtons sensitizing method**

Potassium Dichromate: 4oz

Liq Ammonia Fort: 1oz

Water: 20oz

A4.4.28 Dr Gunthers Formula**Carbon Tissue**

Gelatine: 5oz

Isinglass: ½oz

Water: 70oz

Lampblack: ¼oz

English Red (Peroxide of Iron): 1oz

Glycerine: 1½oz

A4.4.29 A Manual of the Carbon Process by Dr Paul E Liesegang**Tissue Mix**

Water: 1oz

Gelatine: 120 to 150 gr

Soap: 15gr

Sugar: 21gr

Colouring Matter: 4 to 8gr

Note

Sugar and soap are added to prevent the tissue becoming brittle in dry weather

A4.4.30 Woodburytype

From Photographic News Sept 14th 1883

Sensitised tissue mix (Bichromate of Amonia)

Nelsons Transparent Sheet Gelatine: 3½oz

Sugar: 1oz

Glycerine: 100grains

Phenol: 2 minims

Indian Ink: 2 grains

Ammonia (880): 60 minims

Bichromate of Amonia: 300 grains

Water: 12 oz

Sensitised tissue mix (Potassium Bichromate)

Nelsons Gelatine: 4oz

Sugar: ¼oz

Glycerin: 100grains

Phenol: 2 minims

Indian Ink: 2 gr

Potassium Bichromate: 200 gr

Water: 12oz

A4.4.31 A new treatise on the modern methods of carbon printing

(Second Edition) A.A. Marton 1905

A4.4.32 Sensitised Tissue Mix

Bichromate of Potash: 3oz

Water: 100oz

Carbonate of Ammonia: 70 gr

A4.4.33 Sensitised Tissue Mix (Summer)

Bichromate of Potash: 2oz

Water: 100oz

Carbonate of Ammonia: 70 gr

Alcohol: 4oz

Note

To prevent reticulation in hot weather add:

Bichloride of mercury: Few drops (10% solution)

Salicylic acid: 100gr

A4.4.34 Sensitised Tissue Mix (Extreme conditions)

Coat the tissue with 1.5% collodion

A4.4.35 Sensitised Tissue Mix (Winter or Dense Negatives)

Bichromate of Potash: 6oz

Distilled Water: 100oz

Accelarine: 150 gr

Ammonia (liq): 2 dr

Notes

Dissolve in hot water and filter through muslin

Heavy negatives: 4 mins, med negatives 3 mins

A4.4.36 Sensitised Tissue Mix (Any Climate)

Bichromate of Potash: 2oz
 Bichromate of Ammonia: 2oz
 Ammonia (liq): 2dr
 Accelorine: 100gr
 Water (distilled): 128oz

Notes

In summer dilute with an equal quantity of water and add
 Sugar: 2 to 4 oz

A4.4.37 Sensitised Tissue Mix (Excessively Hot Climate)

Bichromate of sodium: 2oz
 Water: 100oz
 Ammonia (liq): 120 mins
 Citric Acid: 100gr
 Salicylic acid: 50 grains

A4.4.38 Sensitised Tissue Mix (Hot Moist Climate)

Water: 100oz
 Bichromate of ammonia: 1oz
 Bichromate of potash: 1oz
 Carbonate of soda: 100gr
 Strong ammonia: 2 dr

A4.4.39 Sensitised Tissue Mix (Carbon prints with vignettes)

Bichromate of Potash: 8oz
 Water: 120oz
 Strong Ammonia: 3 oz
 Accelorine: 1oz

A4.4.40 Tissue Mix

Gelatine (Medium): 100oz to 130oz
 Sugar: 20oz
 Soap: 5oz
 Colouring Matter: 3 to 6oz
 Water: 400cm³

A4.4.41 Tissue Mix

Water Distilled: 25oz

Gelatine (Nelsons No1): 400 grains or

Gelatine (Nelsons amber): 3000 grains

Soap (pure white): 200 grains

Sugar: 1-2 oz

Sensitiser

Bichromate of potash: 300gr

Carbonate of soda (crystalised): 50 – 150 grains

A4.4.42 German Method

Gelatine (Nelsons No1): 75 parts

Gelatine (Hard): 25 parts

Pure White Soap: 5 parts

Rock Candy: 25 parts

Water (Distilled): 300 parts

Colour Matter: 3-5 parts

Note

In dry conditions add Glycerine instead of Soap

Glycerine: 5pts

Use within 3-6 days summer

6-10 days in winter

Sensitiser

Water: 50pt

Bichromate of Potash: 5pt

Carbonate of Soda: 70gr

A4.4.43 The American Carbon Manual

Carbon Printing in the solar camera

A4.4.44 Tissue

Distilled water: 90g

Pure gelatine: 10g

Bichromate of ammonia: 1.25

Liquid Indian-ink: 15g

A4.4.45 Swans

Gelatin: 2pt

Water: 8pt

Sugar: 1pt

Colour: As required

Additives: gum arabic, albumen, dextrin

Sensitiser

Bichromate of Ammonia, Bichromate of Potash. 1:10 tissue mix

Note

Apply ox-gall to the surface of the glass (Brush, or immersion),

A4.4.46 Liesegang's Manual of Carbon Printing

Dr Liesegang Translated by R Marston

Tissue Mix

Water: 1 oz / 440pt

Gelatine: 120-150gr / 120-150 pt

Soap: 1oz / 15 pt

Sugar: 21oz / 21pt

Dry Colouring Matter: 4 to 8oz / 4-8 pt

Sensitiser

Potassium dichromate: 1oz / 1 part

Water: 20oz / 20 parts

A4.4.47 Photographic Reproduction Processes.

A practical treatise of the photo-impressions without silver salts for the use of photographers, architects, engineers, draughtsmen, and wood and metal engravers,

Tissue Mix

Gelatine: 110 pt

Sugar 25: pt

Soap dry: 12 pt

Water: 350 pt

Sensitiser

2-5%

Water: 1,000 pt

Potassium bichromate: 30pt

Aqueous ammonia: 2 pt

A4.5 Collodion Recipes**A4.5.1 Correspondence – Carbon Printing - Special Correspondent**

Photographic News 261 June 1st 1866

Collodion Recipe

Ether: 62° 100g

Alcohol - 40° - 100g

Gun Cotton: 5g

A4.5.2 A new treatise on the modern methods of carbon printing

(Second Edition) A.A. Marton 1905

A4.5.3 Collodion Recipe

Amyl Acetate: 1 oz

Colombian spirit: 2oz

Ether: 1oz

Gun Cotton: 48 gr

A4.5.4 Collodion Recipe

Ether 15oz

Alcohol 14oz

Gun Cotton 1oz

A4.5.5 The American Carbon Manual

Carbon Printing in the solar camera

Collodion

Ether: 150g

Alcohol: 80g

Gun Cotton: 6 g

A4.6 Varnish Recipes**A4.6.1 Woodburytype**

From Photographic News Sept 14th 1883

A4.6.2 Paper Varnish

Borax 4 oz

Sodium Carbonate 1 oz

Water 3 pts

Bring to boil and add

White Shellac 1lb

A4.6.3 Final Print Varnish

Borax 4 oz

Water 3 pints

Shellac 8 oz

A4.7 Substrate Key**A4.7.1 A new treatise on the modern methods of carbon printing**

(Second Edition) A.A. Marton 190

A4.7.2 Substrate Preparation - Transfer Paper

Gelatine (Hard): 1oz

Water: 16oz

Chrome Alum: 30 gr

A4.7.3 Substrate Preparation - Transfer Glass

Gelatine (Hard): 30gr

Water: 32oz

Chrome Alum: 50gr

4.8 Production Issues

4.8.1 Wash support adhesive tests

I tried several methods including Copydex latex glue, Elmers gum and a self adhesive photographic mount. The copydex and elmers glue worked well however it was difficult to spread it so that it was even and flat. The self adhesive photomount was not strong enough to hold the tissue in place. There are other high contact double sided vinyl adhesives used in industrial signmaking and largeformat printing and laminating available that would give an instant bond however solvents would be required to remove the tissue from the support. This line of investigation was not pursued as removing the tissue from the support would cause damage to the freshly developed photo relief.

4.8.2 Surface Key for substrate

It was observed that rubbing the gelatine on did not produce good results. I found that the use of coating rods was more suitable for producing carbon tissue and was a bit messy in producing multiple sheets of paper for Woodburytype Printing. Good results were obtained by floating the paper across gelatine. When floating the paper across the gelatine one technique that has advantages was to use a large glass dish that was raised slightly above a mirror. This allowed me to view the underside of the page through the glass bottom of the dish without continually lifting the paper and risking getting bubbles on the surface. This method however needs an area for the paper to drip dry. It also has the potential to curl more. The most practical method that I found was brushing it on with a foam applicator brush. This reduced waste and mess. I stretched the paper onto a large sheet of plate glass. When dried I was able to shellac or varnish the surface of the paper. When dried for a second time I used a weaker solution of gelatine for the sizing of the paper and gave two - three weaker coats of gelatine rather than one heavy coat. Chrome Alum could then be brushed on to tan the surface. When removed from the glass sheet the glass had dried to a smoother and flatter than other methods. The main disadvantage to this method is that you are limited to how many sheets you can do on the glass backing at a time. I worked in over size sheets A2 in size which could then be trimmed back for use. I also found that this method reduced the need for calendering. Bristol Board worked very well for this method.

A5 Appendix for Chapter 5

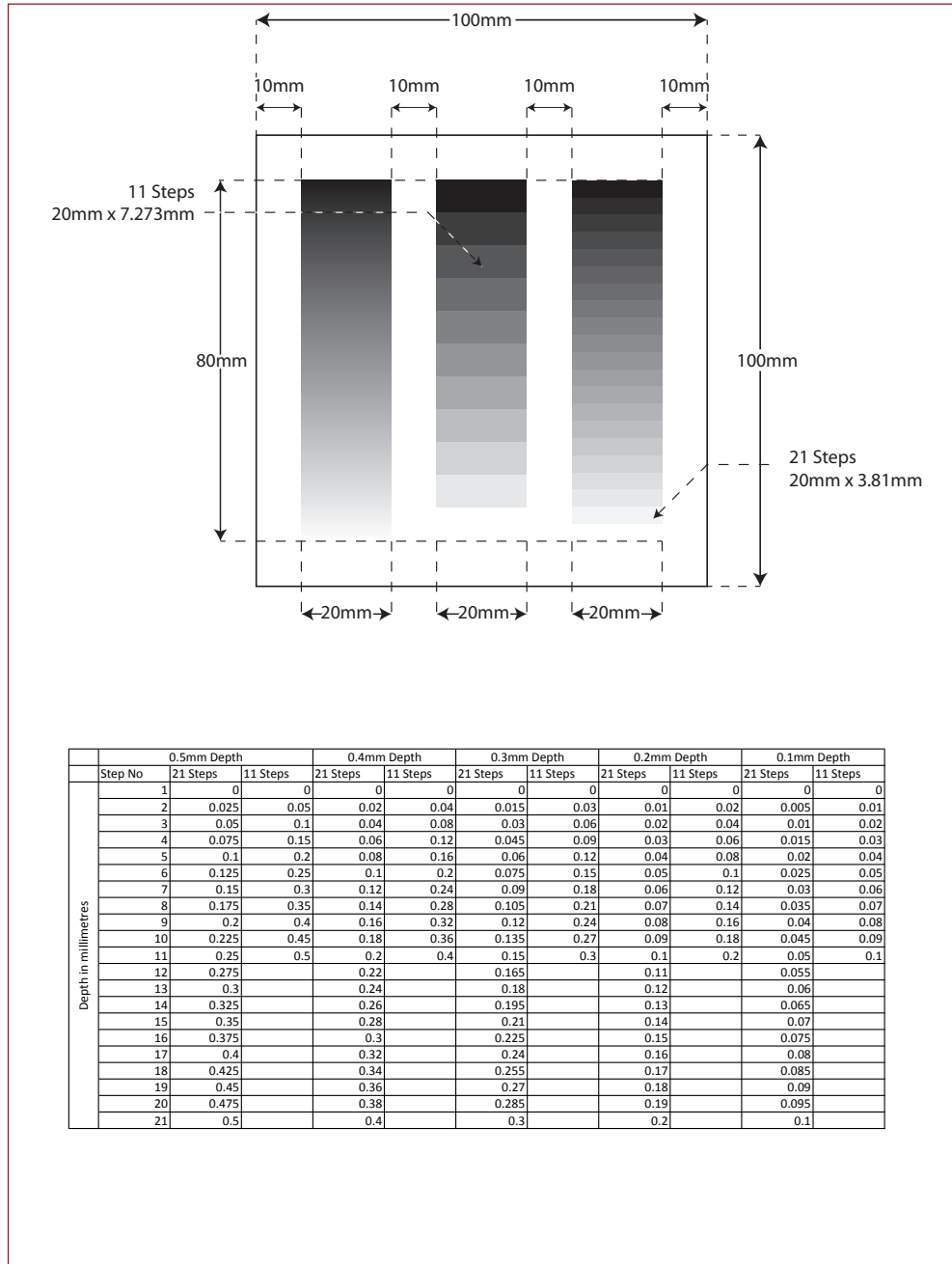

Figure A5.1 Details of ink draw down test

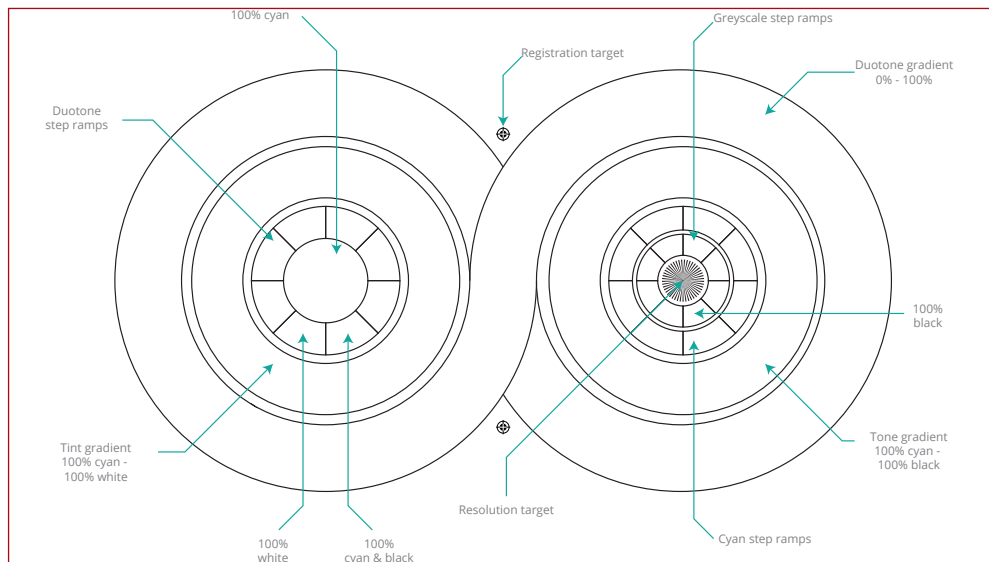
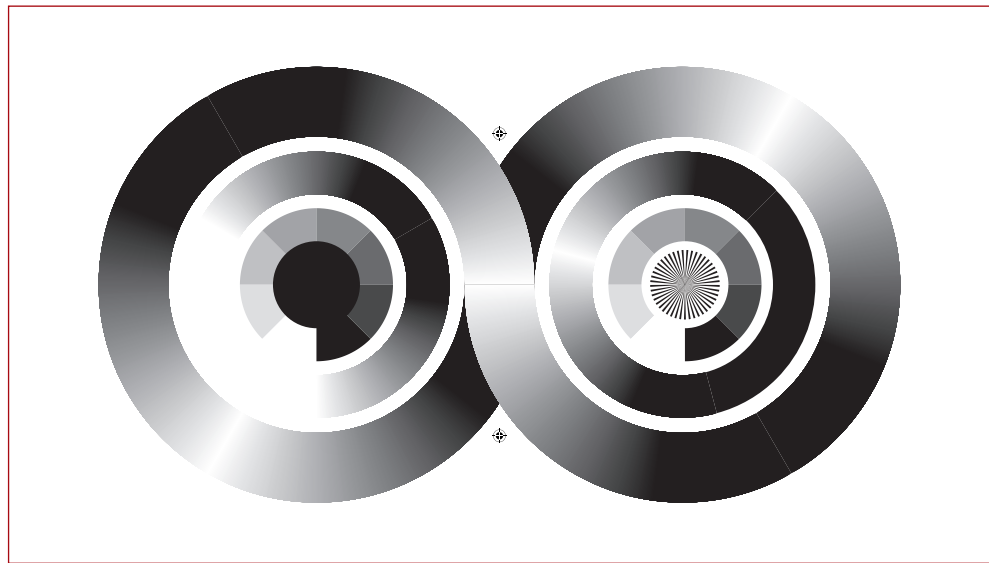

Figure A5.2 Cutting resolution test and tonal ramp

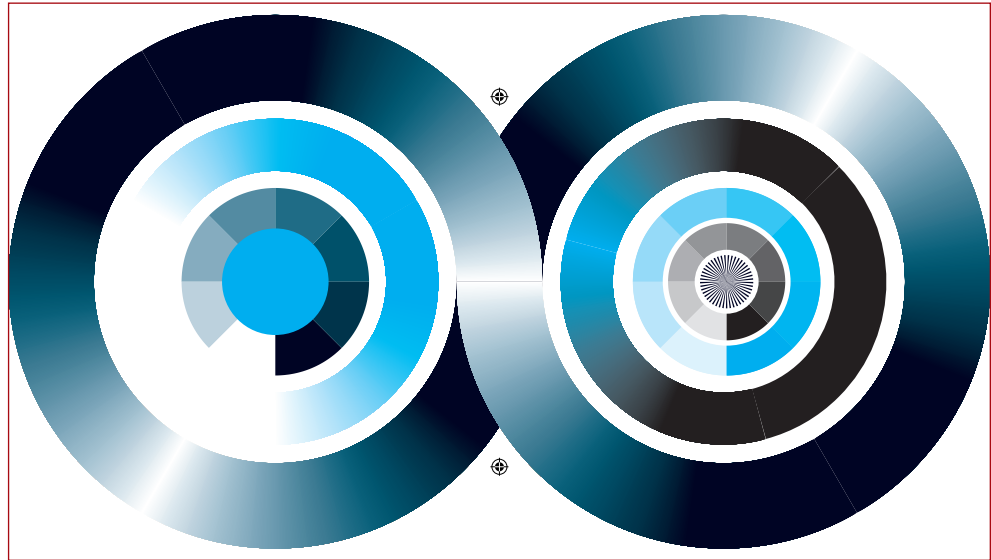

Figure A5.3 circular resolution test



Figure A5.4 circular resolution test



Figure A5.5 circular resolution test mill in material



Figure A5.6 circular photographic test mill in material (iStock.com/ NMaximova)

A6 Appendix for Chapter 6

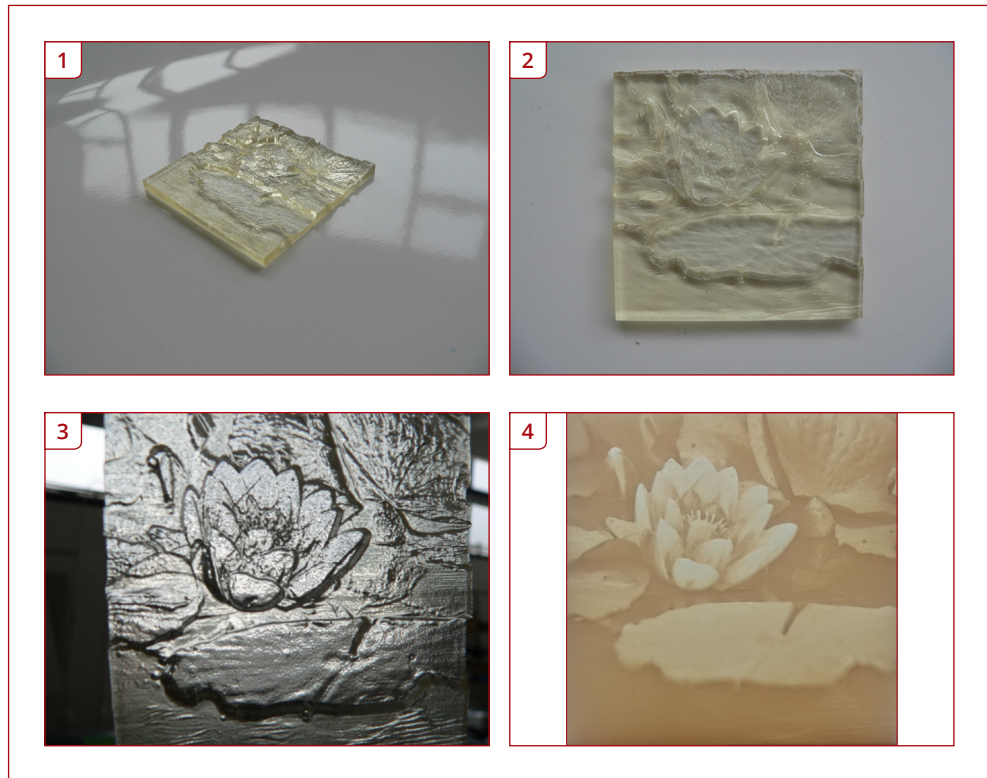

Figure A6.1 3D models generated from colour separations

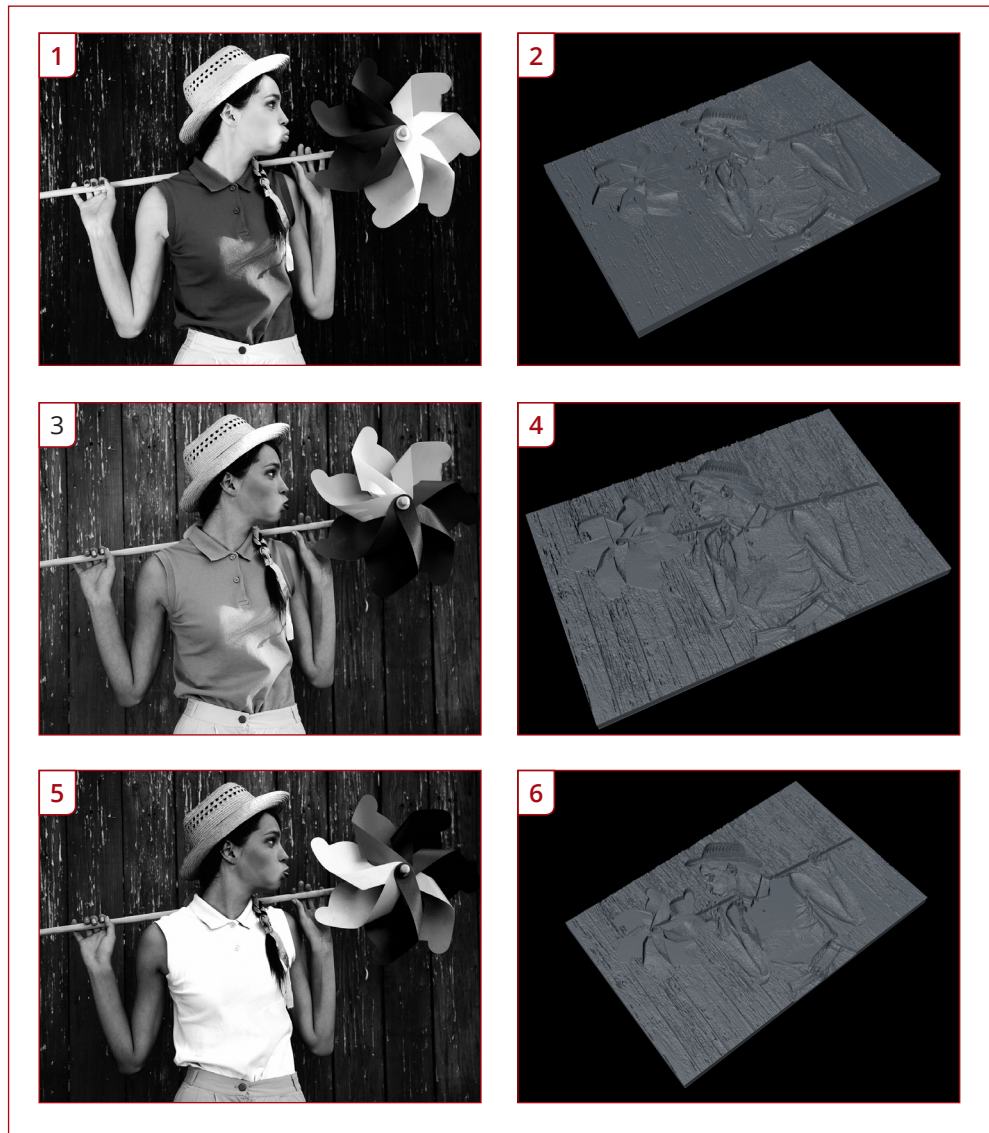

Figure A6.2 3D models generated from colour separations

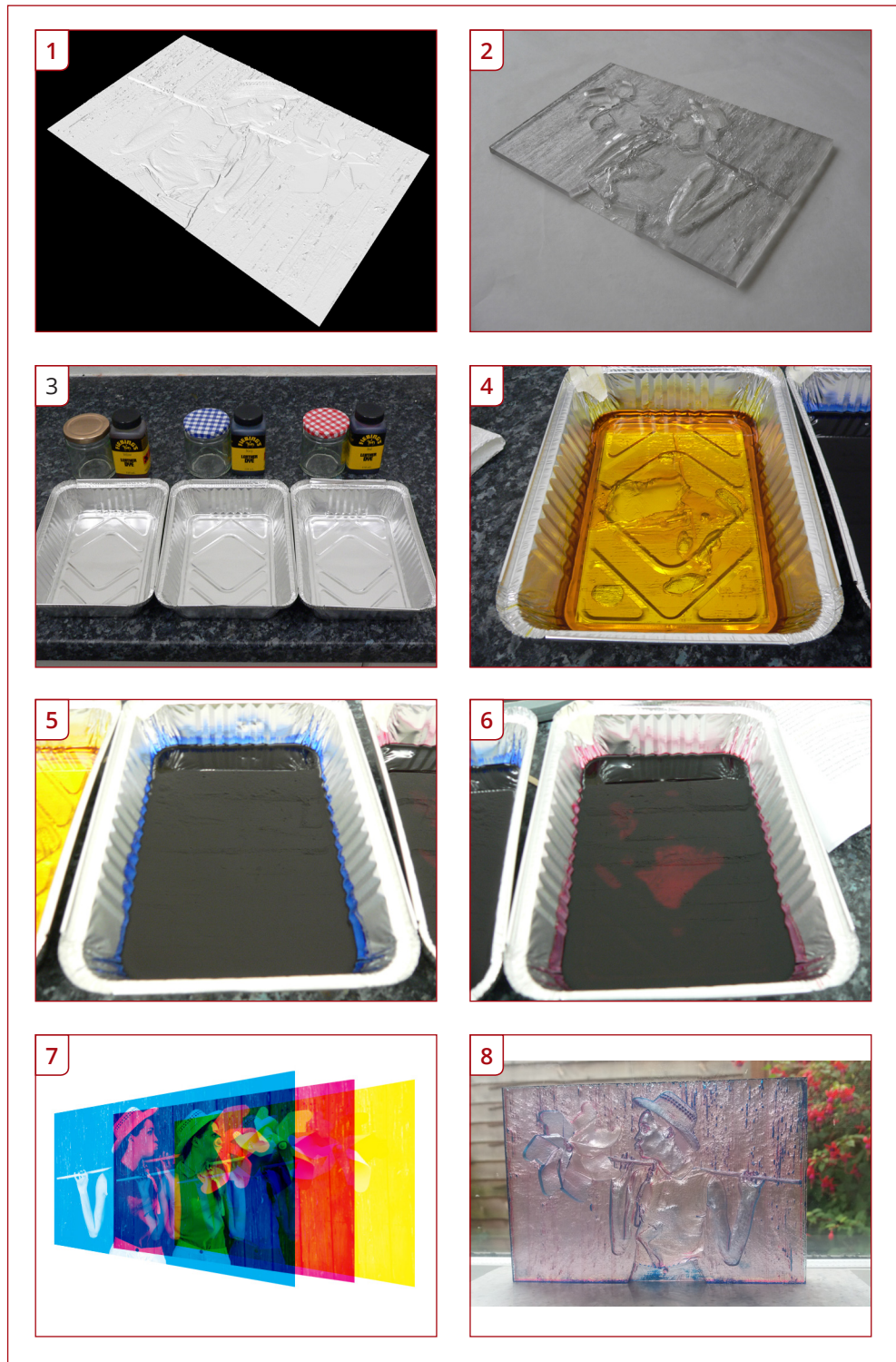

Figure A6.3 3D printed lithophanes in clear polyjet material dyed with aniline pigments

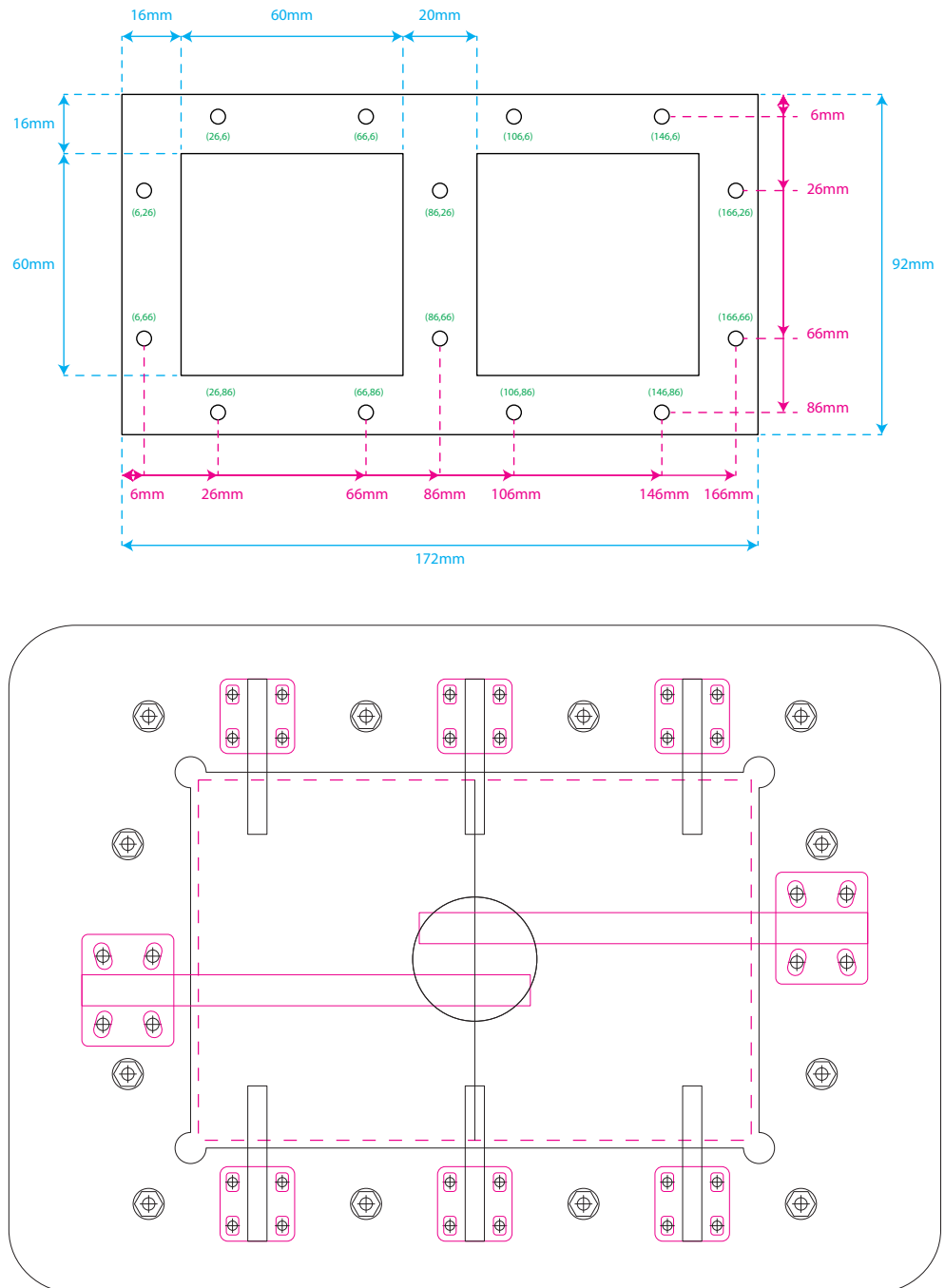

Figure A6.4 Technical details of printing jig.

A6.1 Registration systems

Traditional WBTS prints did not need to develop a registration system as the process remained monochromatic. The difficulty with registration is that each colour separation layer is added on top of the previous one. In traditional Woodburytype printing as gelatine was used in two stages registration was problematic. Experiences gained testing the traditional WBT method I will say that this was probably down to two factors. Firstly the gelatine that was used to create the photo-matrix could distort slightly as it dried. If it was dried too quickly or too slowly the image would warp. I observed that this can occur very easily. In most instances the even the slightest distortion was enough that it would make registration impossible. The second factor was the depth described for a WBT plate was shallow. Klimaszewski stated in his findings of creating digital WBTs that the deeper the relief the easier it is to print. I have found the same and can concur on this point. It would have been extremely difficult to generate a matrix that could take into account the relief of the the previous layers and remain useable within a registration system.

A6.2 Problems with initial bolt systems registration.

Initial testing with silicone allowed for the printing plates to be closed and bolted together. It was observed that multiple bolt holes around the edge of the printing plates resulted in a larger surface area for the excess silicone to be forced over. The bolt holes acted in some respects as impromptu drainage channels. As the liquid silicone would take the path of least resistance generally every bolt hole would become filled with silicone and the bolt washers and threads would be encapsulated. While pressure could be maintained while the silicone cured it took a considerable amount of preparatory work to clean the threads, wingnuts and bolts for the next use. It was also found that in small print tests such as the waterlily, portrait and test ramps it became excessively messy to perform the printing and uncured silicone tended to overspill onto the workstations and surrounding area. The volume of silicone needed to make the print could be calculated but an excess amount always needed to be made to allow for residual silicone remaining in the mixing vessels and to allow enough silicone to be deposited on the plate avoiding air bubbles and pockets of no surface contact with the plate. While the initial tests that involved c clamps were successful they were impractical as they needed a large surface area if multiple prints were to be produced in one session. The second iteration of bolting plates together reduced the need for surface area in printing as the plates were mobile enough to put in a curing area and for additional work to be undertaken, however the clean up time was long and moving printing plates that oozed excess silicone was very messy.

A solution was needed that could be portable, maintain pressure and be easy to clean between print set ups.

A portable printing press was designed and assembled from 10mm and 5mm acrylic. The parts were laser cut and apertures produced to create a pocketed platen and bold assembly holes. The holes were then threaded so the small printing press could be easily assembled (and disassembled for cleaning should the need arise). 6 quick release toggle clamps that could clamp to a pressure of 16kg evenly spaced around the outer edges of the printing platen. A cavity was in the central pocket to allow for easy removal of the printing plate should silicone adhere the plate to the surface.

The margins were removed where the image would stop 2mm from the edge of the printing plate reducing the need for drainage channels. The images were designed to have a rounded edge to enable corner pin registration by simply dropping in the shank of a bolt to keep the corners square while the clamps were closed and the excess silicone removed.

The initial test where successful however upon removal from the printing press a halo effect could be noticed in the centre of the image. The clamps at the edge of the image were unable to expel the silicone and as a result trapped it in a central pocket. This resulted in the centre of the image having a shadowlike circle in the middle. A second iteration of the printing press was designed where the position of the clamps were slightly adjusted and two long arm clamps with a clamp pressure of 24kgs were added allowing for pressure to be placed centrally. In the new set up the centre clamps were closed first and a short time period was allowed for some of the silicone to be expelled. Then working around the press the additional clamps were closed. The improved printing press allowed for more even pressure to be applied while maintaining accessibility to the platen. Clean-up time was also greatly reduced to a matter of minutes.

The initial registration system for digital photoplastographic systems was based on BS 11084-2:2006 which covers the pin registration system for printing plates and print technology. This is a tried and tested industry standard for registering large sheets for multiple separation prints. The issue lies in that that system that produces the registration holes and pins is too large to be used on prints that are 6x4 inches in size. A novel approach was taken in looking into alternative standardised systems capable of producing a punched registration hole. Looking at office based systems standards 5097-1:1974, 5641:1892, 1467:1972 and 4448:1988 all involve the use of the hole perforator for the storage of loose leaf pages in a D ring binder. There is a variance in the tolerances in which the perforators are manufactured and manufacturers specifications also have variation that will cause inconsistencies between identically produced perforators.

A typical office perforator was used to punch a pair of holes into a sheet of black

100gsm paper and the paper was scanned on a 1:1 scale. The exact dimensions of the holes were taken and transferred into the design for the printing plates. The plates would be cast and the holes would become the pins for the substrate to register to.

The system worked in terms of allowing registration however the time taken to load a sheet of paper was often too long and the gelatine ink set on the plate or it was partially set by the time the tympan was applied and pressure was added. Even when the paper was locked in place in time the hasty set up often caused air bubbles to become trapped between the ink and the paper spoiling the plate.

In the attempts to register the print substrate it became very apparent that the coated and varnished paper physically could not cope with the added moisture of the gelatine layers. The prints would suffer from severe cockling making the registration of the next plate impossible. When the prints were left in between separations as the gelatine dried it would contract and curl the page making the registration impossible also. The substrate would need to be reviewed and accessed.

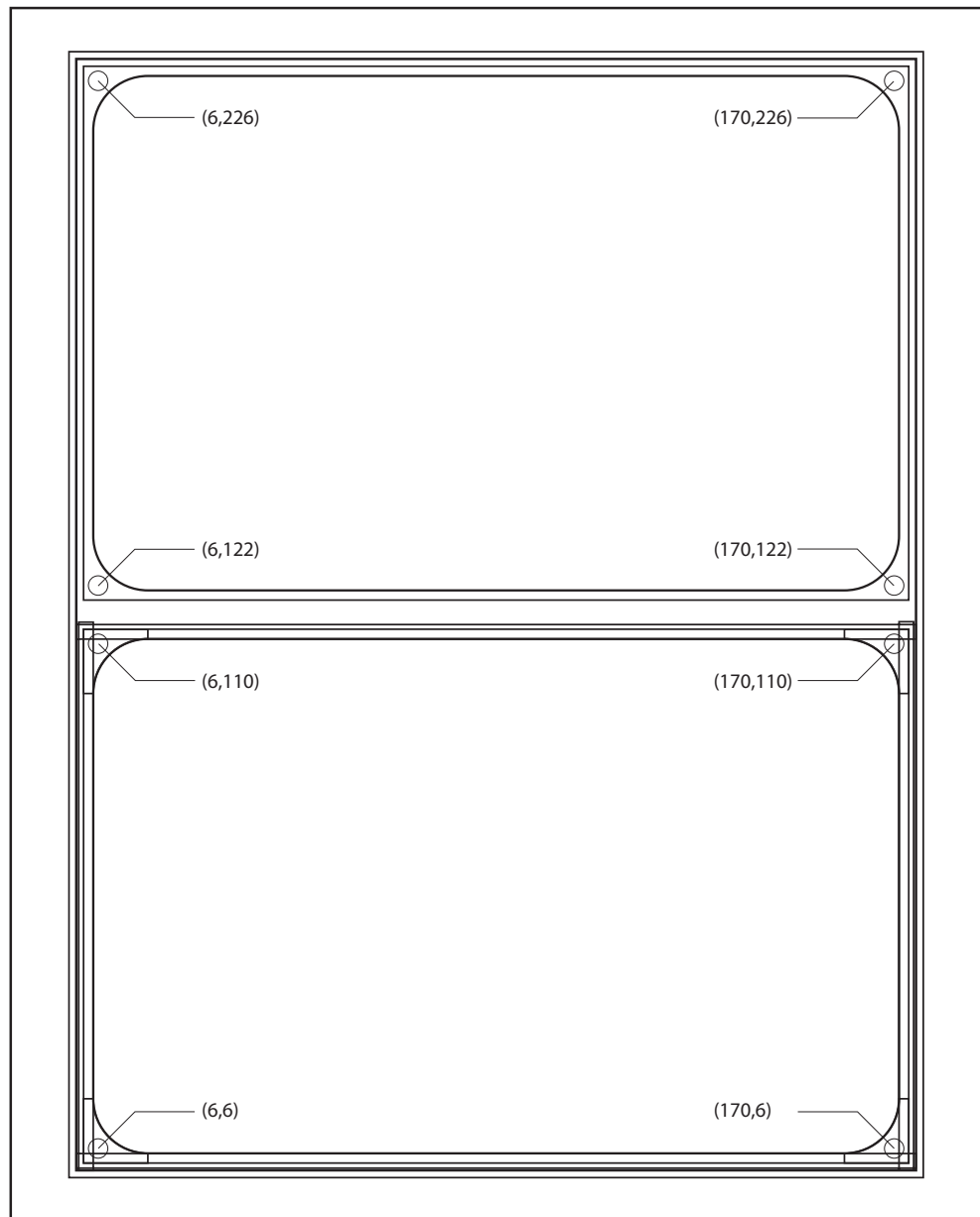

Figure A6.5 Technical details of CNC milled plates

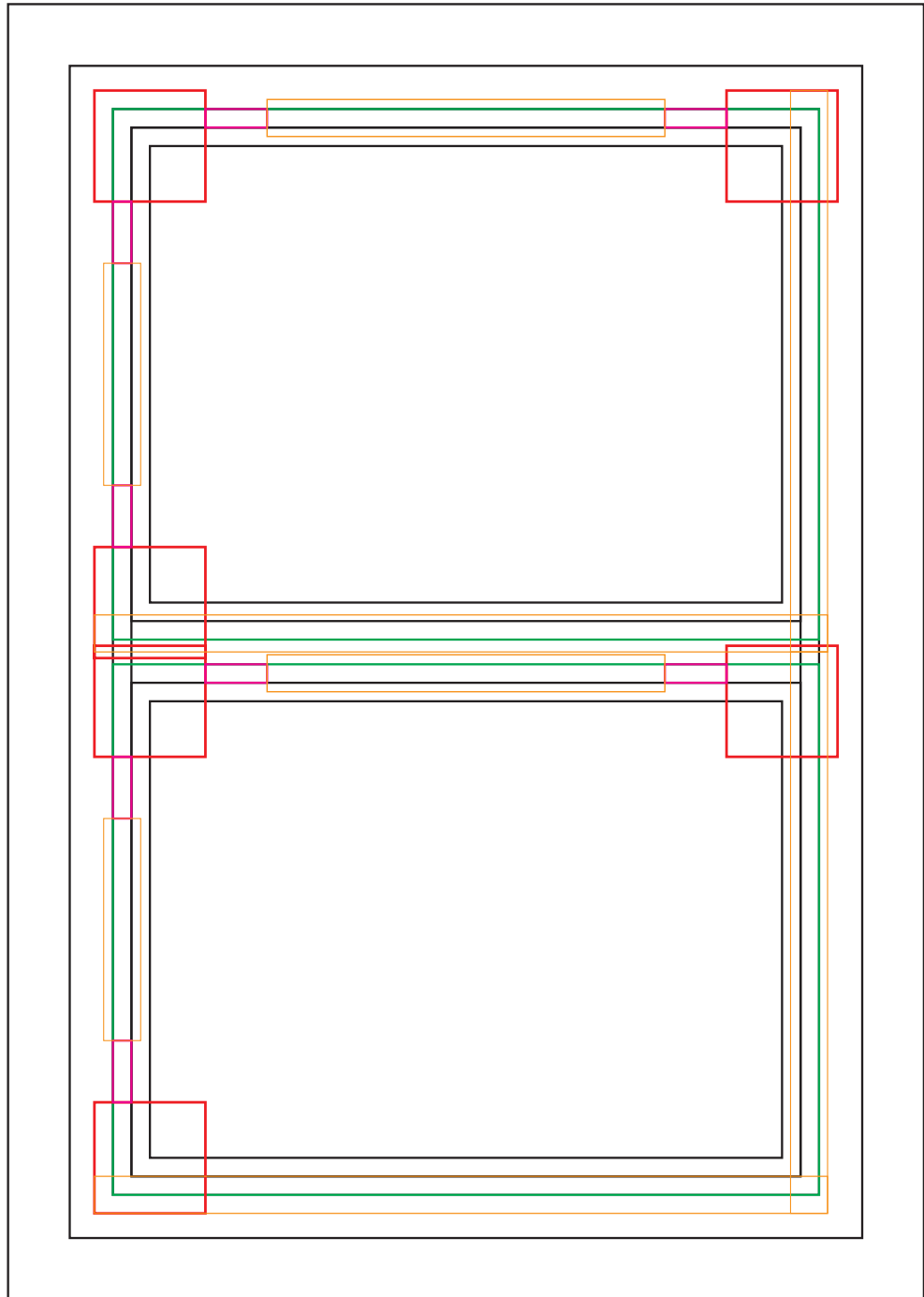

Figure A6.6 Example of pocketing tool paths for CNC plate.

Simplified Breakdown of Steps for 3 Colour Silicone Swatch Print

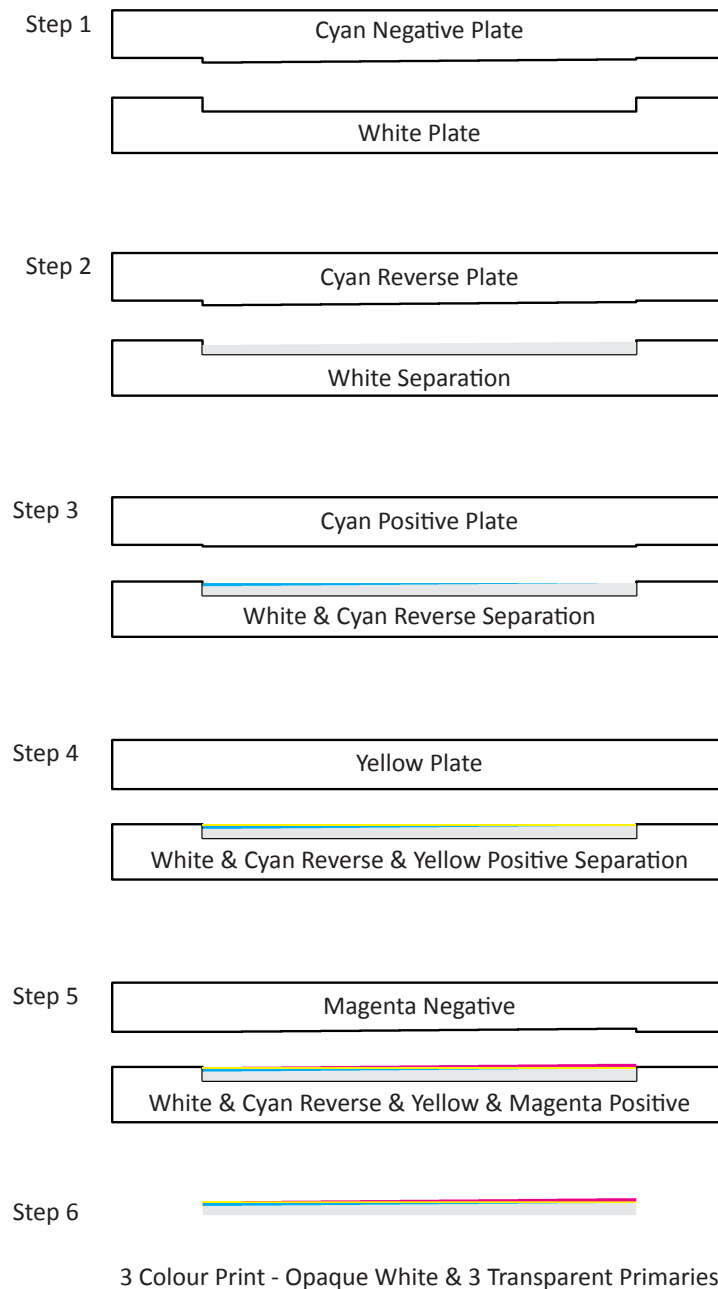
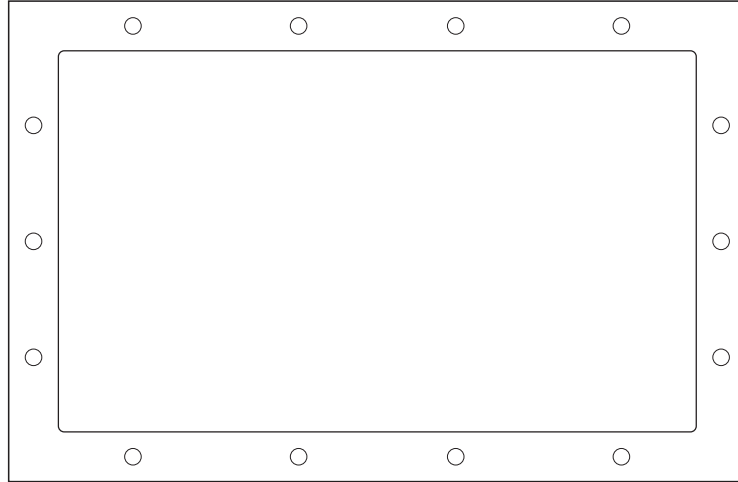

Figure A6.7 Breakdown of 3 colour printing with silicone

3 Colour Silicone Swatch Separation Plates

White Plate



Cyan Plate

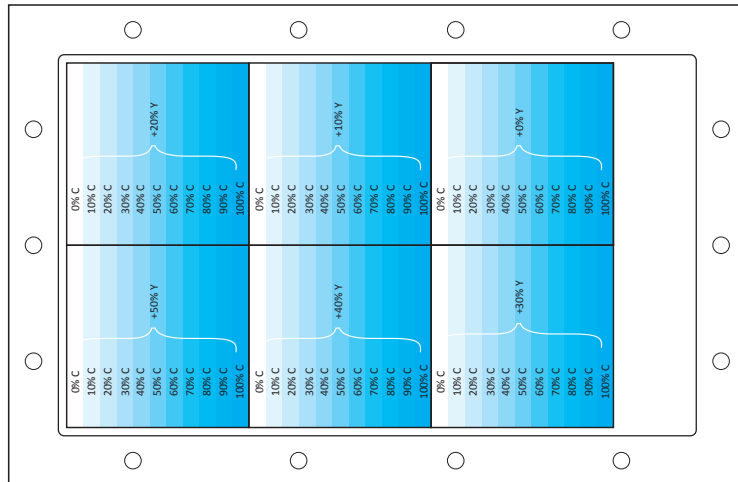

Yellow Plate

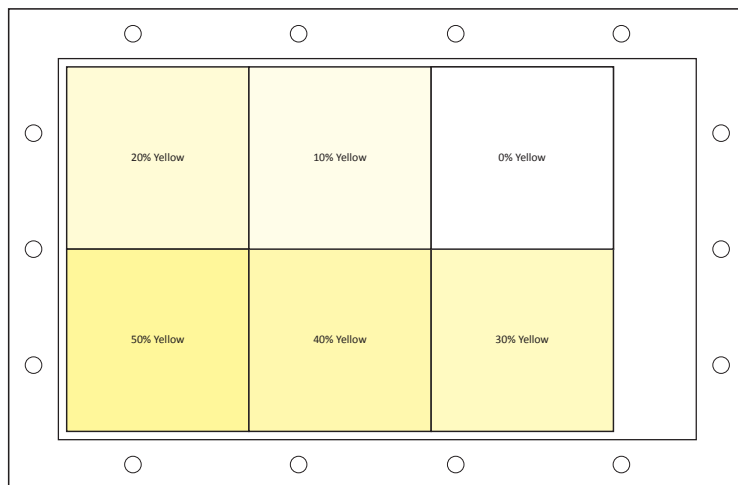

3 Colour Silicone Swatch Separation Plates

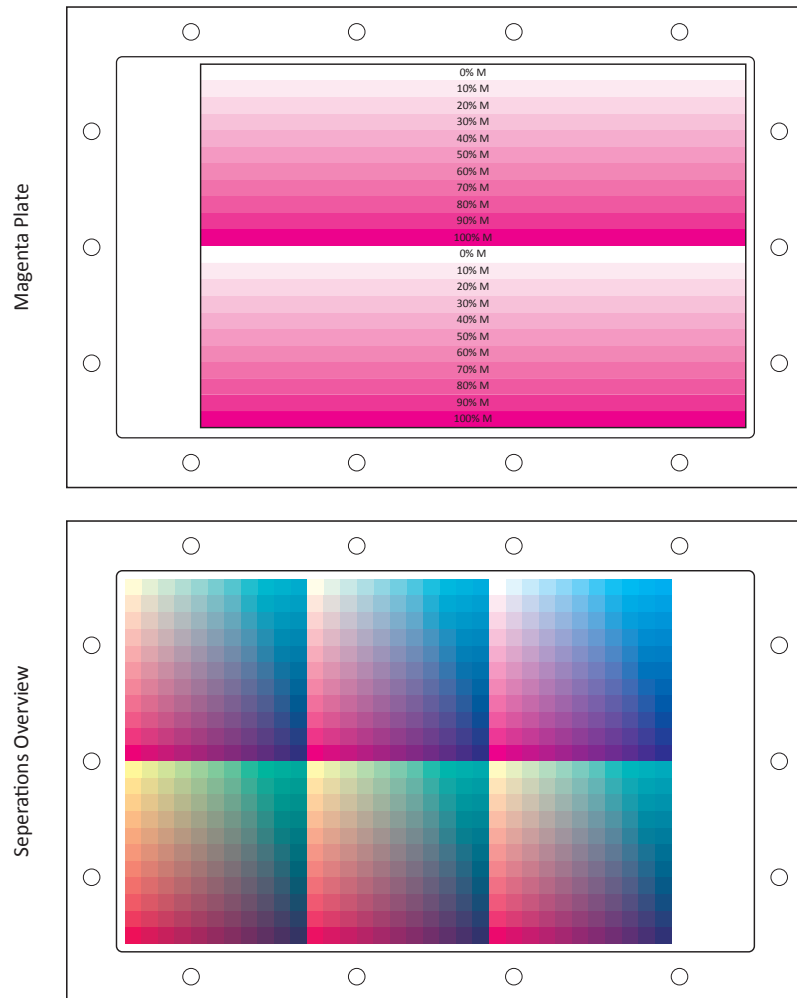

Figure A6.8 (Previous page) Technical breakdown of 3 colour swatch test printed in silicone.

Figure A6.9 Technical breakdown of 3 colour swatch test printed in silicone.

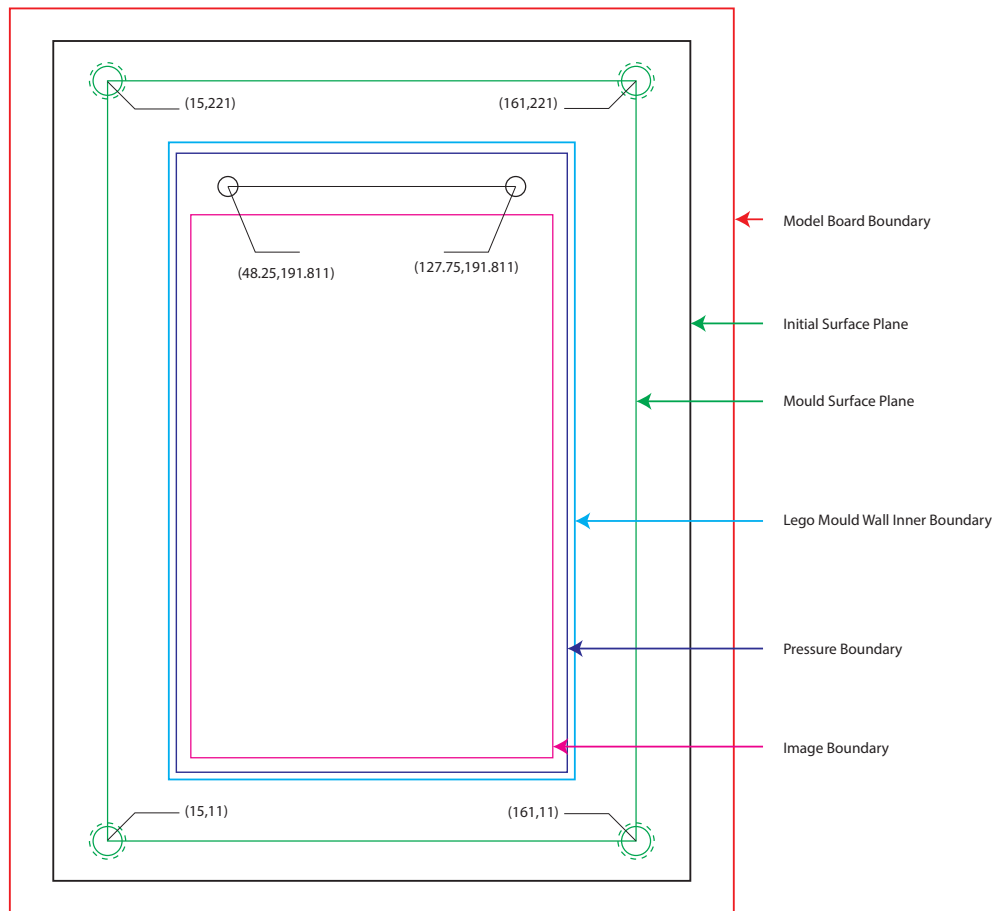

Figure A6.10 CNC tool paths for registration silicone plates

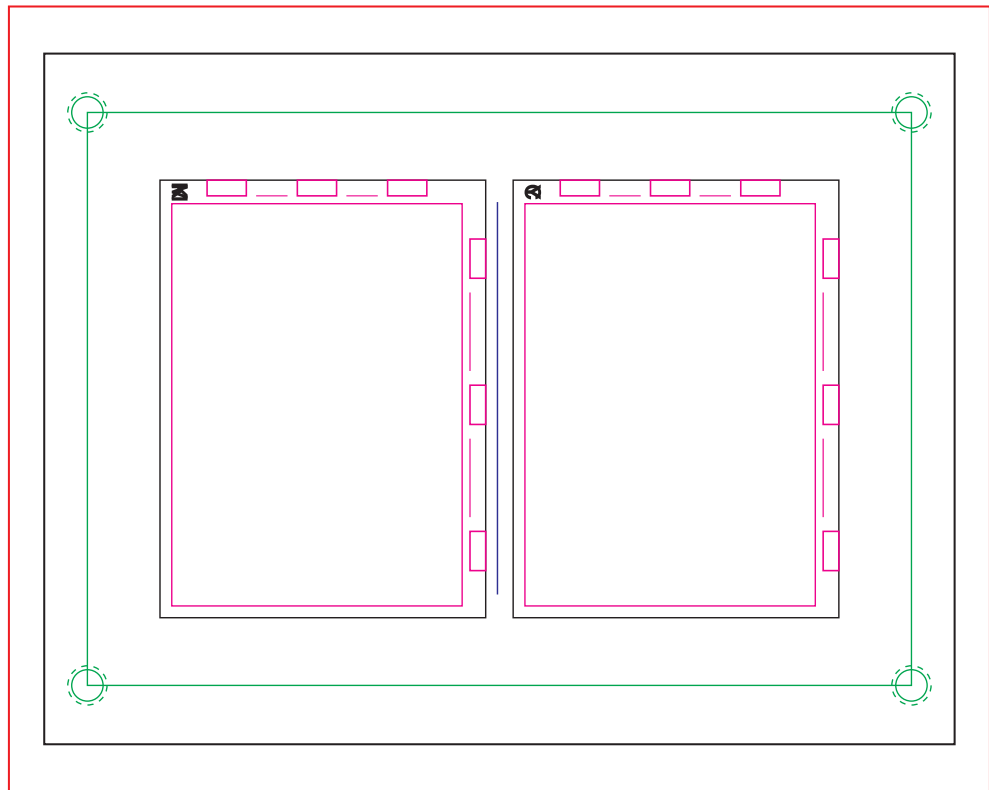

Figure A6.11 CNC tool paths for silicone registration plates with stop fence

A6.3 CNC Milled substrated

Below is a list of substrates used in the CNC milling process

A6.3.1 Model Boards

Necuron 160
Necuron 301
Necuron 480
Necuron 540
Necuron 600
Necuron 620
Necuron 651
Necuron 702
Necuron 770
Necuron 840
Necuron 1001
Necuron 1007
Necuron 1007
Necuron 1020
Necuron 1050
Necuron 1300

A6.3.2 Eurethanes

Easyflo Clear Polyeurethante
Easyflo 95 Polyeurethante
Easyflo 120 Polyeurethante
Easyflo SG2000 Polyeurethane
Easyflo FC6000 Polyeurethante
60D Polyeurethene
40D Polyeurethane

A6.3.3 Acrylic & Mineral Composite

Dupont Corian

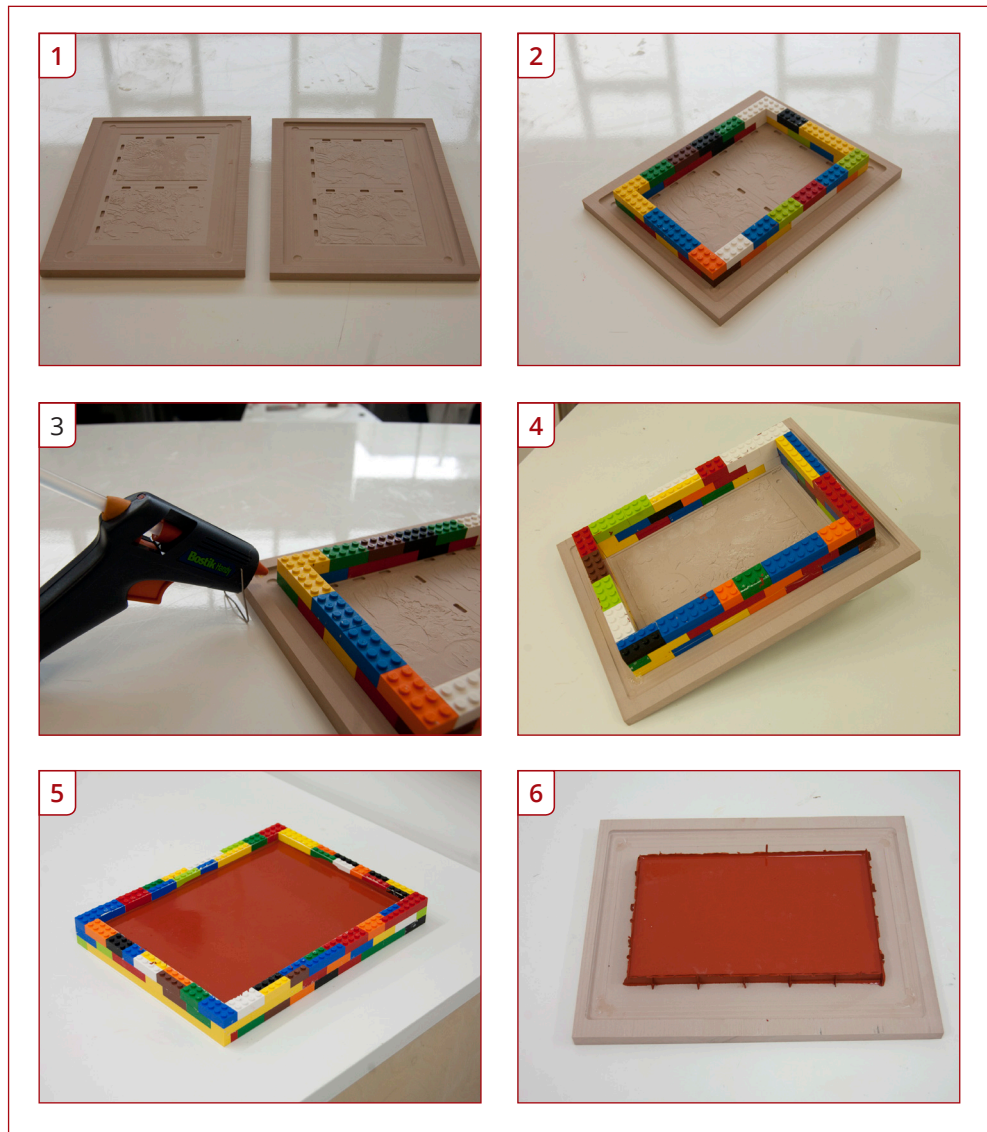

Figure A6.12 Plate casting process

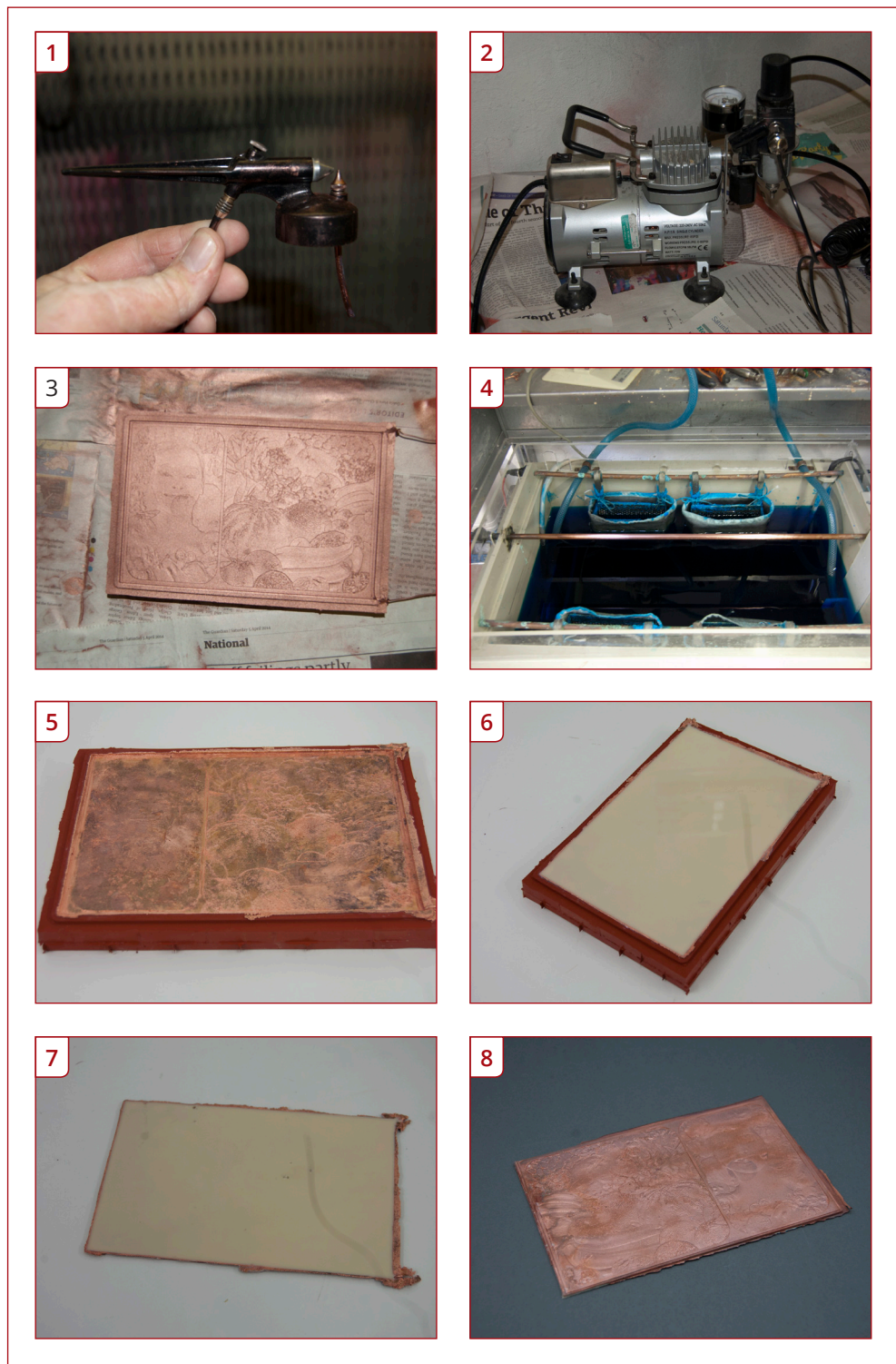

Figure A6.13 Electroforming of silicone plates

B Bibliography

ANON. (2011) 3D Printing a Car. Yes, a Car. *Automotive Design & Production* [online]. 123 (6), pp.22-22.

ANON. (2007) What color is color? *Vision Systems Design* [online]. 12 (6), pp.70-71.

BRITISH Standards. Available from: www.bsigroup.com [Accessed 04/05/2015].

COLOUR Printing 7.0: Next Generation Multi-Channel Printing (CP7.0). Available from: <http://cp70.org> [Accessed 04/05/2015].

THE Health and Safety Executive. Available from: <http://www.hse.gov.uk> [Accessed 04/05/2015].

INTEGRATING Lenticular into Digital Printmaking. Available from: <http://dl.acm.org/citation.cfm?id=1242215> [Accessed 11/7/2012].

JIMMY Carter 1976 Speech. Available from: <http://www.americanrhetoric.com/speeches/jimmycarter1976dnc.htm> [Accessed 04/05/2015].

MHIC Reachtain. Available from: <http://www.mhicreachtain.com> [Accessed 04/05/2015].

MYERS & Briggs. Available from: <http://www.myersbriggs.org> [Accessed 04/05/2015].

ANON. Open Design Now | Why Design Cannot Remain Exclusive [online]. <http://opendesignnow.org/> ed. BIS Publishers B.V. (1 April 2011). [Accessed 11/8/2012].

THE Singapore Statement. Available from: <http://www.singaporestatement.org> [Accessed 04/05/2015].

THE UK Research Integrity Office. Available from: <http://www.ukrio.org> [Accessed 04/05/2015].

A.H. (03/08/1894) Extract - Some Remarks on Process Illustration for the Unlearned. *Amateur Photographer*. XX .

ABNEY, W.D.W. (1896) Affiliation of Photographic Societies. Six Lectures on "Photography with the Bichromate Salts" i) Scientific and Historical Preliminary. *The Photographic Journal*. May 29 (36), pp.254-259.

ABRIL, P. and Plant, R. (2007) The patent holder's dilemma: buy, sell, or troll? *Communications of the ACM* [online]. 50 (1), pp.36-44.

ACTIVE State Komodoedit. Available from: <http://komodoide.com/komodo-edit/> [Accessed 04/05/2015].

ADAMS, A. (1983) *The Print. the New Ansel Adams Photography Series / Book 3*. 1st ed. USA: Little, Brown and Company.

- ADAMS, A. (1981) *The Negative*. the New Ansel Adams Photography Series / Book 2. 1st ed. USA: Little, Brown and Company.
- ADAMS, A. (1980) *The Camera*. the New Ansel Adams Photography Series / Book 1. 1st ed. USA: Little, Brown and Company, Ltd.
- ALABASTER, J.H. (10/02/1893) *Photography in Relation to the Art of Printing*. Amateur Photographer. XVII .
- ALLRED Redman, J. (2006) *Enlarger*. In: Warren, L., ed. (2006) *Encyclopedia of Twentieth-Century Photography Volumes I-III*. Routledge, pp.443-444.
- ANDERSEN, B. (2003) *The neglected patent controversies in the twenty first century*. *Revista Brasileira De Inovação* [online]. 2 (1), pp.35-78.
- ANON. (1889) *The Cabinet Portrait Galler*. *Dorkig Advisor*. September 28.
- ANON. (1885) *The Late Mr. W. B. Woodbury*. *Manchester Courier and Lancashire General Advertiser*. Tuesday 15 September , 7.
- ANON. (1885) *Literary and art gossip*. *The Leeds Mercury*. Monday September 28 , 3.
- ANON. (1885) *Sudden death of Mr. Walter Woodbury*. *Manchester Courier and Lancashire General Advertiser*. Tuesday September 08 , 6.
- ANON. (1879) *Scientific Notes*. *The Graphic*. May 31 , 530.
- ANONYMOUS (2009) *INTELLECTUARY PROPERTY: Copycat trap*. *Design Week* [online]. 24 (32), pp.17.
- ANONYMOUS. (1890) *Photographs in Colour*. *The Blackburn Standard and Weekly Express*. Saturday September 6 , 3.
- ANONYMOUS (1887) *The Home of the Photogravure, A Visit to Messrs. Boussod, Valadon, and Co. At Ansieres. - How Photographs of Pictures are Multiplied*. *Pall Mall Gazette*. (September 29), pp.2.
- ANONYMOUS (1867) *Permanent Printing*. *The Photographic Journal*. (Oct 15), pp.115.
- ANONYMOUS (1866) *Our Presentation Print. - Woodbury's Process*. *Photographic News*. X (January 26), pp.37-38.
- ANONYMOUS (1862) *The International Exhibition of 1862, The Illustrated Catalogue of the Industrial Department. . 1 British Division 1* pp.86.
- ARCE-LOPERA, C., Masuda, T., Kimura, A., Wada, Y. and Okajima, K. (2012) *Luminance distribution modifies the perceived freshness of strawberries. I-Perception*. 3 pp.338-355.
- ARCHER, B. (1995) *The Nature of Design. Co-Design*. *Interdisciplinary Journal of Design*. (January), pp.6-13.

- ARMITAGE, J. (1999) From Modernism to Hypermodernism and Beyond, An Interview with Paul Virilio. *Theory, Culture & Society*. Vol. 16 ((5-6)), pp.25-55.
- ASAKAI, T. and Hioki, A. (2015) Reliability in standardization of sodium thiosulfate with potassium dichromate. *Microchemical Journal*. 123 (November), pp.9-14.
- STANDARD Terminology for Additive Manufacturing Technologies F2792 – 12a. (2013) United States: ARTSM.
- ATKINSON, A. (2005) The Creation of Digital Photographic Fine Art Print through the Woodburytype Model. University of the West of England.
- ATKINSON, A. (2003) Continuous Tone Alternatives To Halftone Through Historical Reflection. PICS 2003: Image Processing, Image Quality, Image Capture Systems Conference, Including MCS/05 Fifth International Symposium on Multispectral Color Science. 2003 (May 13,), pp.p. 285-290;
- BADEN Pritchard, H. (1869) A visit to Asnières. *The Photographic Journal*. 13 (September 15), pp.151-153.
- BAQAI, F.A., Lee, J., Ufuk Agar, A. and Allebach, J.P. (2005) Digital Color Halftoning. Problems, algorithms, and recent trends. *IEEE Signal Processing Magazine*. (January), pp.87.
- BARE Bones Software Available from: <http://www.barebones.com/products/bbedit/> [Accessed 04/05/2015].
- BARE Bones Software Text Wrangler. Available from: <http://www.barebones.com/products/textwrangler/> [Accessed 04/05/2015].
- BARRET, O. (2007) A History of the Woodburytype. 1st ed. Nevada City, California: Carl Mautz publishing.
- BARTEN, P.G.J. (1999) Contrast Sensitivity of the Human Eye and its Effects on Image Quality. 1st ed. HV Press.
- BASIL, M. (2011) Use of photography and video in observational research. *Qualitative Market Research; an International Journal*. 14 (3), pp.246-257.
- BEDFORD, W. (1884) Monthly Technical Meeting, Tuesday April 22 1884. *The Photographic Journal*. 25 (April 25), pp.104-107.
- BENEDICT (15 August 2016) Autodesk Offers Grayscale Trick for DLP 3D Printing at Sub-Pixel Resolution. Available from: <http://www.3ders.org/articles/20160815-autodesk-offers-grayscale-trick-for-dlp-3d-printing-at-sub-pixel-resolution.html> [Accessed 02 September 2016].
- BENSON, R.V. *The Printed Picture* [online]. New York : Museum of Modern Art : c2008.

- BENTLY, L., Davis, J. and Ginsburg, J.C. (2010) *Copyright and Piracy: An Interdisciplinary Critique* [online]. Cambridge: Cambridge University Press.
- BERETTA, G.B., Hoarau, E., Kothari, S., Lin, I. and Zeng, J. (2012) Assessing color reproduction tolerances in commercial print workflow. *Color Imaging SPIE 8292*. XVII pp.1-14.
- BIERSTADT, E. (20/08/1875) On Photo-Mechanical Printing (Part 1). *British Journal of Photography*. XXII .
- BIGGAM, C.P. (2012) *The Semantics of Colour. A Historical Approach*. 1st ed. USA: Cambridge University Press.
- BIRD, W.S. (1878) Remarks on Dr.Monckhovens Paper. *The Photographic Journal*. 18 (April 9), pp.69-72.
- BJØRNGÅRD, H. (2007) *The Chiba System : A Non Toxic Alternative to the Dichromate Processes*.
Or the Product Ion of Photographic Prints in Permanent Pigments by Utilising the Sensitivity of the Ferric Salt to the Spectre and Employing the Polymer Izat Ion of Col Loids. Graduate School of Science and Technology, CHIBA UNIVERSITY.
- BLANCHARD, V. (1875) On a Method of Enlarging. *The Photographic Journal*. 16 (April 16), pp.111-113.
- BLOORE, C. (1991) *Photography and Printmaking 1840 - 1860*. University of Reading.
- BLOY, C.H. (1967) *A History of Printing Ink Balls and Rollers 1440-1850*. 1st ed. Great Britain: The Wynkyn De Worde Society.
- BLUEPRINT *Blueprint*. Available from: <http://www.blueprint2013.com/blueprint2013/Home.html> [Accessed 04/05/2015].
- BOLAS, T. (1896) Note as to the Historical Evolution of Photogravure Methods in Intaglio and Relief. *The Photographic Journal*. 36 (May 29), pp.238-241.
- BOLAS, T. (1880) The Reproduction of Negatives in a Reversed Direction, by the Inverse Action of Light on Gelatine Plates. *The Photographic Journal*. 20 (June 18), pp.127-129.
- BOLAS, T. (16/08/1878) Extract - The Application of Photography to the Production of Printing Surfaces and Pictures in Pigment. *Photographic News*. XXII .
- BOLAS, T. (13/09/1889) The Photo-Mechanical Printing Methods as Employed in the Jubilee Year of Photography (Part 2). *British Journal of Photography*. XXXVI .
- BOLAS, T. (06/09/1889) Extrat - The Photo-Mechanical Printing Methods (Part 2). *Photographic News*. XXXIII .
- BOLAS, T. (06/09/1889) The Photo-Mechanical Printing Methods as Employed in the Jubilee year of Photography (Part 1). *British Journal of Photography*.

- BOOTH, A. and Hyland, P., eds. (1996) *Assessing Group Work; History in Higher Education*. Oxford.
- BOTHAMLEY, C.H. (30/12/1887) Extract - Photography in 1887. *British Journal of Photography*. XXXIV .
- BOULDER Nonlinear Systems, (2001) *Image Resolution Vs. Bit-Depth. the Perceptual Trade-Off in a Two Dimensional Image Array*. Report number: White Paper.USA: Boulder Nonlinear systems.
- BRAINARD, D.H., Longère, P., Delahunt, P.B., Freeman, W.T., Kraft, J.M. and Xiao, B. (2006) Bayesian model of human color constancy. *Journal of Vision*. 6 pp.1267-1281.
- BRIDSON, G. and Wakeman, G. (1984) *Printmaking and Picture Printing. A Bibliographical Guide to Artistic and Industrial Techniques in Britain 1750 - 1900*. 1st ed. Oxford, England: Tht Plough Press.
- BRITISH Journal of Photography (1896) Answers to correspondents. *British Journal of Photography*. (October 30), pp.704.
- BRITISH Journal of Photography (1896) Photography with the Bichromated Salts. *British Journal of Photography*. (May 8), pp.204.
- BRITISH Journal of Photography *British Journal of Photography (1854-2005)*. Available from: <http://www.proquest.com/products-services/artarcharc.html> [Accessed 27 May 2016].
- BRITISH Library British Library. Available from: <http://www.bl.uk> [Accessed 27 May 2016].
- BRITISH Library E-Theses Online Service (ETHOS). Available from: <http://ethos.bl.uk/Home.do> [Accessed 27 May 2016].
- BRITISH Library, f. The British Newspaper Archive. Available from: <http://www.britishnewspaperarchive.co.uk> [Accessed 27 May 2016].
- BRITISH Standards (2011) *Sensory analysis — Guidelines for sensory assessment of the colour of products*. Bs Iso 11037:2011.
- BRITISH Standards (2006) *BS ISO 11084-2:2006 Graphic Technology – Register Systems for Photographic Materials, Foils and Paper – Part 2 Register Pin Systems for Plate Making*. BSI.
- LEAD and Lead Alloys — Rolled Lead Sheet for Building Purposes BS EN 12588:2006. (2006) UK: .
- BRITISH Standards (2006) *Safety of machinery — Safety requirements for the design and construction of printing and paper converting machines — Part 2: Printing and varnishing machines including pre-press machinery*. Bs En 1010-2:2006+a1:2010.

BRITISH Standards (2004) Safety of machinery — Safety requirements for the design and construction of printing and paper converting machines — Part 1: Common requirements. Bs En 1010-1:2004+a1:2010.

BRITISH Standards (2004) Safety of machinery — Safety requirements for the design and construction of printing and paper converting machines — Part 4: Bookbinding, paper converting and finishing machines. Bs En 1010-4:2004+a1:2009.

BRITISH Standards (2002) Safety of machinery — Safety requirements for the design and construction of printing and paper converting machines — Part 3: Cutting machines. Bs En 1010-3:2002+a1:2009.

LEAD and Lead Alloys - Rolled Lead Sheet for Building Purposes BS EN 12588:1999. (1999) UK: .

BRITISH Standard Specification for Milled Lead Sheet for Building Purposes BS 1178:1982. (1982) UK: .

BRITISH Standards (1974) BS 5097-1:1974 Specification for Loose Leaf Binders – Part 1: Ring Binders with Metal Mechanisms.

BRITISH Standards (1972) BS 1467:1972 Specification for Folders and Files.

BROOKS, N. (2011) *Advanced Mouldmaking and Casting*. 1st ed. Ramsbury: Crowood.

BROWN, K. and Cooke, C. (2010) *Professional Doctorate Awards in the UK*. UK Council for Graduate Education.

BROWN, A.P. (2005) *Inks for the Fine Art Printmaker: A System and Methodology for the Development, Testing and Manufacture of Oil-Based Printing Inks for the Fine Art Sector*. M.Phil, University of the West of England.

BRUGIAPAGLIA, A. and Destefanis, G. (2009) Sensory evaluation of meat colour using photographs. *Italian Journal of Animal Science*. 8 (2), pp.480-482.

BUCCAFUSCO, C. and Sprigman, C.J. (2011) The Creativity Effect. *The University of Chicago Law Review* [online]. 78 (1), pp.31-52.

BUNTAIN, C., (2012) *Psychophysics and just-Noticeable Difference*. Report number: CMSC828D Report 4. USA: Department of Computer Science, University of Maryland.

BURMAN, M., Gershwin, S.B. and Suyematsu, C. (1998) Hewlett-Packard Uses Operations Research to Improve the Design of a Printer Production Line. *Interfaces* [online]. 28 (1), pp.24-36.

BURTON, P.W.B. (24/06/1887) E. Edward's Photo-Mechanical Works, Brooklyn, New York. *Photographic News*. XXXI .

CAMFIELD and Wills, D. (1985) Walter Bentley Woodbury. *The Photographic Journal: Official Organ of the Royal Photographic Society of Great Britain and the Photographic Alliance*. 125 pp.551-554.

- CAPONIGRO, J.P. (2011) Toning Black & White. *Popular Photography* (19440510). 75 (9), pp.44-46.
- CARPENTER, E. (2011) Social Making. In: Charny, D., ed. (2011) *The Power of Making, the Importance of being Skilled*. London: V&A Publishing and the Crafts Council, pp.48.
- CARTIER-BRESSON, A. (1998) Methods of producing photographic prints. In: Frizot, M., ed. (1998) *The New History of Photography*. Konemann UK Ltd; First English Edition edition (Dec 1998), pp.755-757.
- CATANESE, P. and Geary, A. (2012) *Post-Digital Printmaking. CNC, Traditional and Hybrid Techniques*. 1st ed. London: Bloomsbury.
- CENTRE for Fine Print Research Symposium and Exhibition: 3D Print Technologies and their Creative Application in the Arts and Crafts. Available from: http://www.uwe.ac.uk/sca/research/cfpr/research/3D/research_projects/2009_symposium.html [Accessed 26 March 2016].
- CENTRE for Fine Print Research Woodburytype Archive. Available from: <http://www.uwe.ac.uk/sca/research/cfpr/dissemination/archives/woodburytype.html> [Accessed 27 May 2016].
- CHARLES, P. and Faujat, S. (1900) Machine for Production of Gelatine Pictures in Connection with Photography Anon. .
- CHATTERJEE, A.C. (2004) Europe struggles over software patents. *IEEE Spectrum* [online]. 41 (9), pp.61-63.
- CHELIOTIS, G. (2009) From open source to open content: Organization, licensing and decision processes in open cultural production. *Decision Support Systems* [online]. 47 (3), pp.229-244.
- CHEN, M. (2007) Entrepreneurial Leadership and New Ventures: Creativity in Entrepreneurial Teams. *Creativity and Innovation Management* [online]. 16 (3), pp.239-249.
- CLARKE, A. (06/02/1891) Photography in Coloured Inks. *British Journal of Photography*. XXXVIII .
- CLOSE, C. Chuck Close. *Two Palms Studios*, New York 2012. Available from: <http://www.twopalms.us/artists/chuck-close> .
- COE, B. and Haworth-Booth, M. (1983) *A Guide to Early Photographic Processes*. 1st ed. England: The Victoria and Albert Museum in Association with Hurtwood Press.
- COWAN, A. (1883) On Gelatino-Chloride Emulsion in the Camera. *The Photographic Journal*. 23 (March 30), pp.96-100.

- CRAWFORD, W. (1979) *The Keepers of Light. A History & Working Guide to Early Photographic Processes*. 1st ed. New York: Morgan & Morgan Ltd.
- CRESPO-BIEL, O., Ravoo, B.J., Reinhoudt, D.N. and Huskens, J. (2006) Noncovalent nanoarchitectures on surfaces: from 2D to 3D nanostructures. *Journal of Materials Chemistry* [online]. 16 (41), pp.3997.
- CROOKES, W. (1858) Mr. Fox Talbot's New Discovery: Photoglyptic Engraving. *Photographic News*. 1. No3 (24 September), pp.25-26.
- CROSS, N., ed. (23/11/1984) *Developments in Design Methodology*. 1st ed. Wiley.
- CULKIN, J. (1967, March 18) A schoolman's guide to Marshall McLuhan. *Saturday Review*. (March 18), pp.51-53, 71-72.
- CURTIN, L. and Simpson, R. (1999) Who owns your ideas? *Health Management Technology* [online]. 20 (6), pp.38.
- CURTIS, L. (2004) *Electroforming*. 1st ed. London: A&C Black Publishers Ltd.
- CYRANOSKI, D. Korea's Stem-Cell Stars Dogged by Suspicion of Ethical Breach. Available from: <http://www.nature.com/nature/journal/v429/n6987/full/429003a.html> [Accessed 04/05/2015].
- DAN Moren (2012) PRINT. *Macworld* [online]. 29(4), pp. 50.
- DAVIS, C. I Want to Spend a Penny, Not Go to the Shop: Nurses to be Taught Euphemisms. Available from: <http://www.theguardian.com/society/2010/aug/31/foreign-nurses-taught-english-euphemisms> [Accessed 04/05/2015].
- DAVIS, C., E., Salisbury, H., M. and Harvey, M.T. (1924) Surface Tension of Gelatin Solutions. *Industrial and Engineering Chemistry*. 16 (2), pp.161-163.
- DAWSON, A. (1892) Photogravure. *The Photographic Journal*. 32 (June 28), pp.290-297.
- DE Courten, Comte Ludovico M. (15/11/1872) A Frenchman's Notes on Germany. *British Journal of Photography*. XIX .
- DE La Rue, W. (1871) Report on the Total Eclipse of the Sun, August 18 1868. *The Photographic Journal*. 15 (March 21), pp.67.
- DE Rigal, J., Abella, M., Giron, F., Caisey, L. and Lefebvre, M.A. (2007) Development and validation of a new Skin Color Chart®. *Skin Research and Technology* [online]. 13 (1), pp.101-109.
- DE Wiveleslie Abney, Sir William (29/05/1896) Scientific and History Preliminary (Photography with the Bichromate Salts). *The Photographic Journal*.
- DEBENHAM, W.E. (1896) Affiliation of Photographic Societies. Six Lectures on "Photography with the Bichromate Salts" iii) Collotype. *The Photographic Journal*. 36 (May 29), pp.265-270.

- DENSCOMBE, M. (2010) *The Good Research Guide: For Small-Scale Social Research Projects*. 4th ed. UK: Open University Press.
- DESROCHERS, P. (2000) Excludability, creativity and the case against the patent system. *Economic Affairs* [online]. 20 (3), pp.14-16.
- DEVULDER, G. (05/08/1870) Some Accounts of an Antwerp Process of Phototypy. *British Journal of Photography*. XVII .
- DIAMOND, H.W. (1867) Official Reports of the French Exhibition. Class 9, Photographic Proofs and Apparatus, Section 1, Permanent Printing. *The Photographic Journal*. 12 (October 15), pp.113-120.
- ANON. (2012) *Proceedings of the ACM SIGGRAPH Symposium on Interactive 3D Graphics and Games*. ACM.
- DOMMASCH, H.S. and Silversides, B. (1989) The Silver Image. *Cartes De Visites and the Albumen Process*. *The Photographic Journal*. 129 (September), pp.435-437.
- DOUBLEDAY, D. Barkman, A. The Sherwin-Williams Co. (1950) Reading the Hegman Grind Gauge. *Paint, Oil & Chemical Review*. (June 22), pp.34.
- DUARTE, N. (2008) *Slide:Ology: The Art and Science of Creating Great Presentations: The Art and Science of Presentation Design*. 1st ed. O'Reilly Media.
- DUTFIELD, G.M. and Suthersanen, U. (2004) The innovation dilemma: intellectual property and the historical legacy of cumulative creativity. *Intellectual Property Quarterly* [online]. (4), pp.379.
- EDER, J.M. (1978) *History of Photography*. 4th ed. USA: Dover.
- EDER, J.M. (1932) *Geschichte Der Photographie*. 4th ed. Germany: .
- EDITOR (1884) ? *Leipzig Illustrierte Zeitung ("Illustrated News")*.
- EDWARDS, E. (26/05/1871) On Photography on the Printing Press, Being a Description of the Working of the Heliotype Process (Part 4). *Photographic News*. XV .
- EDWARDS, E. (1871) On Photography in the Printing Press, Being a Description of the Working Heliotype Process. *The Photographic Journal*. 15 (May 16), pp.76-84.
- EDWARDS, E. (15/03/1895) Photo-Mechanical Printing Processes. *British Journal of Photography*. XLII .
- EDWARDS, E. (15/02/1895) Photo-Mechanical Printing Processes (Part 1). *British Journal of Photography*. XLII .
- EDWARDS, E. (05/05/1871) On Photography in the Printing Press, Being a Description of the Working of the Heliotype Process (Part 1). *Photographic News*. XV .
- ELDER, D.J.M. (09/07/1886) Extract - The Progress of Photography in Germany and Austria. *British Journal of Photography*. XXXVIII .

- ELLIS, E. (2010) *Planned Spontaneity: Modular System of Relief Printing for Platen Presses*. Aberystwyth University.
- ESQUIVEL, P. (April 12th, 2015) 15 Years After 'Erin Brockovich,' Town Still Fearful of Polluted Water. Available from: <http://www.latimes.com/local/california/la-me-hinkley-20150413-story.html> [Accessed Jan 19th, 2016].
- ESTRADA, N., Engelfried, J. and Morelos, A. (2005) Ronchi test for flat mirrors. *Nuclear Instruments and Methods in Physics Research Section A: Accelerators, Spectrometers, Detectors and Associated Equipment* [online]. 553 (1-2), pp.172-176.
- EVANS, F.H. (1886) Photo-Micrography. *The Photographic Journal*. 26 (December 31), pp.25.
- EXELEY, K. and Dennick, R. (2004) *Giving a Lecture, from Presenting to Teaching*. Key Guides for Effective Teaching in Higher Education. 1st ed. London: Routledge Falmer, Taylor & Francis Group.
- EXELEY, K. and Dennick, R. (2004) *Small Group Teaching, Tutorials, Seminars and Beyond*. Key Guides for Effective Teaching in Higher Education . 1st ed. London: Routledge Falmer, Taylor & Francis Group.
- FACTUM-ARTE (2016) Woodburytype Prints. Available from: <https://vimeo.com/149420025> [Accessed 27 May 2016].
- FACTUM-ARTE Woodburytype Prints: Redeveloping a 19th Century Print Process. Available from: <http://www.factum-arte.com/pag/731/-span--span-Woodburytype--span---span--Prints---br--Redeveloping-a-19th-century-print-process> [Accessed 27 May 2016].
- FAIRMAN, H.S., Brill, M.H. and Hemmendinger, H. (1997) How the CIE 1931 Color-Matching Functions Were Derived from Wright-Guild Data. *COLOR Research and Application*. 22 (1 February), pp.11-23.
- FARMER, H. (1892) Preliminary Note on some Remarkable Properties of Silver and Gelatine. *The Photographic Journal*. 33 (November 25), pp.30-32.
- FATUZZO, G., Mussumeci, G., Oliveri, S.M. and Sequenzia, G. (2011) The "Guerriero di Castiglione": reconstructing missing elements with integrated non-destructive 3D modelling techniques. *Journal of Archaeological Science* [online]. 38 (12), pp.3533 <last_page> 3540.
- FAUSTMAN, C. and Cassens, R.G. (1990) The biochemical basis for discoloration in fresh meat: a review. *Journal of Muscle Foods*. 1 (2), pp.217-243.
- FERNANDES, L.J.O. (2008) *Characterization and Identification of Printed Objects*. Universidade de Nova de Lisboa. https://run.unl.pt/bitstream/10362/1763/1/Fernandes_2008.pdf.

- FERRIOLO, S. and Shayn Ferriolo (01) Goodbye, halftones; hello, stochastic? *Catalog Age* [online]. 19 (3), pp.7; 7.
- FISHENDEN, R.B. (1949) Editorial Review - Collotype. *Penrose Pictorial Annual*.
- FORMAN, H. (2006) From cheerleader to patent processor. *The Journal of Nursing Administration* [online]. 36 (7-8), pp.346-350.
- FOWLER, R.J. (24/05/1867) The History of the Processes for the Production of Permanent Photographic Pictures in Printers' Inks (Part 2). *British Journal of Photography*. XIV .
- FRAYLING, C. (1993) *Research in Art and Design*. Royal College of Art Research Papers. 1 (1), .
- FRIZOT, M. (1998) *The New History of Photography*. 1 (English) ed. Koln: Konemann.
- GAMBLE, W. (26/03/1897) The Camera and the Printing Press (Part 2). *Photographic News*. XLI .
- GAMBLE, W. (1897) The History of the Half-Tone Dot. *The Photographic Journal*. 37 (February 20), pp.126-136.
- GAMBLE, W. (18/10/1895) Photo-Mechanical Notes. *British Journal of Photography*. XLII .
- GAMBLE, W. (08/10/1897) The Printing Processes of the Future. *British Journal of Photography*. XLIV .
- GAMLIN, J.N., Yourd, R. and Patrick, V. (2007) Unlock Creativity with "Active" Idea Management. *Research-Technology Management* [online]. 50 (1), pp.13-13.
- GASCOIGNE, B. (2004) *How to Identify Prints. A Complete Guide to Manual and Mechanical Processes from Woodcut to Inkjet*. 2nd ed. London: Thames & Hudson.
- GATTER, M. (2005) *Getting it Right in Print: Digital Pre-Press for Graphic Designers*. 1st ed. Laurence King.
- GEDDES, J.D. (29/05/1869) Woodburytype Printing (Photography with the Bichromate Salts). *The Photographic Journal*.
- GEDDES, J.D. (1896) Affiliation of Photographic Societies. Six Lectures on "Photography with the Bichromate Salts" iv) Woodbury Printing. *The Photographic Journal*. 36 (May 29), pp.270-273.
- GEDDES, J.D. (17/10/1902) Photography as Applied to Illustrations and Printing (Part 2). *British Journal of Photography*. XLIX .
- GEDDES, J.D. (10/10/1902) Photography as Applied to Illustration and Printing (Part 1). *British Journal of Photography*. XLIX .

- GEDENRYD, H. (1998) How Designers Work. Making Sense of Design as a Cognitive Activity. PhD, Lund University Cognitive Studies. <http://lucs.fil.lu.se/people/henrik.gedenryd>.
- GEORGE, J.H. and Doto, F.X. (2001) A Simple five step method for teaching clinical skills. *Family Medicine*. 33 pp.577.
- GERNSHEIN, H. and Gernshein, A. (1987) *The History of Photography Volume II. the Rise of Photography 1850-1880. the Age of Collodion*. 3rd ed. London: Thames and Hudson.
- GERNSHEIN, H. and Gernshein, A. (1955) *The History of Photography. from the Earliest use of the Camera Obscura in the Eleventh Century Up to 1914*. 1st ed. London: Oxford University Press.
- GIBSON, I., Rosen, D. and Stucker, B. (2014) *Additive Manufacturing Technologies: 3D Printing, Rapid Prototyping, and Direct Digital Manufacturing*. 2nd ed. Springer.
- GILBERT, G.T. *Photography: The Early Years: A Historical Guide for Collectors* [online]. New York ; Harper & Row, c1980.
- GILL, A.T. (1970) One Hundred Years Ago. *The Photographic Journal*. 110 (August), pp.334-335.
- GILL, A.T. (1970) One hundred years ago. *Photographic Journal*. (August), pp.334-335.
- GILL, A.T. (1969) One Hundred Years Ago. *The Photographic Journal*. 109 (March), pp.158-159.
- GILL, A.T. (1969) One Hundred Years Ago. *The Photographic Journal*. 109 (October), pp.590-591.
- GILL, A.T. (1969) One Hundred Years Ago. *The Photographic Journal*. 109 (November), pp.619-621.
- GLASGOW Print Studio Blueprint. Available from: http://www.trongate103.com/129,156,2045/partners/glasgow_print_studio/blueprint_2013_glasgow_print_studio/ [Accessed 04/05/2015].
- GLASS, R.L. (2009) Creativity vs. the law. *Information Systems Management* [online]. 26 (1), pp.88-89.
- GOETHE, J.W.v. (1840) *Theory of Colours* (English Translation). John Murray.
- GONZALEZ, R.C. and Woods, R.E. (2008) *Digital Image Processing*. 3rd ed. USA: Pearson.
- GOOGLE Google Scholar. Available from: <https://scholar.google.co.uk> [Accessed 27 May 2016].
- GOOGLE Youtube. Available from: <https://www.youtube.com> .
- GORDON Rugg And Marian Petre. (2006) *A Gentle Guide to Research Methods* [online]. GB: Open University Press.

- GRANZIER, J.J.M. and Gegenfurtner, K.R. (2012) Effects of memory colour on colour constancy for unknown coloured objects. *I-Perception*. 3 pp.190-215.
- GRAY, C. and Malins, J. (2004) *Visualizing Research. A Guide to the Research Process in Art and Design*. Ashgate Publishing Limited.
- GREEN, P. (1995) *Understanding Digital Colour*. 1st ed. Pittsburg, Pennsylvania, USA: Graphic Arts Technical Foundation.
- GREENFIELD, T., ed. (1996) *Research Methods – Guidance for Postgraduates*. New York: Arnold Publishing.
- GREENFIELD, T. (1969) *Ethics of Research, Research Methods – Guidance for Postgraduates*. Arnold Publishing.
- HALLEWELL ST JOHNSTON, J. and Peard, G.T. (1925) CIII. THE SURFACE TENSION OF GELATIN SOLUTIONS. (PART II.). *Biochemical Journal*. 19 (2), pp.816-824.
- HAMMOND, A., ed. (1992) *Fredrick H. Evans. Selected Texts and Bibliography*. 1st ed. England: Clio Press.
- HANNAVY, J., ed. (2008) *Encyclopedia of Nineteenth-Century Photography Volume 1 A-I*. Taylor & Francis group.
- HANNAVY, J., ed. (2008) *Encyclopedia of Nineteenth-Century Photography*. 1st ed. USA: Routledge.
- HANSON, D.A. (2005) John Carbutt and the Woodburytype in America. In: Anon.(2005) *Printing History*. New York: American Printing History Association, pp.41-54.
- HANSON, D.A. (2005) John Carbutt and the Woodburytype in America. In: Anon.(2005) *Printing History*. New York: American Printing History Association, pp.41-52.
- HARVIE, D., I. (1999) The radium century. *Endeavour*. 23 (3), pp.100-105.
- HAYTON, J. (2015) *PhD, an Uncommon Guide to Research, Writing & PhD Life*. 1st ed. James Hayton PhD.
- HEALTH and Safety Executive Printing Publications. Available from: <http://www.hse.gov.uk/printing/information.htm> [Accessed 04/05/2015].
- HEATH, V. (06/03/1874) The Autotype and other Photographic Processes and Discoveries. *British Journal of Photography*. XXI .
- HEDRICH, M., Bloj, M. and Ruppertsberg, A.I. (2009) Color constancy improves for real 3D objects. *Journal of Vision*. 9(4) (16), pp.1-16.
- HERBERT Jones, A. (1977) A Pattern of Pictorialism. *The Photographic Journal*. 117 (March / April), pp.70-71.
- HERBERT, E. (2013) OAM for Alan Elliott ARPS. *RPS Journal*. 152 (March), pp.68.

- HERBERT, E. (2006) A Celebratory Tome. *RPS Journal*. 145 (July / August), pp.258-261.
- HERBERT, E. (2001) RPS Overseas - Victorian Chapter. G'Day, Australians see (and cook) it their way. *RPS Journal*. 141 (April), pp.130.
- FARNAND, S.P. and Gaykema, F., eds. (2009) Perception of Detail in 3D Images. 2009. SPIE.
- HOEGL, M., Parboteeah, K.P. and Muethel, M. (2012) Cross-National Differences in Managers' Creativity Promoting Values. *Management International Review [online]*. 52 (4), pp.565-595.
- HORGAN, S.H. (1929) Bringing Photography to the Printing Press. *The Photographic Journal*. 69 (August), pp.355.
- HOSKINS, S., (May/June 2012) 3D printing in clay. *Ceramic Review*. 255 (May/June), pp. 64*65.
- HOSKINS, S. (2013) *3D Printing for Artists, Designers and Makers*. 1st ed. London: Bloomsbury Publishing Plc.
- HOWE Ashton, R. (1867) Obtaining Printing and Embossing Surfaces. *The Photographic Journal*. 12 (September 16), pp.108.
- HOWE Ashton, R. (1867) Printing and Carving Surfaces. *The Photographic Journal*. 12 (September 16), pp.108-109.
- HOWE Ashton, R. (1866) Colouring photo relief prints. *Photographic News*. X (432 December 14), pp.599.
- HUME, N. (2011) The Nature Print and Photography in the 1850s. *History of Photography*. 35 (1), pp.44-58.
- HUME, W. (18/01/1895) Remarks on Photographic Colour Printing (Part 2). *Photographic News*. XXXIX .
- I.H.J (10/12/1886) Photo-Zincotypy and Other Photographic Printing Methods for the Printing Press. *British Journal of Photography*. XXXIII .
- IBRAHIM, S.E., Fallah, M.H. and Reilly, R.R. (2006) Do Localized Clusters Influence Creativity of Inventors? *Creativity and Innovation Management [online]*. 15 (4), pp.410-418.
- IMPACT Impact 8 - Borders and Crossings, the Artist as an Explorer. Available from: <http://www.conf.dundee.ac.uk/impact8/schedule/> [Accessed 04/05/2015].
- INTERNATIONAL Standards Organisation (1974) ISO 838:1974 Paper - Holes for General Filing Purposes - Specifications. International Standards Organisation.
- IVES, F.E. (1900) The Optics of Trichromatic Photography. *The Photographic Journal*. 41 (November 30), pp.99-120.

JAMES, B.R., Petura, J.C., Vitale, R.J. and Mussoline, G.R. (1997)

Oxidation–reduction chemistry of chromium: Relevance to the regulation and remediation of chromate–contaminated soils *Journal of Soil Contamination*. 6 (6), pp.569-580.

JEFFERSON, T. Article 1, Section 8, Clause 8: Document 12 Thomas Jefferson to Issac McPherson 13 Aug. 1813 *Writings* 13:333--35. Available from: http://press-pubs.uchicago.edu/founders/documents/a1_8_8s12.html [Accessed 4/15/2013].

JOHNSON, H. (2005) *Mastering Digital Print*. 2nd ed. USA: Thomson Course Technology PTR.

JONES, C. (30/03/1888) The Use of Chromated Gelatine in Photo-Lithography, Photo-Zincography, In Collotype, In Getting Gelatine Reliefs. *Photographic News*. XXXII .

JOURNAL, P. (1896) Answers to Correspondents. *British Journal of Photography*. (January 17), pp.48.

JOURNAL, P. (1871) *The Photographic Journal*. 225 (May 16), pp.81.

JOURNAL, P. (1869) Miscellaneous. *The Photographic Journal*. 13 (January 16), pp.218.

JOURNAL, P. (1867) The Times on the great French exhibition. *The Photographic Journal*. 11 (November 16), pp.134-140.

JOURNAL, P. (1865) New Method of Photo-relivo Printing. *The Photographic Journal*. (September 15), pp.150-153.

JOURNAL, P. (1865) A New Photo-Relief Printing Process. *The Photographic Journal*. (Decemberr 15), pp.202.

JOURNAL, P. (1864) A New Method of Carbon Printing. *The Photographic Journal*. (April 15), pp.20-25.

KERR, P. Career Resilience. Available from: <http://www.careers.govt.nz/educators-practitioners/career-practice/archive/career-resilience-june-2009> [Accessed 04/05/2015].

KIEF, H.B. and Roschiwal, H.A. (2013) *CNC Handbook*. 2nd ed. USA: McGrawHill.

KIMBROUGH, D.E., Cohen, Y., Winer, A.M., Creelman, L. and Mabuni, C. (1999) A Critical Assessment of Chromium in the Environment. *Critical Reviews in Environmental Science and Technology*. 29 (1), pp.1-46.

KIMPE, T. and Tuytschaever, T. (2007) Increasing the Number of Gray Shades in Medical Display Systems—How Much is Enough? *Journal of Digital Imaging*. 20 (4), pp.422-434.

KING, S. (2003) *The Book of Carbon and Carbro*. Contemporary Procedures for Monochrome Pigment Printmaking. 1st ed. Greenville, South Carolina: Permanent Light Systems.

- KIPPHAN, H. (2001) Handbook of Print Media. 1st ed. Germany: Springer-Verlag Berlin Heidelberg New York.
- KITSON, R.E. and MELLON, M.G. (1944) Color of Aqueous Potassium Dichromate Solutions. *Industrial and Engineering Chemistry*. 16 (1), pp.42-44.
- KLIMASZEWSKI, N. Nicolai Klimaszewski. *Photography / Printmaking / Sculpture*. Available from: <http://www.klimko.com> [Accessed 27 May 2016].
- KLIMASZEWSKI, N. Woodbury-Process. Available from: http://www.klimko.com/mbr_bio.php [Accessed 26/03/2016].
- KLIMASZEWSKI, N. The Woodburytype Process. Available from: <http://www.alternativephotography.com/wp/processes/woodburytypes/the-woodburytype-process> [Accessed 29/03/2016].
- KLIMASZEWSKI, N. The Woodburytype Process. Woodburytype, Woodbury-Process and Photo-Lithophane by Nicolai Klimaszewski. Available from: <http://www.alternativephotography.com/wp/processes/woodburytypes/the-woodburytype-process> [Accessed 27 May 2016].
- KOPACZ, J. *Color in Three-Dimensional Design* [online]. New York ; McGraw-Hill, c2004.
- KOSAR, J. (1965) *Light-Sensitive Systems: Chemistry and Application of Nonsilver Halide Photographic Processes*. New York: John Wiley & Sons.
- KOSCHAN, A. and Abidi, M. (2008) *Digital Color Image Processing*. 1st ed. USA & Canada: John Wiley & Sons.
- KOUTSOUDIS, A., Pavlidis, G., Arnaoutoglou, F., Tsiafakis, D. and Chamzas, C. (2009) Qp: A tool for generating 3D models of ancient Greek pottery. *Journal of Cultural Heritage* [online]. 10 (2), pp.281 <last_page> 295.
- ANON. (2002) [online]. Available from: <http://dx.doi.org/10.1145/1242073.1242215>.
- KRONE, M. (12/08/1870) M. Krone on Albert-Type. *Photographic News*. XIV .
- LAIDLER, P. (2011) *Collaborative Digital and Wide Format Printing: Methods and Considerations for the Artist and Master Printer*. University of the West of England.
- LAMBERT, N. *Codes of Engagement* 8th – 10th April 2013 Watershed, Bristol. Available from: http://www.lambertsblog.co.uk/?page_id=144 [Accessed 04/05/2015].
- LANG Jun, W. (26/04/1889) Extract - Fifty Years of Photography. *British Journal of Photography*. XXXVI .
- LANGFORD, M. (1981) *The Darkroom Handbook. A Complete Reference Manual of Processing, Printing, and Manipulative Techniques*. 8th ed. London: Ebury Press.
- LAU, D.L. and Ace, G. (2008) *Modern Digital Halftoning*. 2nd ed. CRC Press, Taylor & Francis Group.

- LAWLER, B.P. (2006) *The Official Adobe Print Publishing Guide*. 2nd ed. USA: Adobe Press.
- LAWLOR, M.C. (2016) About Luis Nadeau. Available from: http://www.photoconservation.com/index.php?option=com_content&view=article&id=46&Itemid=55 [Accessed 03/07/2016].
- LEE, H. (2005) *Color Imaging Science*. 1st ed. UK: Cambridge University Press.
- LEFTERI, C. (2012) *Making it : Manufacturing Techniques for Product Design*. 2nd ed. London: Laurence King.
- LEONARD D DuBoff (2008) The World is a Showcase for Creative People. *Techtrends* [online]. 52 (2), pp.8-11.
- LESSIG, L. (2004) *Free Culture: How Big Media Uses Technology and the Law to Lock Down Culture and Control Creativity* [online]. New York: Penguin.
- LEUNG, H., Wong, S.T.S. and H.S., H. (2008) In the Name of Art Preserving archaic Chinese calligraphy and reproducing its dynamic brush writing. *IEEE Signal Processing Magazine*. (July), pp.49-50 - 54.
- LIBRARY of Congress Library of Congress. Available from: <https://www.loc.gov> [Accessed 27 May 2016].
- LIPSON, H. and Kurman, M. (2013) *Fabricated. the New World of 3D Printing*. 1st ed. USA: John Wiley & Sons, Inc.
- LISTER, R. (1984) *Prints and Printmaking. A Dictionary and Handbook of the Art in Nineteenth Century Britain*. 1st ed. London: Melhuen London Ltd.
- LOWE, A. (1997) *Digital Prints*
Conceived and Edited by Adam Lowe [50 pages Edition of 50 box sets plus 500 hardback books]. At: London: Permaprint London.
- LUNDSTRÖM, J., Verikas, A., Tullander, E. and Larsson, B. (2013) Assessing, exploring, and monitoring quality of offset colour prints
. *Journal of the International Measurement Confederation (IMEKO)*. 46 pp.1427-1441.
- MATTHIJS, P. (2003) *Grayscale resolution: How much is enough?* Barco Medical White Paper.
- MC Dowell Patterson, Austin M (1921) *A French-English Dictionary for Chemists 1876-1956*. illustrated reprint ed. BiblioLife, 2015.
- MCCAMY, C.S., Marcus, H. and Davidson, J.G. (1976) A Color-Rendition Chart. *Journal of Applied Photographic Engineering*. 2 (3, Summer), pp.95-99.
- MCCANN, S. (2011) Conservatism, Openness, and Creativity: Patents Granted to Residents of American States. *Creativity Research Journal* [online]. 23(4), pp. 339-345.

- MCCULLOUGH, M. (2010) Chap. 40 In *The Craft Reader*. In: Adamson, G., ed. (2010) *Abstracting Craft: The Practiced Digital Hand*. Oxford: Berg, pp.310-316.
- MCCULLOUGH, M. (1998) *Abstracting Craft: The Practiced Digital Hand*. 2 (Paperback) ed. United States of America: Massachusetts Institute of Technology (MIT Press).
- MCLUHAN, M. (1967) *The Medium is the Message, an Inventory of Effects*. Germany: Ginko Press, California.
- MCLUHAN, M. (1964) *Understanding Media, the Extensions of Man*. Critical edition (November 1, 2003) ed. Germany: Ginko Press; California.
- MCLUHAN, M. (1962) *The Gutenberg Galaxy*. Centennial ed edition (July 31, 2011) ed. University of Toronto Press, Scholarly Publishing Division;.
- MEALING, S. *Computers and Art* [online]. Intellect Ltd.
- MELVIN, M. (2009) In the Footsteps of Walter Woodbury. *RPS Journal*. 149 (February), pp.28-31.
- MERTLE, J.S. (1957) The Woodburytype. The most beautiful photographic reproduction process ever invented. *Image.the Journal of Photography and Motion Pictures of the George Eastman House*. 53 (September), pp.165-170.
- MILLER, D. (2011) The Power of Making. In: Charny, D., ed. (2011) *Power of Making, the Importance of being Skilled*. London: V&A Publishing and the Crafts Council, pp.14.
- MILLER, J. (1971) *Mcluhan*. 3 (1975) ed. Great Britain: Fontna / Collins.
- MUJUMDAR, A. (2013) Editorial: On Right-Brain Activity to Stimulate Creativity in Academic R&D. *Drying Technology* [online]. 31 (3), pp.253-254.
- NADEAU, L. (1994) *Encyclopedia of Printing, Photographic, and Photomechanical Processes: A Comprehensive Reference to Reproduction Technologies, Containing Invaluable Information on Over 1500 Processes* [online]. Fredericton, N.B., Canada : L. Nadeau, c1989-c1990.
- NADEAU, L. (1987) *Gum Dichromate and Other Direct Carbon Processes from Artigue to Zimmerman*. 1st ed. Canada: Atelier Luis Nadeau.
- NADEAU, L. (1986) *Modern Carbon Printing: A Practical Guide to the Ultimate in Permanent Photographic Printing: Monochrome Carbon Transfer and Carbro* [online]. Fredericton, New Brunswick: Atelier Luis Nadeau.
- NARAYANAN, R.M., Sankaravadevelu, T.S. and Reichenbach, S.E. (2000) Dependence of Image Information Content on Gray-Scale Resolution. *Geoscience and Remote Sensing Symposium, 2000. Proceedings*.
- NEWBURY, D. (1996) Knowledge and research in art and design. *Design Studies*. 17 pp.215-219.

- NEWHALL, B. (1964) *The History of Photography*. 1st ed. New York: The Museum of Modern Art, New York.
- NEWTON, A.J. (1913) The Evolution of Photomechanical Illustration. *The Photographic Journal*. 53 (June), pp.206-212.
- NEWTON, C. (1979) *Photography in Printmaking*. 1st ed. London: Victoria and Albert Museum.
- NEWTON, G. (2007) Leo Haks: Indonesian photographs collection 1860s-1940s. *Artonview* [online]. (52), pp. 36-41.
- NEWTON, G. (2007) Serimpies, or dancing girls of the Sultano. *Artonview* [online]. (50), pp. 49-49.
- O'NEILL, J., Martin, D., Colombino, T., Roulland, F. and Willamowski, J. (2008) Colour Management is a Socio-technical Problem. *Proceedings on the 2008 ACM Conference on Computer Supported Cooperative Work*. November 8-12 pp.599-608.
- OFFICER, L.H. and WILLIAMSON, S.H. (2016) Measuring Worth Purchasing. Power of Money in the United States from 1774 to 2010. Available from: <https://www.measuringworth.com/ukcompare/relativevalue.php> [Accessed 03/06/2016].
- OLIAR, D. and Sprigman, C. (2008) There's No Free Laugh (Anymore): The Emergence of Intellectual Property Norms and the Transformation of Stand-Up Comedy. *Virginia Law Review* [online]. 94 (8), pp.1787-1867.
- OTT, A. (25/06/1880) Examination and Selection of Gelatine for Photo-Mechanical Printing. *Photographic News*. XXIV .
- OXFORD English Dictionary (2001) Method. Available from: <http://www.oed.com/view/Entry/117560?rkey=Pcmncl&result=1#eid> [Accessed 27/05/2016].
- OXFORD English Dictionary (2001) Methodology. Available from: <http://www.oed.com/view/Entry/117578?redirectedFrom=Methodology&> [Accessed 27/05/2016].
- OXFORD English Dictionary Definition of Print. Available from: <http://www.oed.com/view/Entry/151479?rkey=5vi38j&result=1&isAdvanced=false#eid> .
- PANTONE Pantone. Available from: <http://www.pantone.com/pages/pantone/index.aspx> .
- PARCHOMOVSKY, G. and Stein, A. (2009) Originality. *Virginia Law Review* [online]. 95 (6), pp.1505-1550.
- PARRAMAN, C. (2012) Colour print workflow and methods for multilayering of colour and decorative inks using UV inkjet for fine art printing. *Proceedings of SPIE* [online]. 8292 (1), pp.82920Z-82920Z-12.

- PARRAMAN, C., ed. (2001) *A Survey of Photomechanical Prints* [Essays by Carinna Parraman, Paul Thirkell, Elizabeth Turrell and Michael McGraw]. 1st ed. Bristol, UK: Impact Press.
- ESCHBACH, R. and Marcu, G. G., eds. (2003) *Colour Imaging VIII; Processing, Hardcopy and Applications*. 21-24 January. SPIE.
- PATTERSON, A.M. (1926) The History of the Word "Alum". *Industrial and Engineering Chemistry*. 18 (6), pp.634-635.
- PÉREZ-CARPINELL, J., Camps, V.J. and Trottini, M. (2008) Color memory in children. *Color Research & Application* [online]. 33 (5), pp.372-380.
- PÉREZ-CARPINELL, J., Camps, V.J., Trottini, M. and Pérez-Baylach, C.M. (2006) Color memory in elderly adults. *Color Research & Application* [online]. 31 (6), pp.458-467.
- PERRA, D.P. and Gandolfi, E. (2010) *Low Cost Design* [online]. Milano: Silvana.
- PETERSON, K.A., (June 2005) *Introduction to Basic Measures of a Digital Image for Pictorial Collections*. Washington, USA: Library of Congress.
- PETTITT, C. (2004) *Patent Inventions--Intellectual Property and the Victorian Novel* [online]. Oxford: Oxford University Press.
- PHILLIPS, E.M. and Derek S. Pugh *How to Get a PhD: A Handbook for Students and their Supervisors* [online]. Open University Press.
- PHILPOTTS, T. (2007) Dickens, invention, and literary property in the 1850s (Charles Dickens). *Dickens Quarterly* [online]. 24 (1), pp.18-26.
- PHOTOGRAPHIC Journal (1867) *The Photographic Journal*. (January 15), pp.177.
- PHOTOGRAPHIC News (1877) M.Lambert and Carbon in the United States. *Photographic News*. XXI (January 19), pp.30.
- PHOTOGRAPHIC News (1877) New Combination Process. *Photographic News*. (May 11), pp.P228.
- PLATZKER, D. and Wyckoff, E. (2000) *Hard Pressed: 600 Years of Prints and Process* [online]. New York: Hudson Hill Press.
- POLYTEK Development Corp.
Physical Properties of EasyFlo-Series LiquidPlastics Available from: <http://www.polytek.com/images/Physical%20Properties/EasyFlo%201-11-2008.pdf> [Accessed 21/09/2015].
- PONTON, M. (1839) Notice of a cheap and simple method of preparing paper for photographic drawing, in which the use of any salt of silver is dispensed with. *The Edinburgh New Philosophical Journal*. (July), .

- PRINTING and Graphics Science Group Science of Inkjet and Printed Drops 2012. Available from: <http://www.iop.org/activity/groups/subject/pgs/calendar/index.html?trumbaEmbed=view%3Devent%26eventid%3D97771730> [Accessed 04/05/2015].
- PRITCHARD, H.B. (26/08/1870) The Woodbury and the Lichtdruct Processes Compared. *Photographic News*. XIV .
- PRITCHARD, H.B. (1869) Our Printing Processes in the Future. *The Photographic Journal*. 14 (September 15), pp.113.
- QUALITY Assurance for Higher Education (2011) the UK Doctorate – a Guide for Current and Prospective Doctoral Candidates.
- QUENTIN Hardy (2002) Search 500,000 Documents, Review 160,000 Pages In 20 Hours, And Then Do It All Over Again. *Forbes ASAP* [online]. 169 (14), pp.050.
- READ, H. (1958) *Education through Art*. 3rd ed. Faber & Faber.
- REDFERN, M., Keeling, J. W. and Powell, E. (2001) *The Royal Liverpool Children's Inquiry*. .
- REESE, J.J.R. and Hoesen, P.P.V.V. (2006) Maybe it's time: Making print simple™. *Journal of Digital Asset Management* [online]. 2 (6), pp.293-295.
- ROBINSON, D., Herbert, S. and Crangle, R., eds. (2001) *Encyclopaedia of the Magic Lantern*. UK: The Magic Lantern Society.
- ROLAND DG Coporation (2006-2008) *Modela Pro 2 MDX-540s MDX-540 User's Manual*. Roland DG Corporation.
- ROYAL Photographic Society The RPS Journals. Available from: <http://archive.rps.org> [Accessed 27 May 2016].
- RUSS, J.C. (2011) *The Image Processing Handbook*. 6th ed. United States of America: CRC Press Taylor & Francis Group.
- SAHA, R., Nandi, R. and Saha, B. (2011) Sources and toxicity of hexavalent chromium. *Journal of Coordination Chemistry*. Vol 64, No 10 (20 May 2011), pp.1782-1806.
- SALTER, R. (2001) *Japanese Woodblock Printing* [online]. London: A. & C. Black.
- SANGER Shepherd, E. (1897) A Review of Triple Printing Methods. *The Photographic Journal*. 38 (December 24), pp.96-103.
- SANTANDER Santander Scholarships. Available from: <http://www1.uwe.ac.uk/students/feesandfunding/fundingandscholarships/santanderscholarships.aspx> [Accessed 04/05/2015].
- SAWYER, J.R. (1501/1872) Phorography in the Printing Press. *The Photographic Journal*.
- SCHAAF, M. Michael Schaaf Photography. Available from: <http://mics-foto.de> [Accessed 27 May 2016].

SCHMIDT, K.F. (1971) Continuous-tone lithography. Print (New York) [online]. 25 pp.70.

SCHNAUSS, H. (01/01/1901) A New Modification of Woodburytype. Penrose Pictorial Annual.

SCNEIDER et al (Eds), ed. (2010) Im:Print 2010 [online]. <http://www.springer.com/architecture+&+design/printing+&+publishing/book/978-3-7091-0304-3> ed. SpringerWienNewYork. [Accessed 11/7/2012].

SEAN B Seymore (2011) Patently Impossible. Vanderbilt Law Review [online]. 64 (5), pp.1489.

SELIGER, H.H. (2002) Measurement of memory of color. Color Research & Application [online]. 27 (4), pp.233-242.

SHARMA, G., ed. (2003) Digital Color Imaging Handbook. USA: CRC Press.

REFERENCES:

SHEEN Instruments Physical Testing Data Sheet – Fineness of Grind Gauge. Available from: www.sheeninstruments.com/sites/sheeninstruments.com/files/SHE4-FineGrind.pdf [Accessed 25 September 2016].

SHEEN Instruments Physical Testing: Fineness of Grind Gauge. Available from: <http://www.sheeninstruments.com/sites/sheeninstruments.com/files/SHE4-FineGrind.pdf> [Accessed 21/09/2015].

SHIVA, V. (2001) Protect Or Plunder?: Understanding Intellectual Property Rights [online]. London: Zed Books.

SIDLES, C. (2001) Graphic Designer's Digital Printing and Prepress Hand Book. Rockford Publishers.

SIMPSON, W., G. (1864) A New System of Printing. Photographic News. (October 14), .

SINCLAIR, J.A. (1896) Affiliation of Photographic Societies. Six Lectures on "Photography with the Bichromate Salts" ii) Carbon Printing. The Photographic Journal. 36 (May 29), pp.259-265.

SMID, P. (2003) CNC Programming Handbook, A Comprehensive Guide to Practical CNC Programming. 2nd ed. United States of America: Industrial Press Inc.

SMITH, G. (1886) On the Production of Transparencies for the Optical Lantern by the Woodbury Process. The Photographic Journal. 26 (December 31), pp.22-25.

SMOOTH-ON Mold Making & Casting Calculators. Available from: <https://www.smooth-on.com/support/calculators/> [Accessed 11/09/2016].

SMOOTH-ON SLIC Pig® Pigments for Tin and Platinum Silicone Rubbers Technical Bulletin. Available from: https://www.smooth-on.com/tb/files/Silc_Pig_Pigments.pdf [Accessed 11/09/2011].

SMOOTH-ON SLIC Pig® Pigments Safety Data Sheet SDS no. 917A. Available from: https://www.smooth-on.com/msds/files/Silc_Pig.pdf [Accessed 11/09/2016].

SMOOTH-ON Smooth-on SORTA-Clear® 40 Safety Data Sheet SDS no.823A. Available from: https://www.smooth-on.com/msds/files/BD_DS_Eco_Equ_EZB_EZS_Psy_MS_OOMOO_Reb_ST_SS_Soma_Sol_Sorta.pdf [Accessed 11/09/2016].

SMOOTH-ON SORTA-Clear® Series Addition Cure Silicion Rubber Compounds Technical Bulletin. Available from: https://www.smooth-on.com/tb/files/SORTA_CLEAR_SERIES_TB.pdf [Accessed 11/09/2016].

SPILLER, J. (1883) Monthly Technical Meeting. *The Photographic Journal*. 23 (March 30), pp.100-101.

STANFORD University The Stanford Encyclopedia of Philosophy. Available from: <http://plato.stanford.edu> [Accessed 04/05/2015].

STEINBERG, S.H. and Trevitt, J. *Five Hundred Years of Printing* [online]. London : British Library ; 1996.

STEPHEN Bates (2008) No-No Names(TM). *The Wilson Quarterly* [online]. 32 (2), pp.14.

STERLING, B. (2011) The Future of Making. In: Charny, D., ed. (2011) *The Power of Making, the Importance of being Skilled*. London: V&A Publishing and the Crafts Council, pp.66.

STEVE Johnson (2007) Paper dolls. *American Printer* [online]. 124 (7), pp.49.

STOREY, M. (2005) Making spore prints. *Field Mycology* [online]. 6 (3), pp.104-106.

STULIK, D.C. and Kaplan, A. (2013) *Carbon*. 1st ed. United States: J.Paul Getty Trust.

STULIK, D.C. and Kaplan, A. (2013) *Salt Print*. 1st ed. United States: The Getty Conservation Institute.

STULIK, D.C. and Kaplan, A. (2013) *The Woodburytype*. 1st ed. United States: J.Paul Getty Trust.

STUMP, D. (2014) *Digital Cinematography: Fundamentals, Tools, Techniques, and Workflows*. 1st ed. US & UK: Focal Press, Taylor & Francis.

SULLIVAN, D. (2007) *The Bostick & Sullivan Book of Modern Carbon Printing*. 1st ed. Santa Fe, New Mexico: The Bostick & Sullivan Press.

SULTAN, T. (2014) *Chuck Close Prints: Process and Collaboration*. 1st ed. Prestel Verlag.

SUTTON, T. (25/10/1872) A Visit to the Works of the Heliochrome Company, at Kilburn. *British Journal of Photography*. XIX .

SUTTON, T. (15/11/1872) Correspondence - The Woodburytype; Comparison Between it and the Heliochrome [Suggested use of the Latter in Portraiture]. *British Journal of Photography*. XIX .

- SUTTON, T. (12/12/1873) Correspondence - M. Lemerrier's Albertypes; The Autotype Company's Lictdruct Specimens. *British Journal of Photography*. XX .
- SUTTON, T. (01/03/1870) A Week at the Woodbury - Printing Establishment of MM. Goupil at Ansieres, near Paris. *The Photographic Art Journal*.
- SUZUKI, S. (2011) Print People: A Brief Taxonomy of -Contemporary Printmaking. *Art Journal* [online]. 70(4), pp. 6-25.
- SUZUKI, S. (2011) What is a Print? Selections from the Museum of Modern Art. 1st ed. Ney York: The Museum of Modern Art.
- SWAN, J. (19/05/1865) Mr. Swan's Claim Versus Mr. Woodbury's. *British Journal of Photography*. XII .
- SWAN, J. (1878) Letter to Mr Bird. *The Photographic Journal*. 18 (April 9), pp.72-73.
- SWAN, J. (05/05/1865) Mr. Swan's Claim Versus Mr. Woodbury's. *British Journal of Photography*. XII .
- SWAN, J., Wilson. (1865, July 6) Improvements in the Production of Printing Surfaces by Photographic Agency, and in Obtaining Prints Therefrom. (British Patent 1791) Anon. .
- SWAN, J. (1864) A New Method of Carbon Printing. *The Photographic Journal*. (April 15), pp.20.
- TANKERSLEY, D. (2011) New Models for Ceramics: 3D Technology. *Ceramics Technical* [online]. (33), pp.54.
- TEMPONI, C., Farid Derisavi, F. and Corley, H.W. (1999) A fuzzy decision model for color reproduction. *International Journal of Production Economics*. 58 (1), pp.31-37.
- TENNANT, M.J.F. (1871) Report on the Total Eclipse of the Sun, August 17-18 1868. *The Photographic Journal*. 15 (March 21), pp.67.
- TERRY Corbitt (2004) Protecting your image. *Credit Management* [online]. pp.40.
- THE British Standards Institution (2013) Paints, varnishes and printing inks — Determination of fineness of grind (ISO 1524:2013). .
- THE British Standards Institution (2010) BS ISO 3664:2009. *Graphic Technology and Photography — Viewing Conditions* Incorporating Corrigendum January 2010. 2nd ed. BSI.
- THE British Standards Institution (1983) BS 3900-C6:1983 Methods of test for paints Part C6: Determination of fineness of grind — [ISO title: Paints and varnishes — Determination of fineness of grind]. .
- THE Image International Conference on the Image, Berlin 2014. Available from: <http://ontheimage.com/the-conference-2013/program-and-events/#Program> [Accessed 04/05/2015].

- THE Quality Assurance Agency for Higher Education (2011) The UK Doctorate. .
- THE RCUK Concordat the RCUK Concordat - Universities UK. Available from: <http://www.universitiesuk.ac.uk/Pages/default.aspx> [Accessed 04/05/2015].
- THE Royal Photographic Society, Victorian Chapter (2008) Walter Woodbury. A Victorian Study. 1st ed. Melbourne, Australia: RPS Victorian Chapter.
- THIRKELL, P. (9th December 2009) Bass Relief Imaging. 2D to 3D Notes on the Transition through Two CFPR Research Projects. Available from: http://www.uwe.ac.uk/sca/research/cfpr/research/3D/research_projects/2009_symposium/3D%20seminarPThirkell.pdf [Accessed 26/03/2016].
- THIRKELL, P., ed. (2004) Altered Images Digital Interpretations Inspired by George Cartlidge's Portrait Tiles. Bristol: MakingSpace Publishers.
- THIRKELL, P. (2000) The Integration of Digitally Mediated Imaging Techniques with 19th Century Continuous Tone Printing Processes. University of the West of England.
- THIRKELL, P. (2000) The Integration of Digitally Mediated Imaging Techniques with 19th Century Continuous Tone Printing Processes Paul Thirkell [online]. PhD, University of the West of England. Available from: [Accessed 11/7/2012].
- THOMAS, R.W. (1870) Is it possible to obtain Photographs in Colours? The Photographic Journal. 14 (December 16), pp.44.
- THOMAS, R.E. (2006) Vanquishing Copyright Pirates and Patent Trolls: The Divergent Evolution of Copyright and Patent Laws. American Business Law Journal [online]. 43 (4), pp.689-739.
- THOMPSON, R. (2007) Manufacturing Processes for Design Professionals. 1st ed. London: Thames & Hudson.
- TISSANDIER, G. (01/01/1876) A History and Handbook of Photography (Part II, Chapter II). A History and Handbook of Photography.
- DICARLO, J.M. and RODRICKS, B. G., eds. (2008) Does Resolution really Increase Image Quality?. San Jose, January 27. SPIE.
- TOOMS, M.S. (2016) Colour Reproduction in Electronic Imaging Systems: Photography, Television, Cinematography. 1st ed. UK: Wiley.
- TOPALIAN, A. (1980) The Management of Design Projects. 1st ed. London: Associated Business Press.
- TOULMIN, S.E. (2003) The Uses of Argument. 2nd ed. Cambridge University Press.
- TRAILL Taylor, J. (1888) Tuesday, August 28th, 1888. J. Traill Taylor, Member of Council, in the Chair. The Photographic Journal. 29 (November 30th), pp.19-20.

- TRITTON, F.J. (1949) Photography in Book Production. *The Photographic Journal*. 89 (November), pp.252-256.
- TRITTON, K. (1996) *Stochastic Screening*. Surrey, UK: PIRA International.
- TRUEMAN Wood, H. (03/02/1888) Photography and the Printing-Press. *Amateur Photographer*. VII .
- TRUSSELL, H.J., Lin, J. and Shamey, R. (2011) Effects of texture on color perception. *IEEE 10th IVMS Workshop: Perception and Visual Signal Analysis*. pp.7-11.
- TRUSSELL, H.J. and Vrhel, M.J. (2008) *Fundamentals of Digital Imaging*. 1st ed. USA: Cambridge.
- TWYMAN, M. (1970) *Printing 1770-1970 an Illustrated History of its Development and Uses in England* Michael Twyman. 1st ed. 1: Eyre & Spottiswoode.
- TWYMAN, M. *Printing 1770-1970 an Illustrated History of its Development and Uses in England* [online]. London Eyre & Spottiswoode 1970.
- UK Government Intellectual Property Office. *Searchable Patents Journal*. Available from: <https://www.ipo.gov.uk/p-pj> [Accessed 27 May 2016].
- UK Government National Archives. Available from: <http://www.nationalarchives.gov.uk> [Accessed 27 May 2016].
- UNIVERSITY of Lincoln *Rethinking Photography*. Available from: <http://www.rethinkingphotography.com> [Accessed 04/05/2015].
- UNIVERSITY of the West of England *Managing Research Data*. Available from: <http://www1.uwe.ac.uk/library/usingthelibrary/researchers/managerresearchdata.aspx> [Accessed 04/05/2015].
- UNKNOWN (30/11/1877) Photo-Collotype Pictures in Colour. *Photographic News*. XXI .
- UNKNOWN (30/09/1892) Photo-Mechanical Work. *British Journal of Photography*. XXXIX .
- UNKNOWN (2936) Reviews - Die Photoplastik. *The Photographic Journal*. 62 (August), pp.410-411.
- UNKNOWN (29/04/1898) Extract - The International Photographic Exhibition, Crystal Palace, April 25 - May 14. Sections III & IV, Apparatus & Material & Photo-Mechanical. *British Journal of Photography*. XLV .
- UNKNOWN (29/04/1870) Extract - An Indian Photographer on the Continent; The Photoype Process of MM. Tessié Du Motay and Maréchal. *British Journal of Photography*. XVII .
- UNKNOWN (28/12/1883) Some Suggestions as to the Future of Photo-Mechanical Printing Methods. *Photographic News*. XXVII .

- UNKNOWN (28/10/1870) On Alberttype and Relief Printing. *British Journal of Photography*. XVII .
- UNKNOWN (28/05/1880) Mr. Woodbury's New Process: Hints on Making Reliefs. *British Journal of Photography*. XXVII .
- UNKNOWN (25/08/1865) Printing Photographs from Metal Plates. *British Journal of Photography*. XII .
- UNKNOWN (25/07/1884) Printing Photographs By Machinery. *Photographic News*. XXVIII .
- UNKNOWN (25/04/1884) The Effect of Heat on Bichromated Gelatine while in a Fluid Condition. *British Journal of Photography*. XXXI .
- UNKNOWN (25/03/1887) Printing Collotypes at the Machine: A Visit to Waterlow & Sons, Limited. Second Article. *Photographic News*. XXXI .
- UNKNOWN (25/01/1895) Photo-Mechanical Exhibition at New York. *Photographic News*. XXXIX .
- UNKNOWN (24/12/1891) Photo-Mechanical Printing in Colours. *British Journal of Photography*. XXXVIII .
- UNKNOWN (24/08/1877) Collotype Printing. *Photographic News*. XXI .
- UNKNOWN (24/07/1885) Some Easy Ways of Making Grain Plates or Surfaces for Photo-Mechanical Processes. *Photographic News*. XXIX .
- UNKNOWN (23/12/1870) M. Grasshoff on the Albert and Woodbury Processes. *Photographic News*. XIV .
- UNKNOWN (23/07/1880) Gelatino-Bromide Negatives for Photo-Mechanical Printing. *Photographic News*. XXIV .
- UNKNOWN (23/04/1875) Recent Advances in Photographic Science. *British Journal of Photography*. XXII .
- UNKNOWN (21/05/1880) Mr. Woodbury' New Method of Photoglyptic Printing. *British Journal of Photography*. XXVII .
- UNKNOWN (21/05/1880) Mr. Woodbury's New Proces. . XXVII .
- UNKNOWN (21/03/1884) The Woodbury Process: Third Article. *Photographic News*. XXVIII .
- UNKNOWN (20/10/1865) The New Printing Process - A Day With Mr. Woodbury. *British Journal of Photography*. XII .
- UNKNOWN (1996) Groups & Regions - Victorian Chapter Australia. *The Photographic Journal*. 136 (November), pp.476.

- UNKNOWN (1996) News of Members - Alan Elliott. *The Photographic Journal*. 136 (November), pp.495.
- UNKNOWN (1986) Walter Bently Woodbury - Amendium. *The Photographic Journal*. 126 (January), pp.40.
- UNKNOWN (1985) Walter Bently Woodbury - A Monogram. *The Photographic Journal*. 125 (December), pp.551-554.
- UNKNOWN (1930) Proposed Memorial to the Memory of the Late Sir Joseph Wilson Swan FRS. DSC Progress Medalist of The Royal Photographic Society of Great Britain. *The Photographic Journal*. 70 (December), pp.538-539.
- UNKNOWN (1907) Ordinary Meeting. *The Photographic Journal*. 47 (December), pp.401-409.
- UNKNOWN (1906) Obituary - The Late Leon Vidal. *The Photographic Journal*. 46 (October), pp.316-317.
- UNKNOWN (19/11/1875) Proceedings of Societies - South London Technical Exhibition. *Photographic News*. XIX .
- UNKNOWN (1899) Acrograph Engraving Machine. *The Photographic Journal*. 39 (May 31), pp.249-251.
- UNKNOWN. (1894) Art and Science. *The Wrexham Advertiser*. Saturday 6 January , 7.
- UNKNOWN (1894) Untitled. *The Photographic Journal*. 35 (October 22), pp.27.
- UNKNOWN (1893) (Untitled) Photoplastography. *The Photographic Art Journal*. 33 (April 26), pp.197-203.
- UNKNOWN (1891) Ghent - (Details of School). *The Photographic Journal*. 32 (November 27), pp.35.
- UNKNOWN (1888) Tuesday, August 28th, 1888. J.Traill, Taylor, Member of Council, in the Chair. *The Photographic Journal*. 29 (November 30), pp.19-20.
- UNKNOWN (1885) Notes - Historical Collection by the Photographical Society of Great Britain at the International Inventions Exhibition. *The Photographic Journal*. 25 (June 26), pp.186-170.
- UNKNOWN. (1885) Poisoning by an overdose of laudanum. *Whitstable Times and Herne Bay Herald*. , 5.
- UNKNOWN (1885) WB Woodbury Fund. *The Photographic Journal*. 25 (Vol IX) (April 24), pp.126.
- UNKNOWN (1883) Treasurers Report 1882. *The Photographic Journal*. 23 (February 23), pp.181.

- UNKNOWN (1883) The Yearbook of Photography and Photographic News Almanac for 1883 . . pp.87.
- UNKNOWN (1875) Photography in Permanent Pigments with Recent Improvements in Autotype Transfer. The Photographic Journal. 16 (April 16), pp.113-117.
- UNKNOWN (1875) Report of the Council. The Photographic Journal. 16 (February 16), pp.97-98.
- UNKNOWN (1874) The Electric Light in Photography. The Photographic Journal. 16 (April 21), pp.54.
- UNKNOWN (1874) Reviews. The Photographic Journal. 16 (February 17), pp.35.
- UNKNOWN (1874) To Duplicate Negatives by the Wet Process. The Photographic Journal. 16 (April 21), pp.54.
- UNKNOWN (1872) Photography in the Printing Press. The Photographic Journal. 15 (January 15), pp.108-113.
- UNKNOWN (1870) Report of the Council. The Photographic Journal. 14 (February 14), pp.199-202.
- UNKNOWN (1869) Exhibition Notices: Groningen. The Photographic Journal. 14 (August 16), pp.93.
- UNKNOWN (1869) Miscellaneous. The Photographic Journal. 14 (September 15), pp.127.
- UNKNOWN (1869) Miscellansous: The Woodburytype Company. The Photographic Journal. 13 (January 16), pp.218.
- UNKNOWN (1869) The Permanence of Carbon Prints. The Photographic Journal. 14 (October 15), pp.130.
- UNKNOWN (1869) Prize Competition in Carbon Photography. The Photographic Journal. 14 (August 16), pp.91.
- UNKNOWN (1869) Report of Council. The Photographic Journal. 13 (February 16), pp.224.
- UNKNOWN (1868) Modified Carbon Tissue. The Photographic Journal. 13 (March 16), pp.17.
- UNKNOWN (1868) Report of the Council. The Photographic Journal. 12 (February 17), pp.184.
- UNKNOWN (1867) Report of the Commission of the French Photographic Society for Awarding the Prize of 8000 Francs by the Duc De Luynes for Printing Photographs in Ink. The Photographic Journal. 12 (July 16), pp.64-78.
- UNKNOWN (1867) Report of the commission of the French Photographic Society of awarding the Prize of 8000 francs founded by the Duc de Luynes for Printing

- Photographs in Ink. *Photographic Journal*. (July), pp.64-68-76.
- UNKNOWN (1867) Swan's Carbon Process. *The Photographic Journal*. 12 (July 16), pp.77.
- UNKNOWN (1866) The Carbon Process in France. *The Photographic Journal*. 11 (October 15), pp.134.
- UNKNOWN (1866) Improvement in Photo-Relief Printing. *The Photographic Journal*. 11 (August 15), pp.102.
- UNKNOWN (1866) Review. *Photography: Its History and Applications*. *The Photographic Journal*. 11 (October 15), pp.129-134.
- UNKNOWN (1865) New Method of Photo-Relievo Printing. *The Photographic Journal*. 10 (September 15), pp.150-153.
- UNKNOWN (1865) North London Photographic Association. *The Photographic Journal*. 10 (November 16), pp.188.
- UNKNOWN (1865) North-Eastern London Exhibition. Report of the Jurors of the Photographic Department. *The Photographic Journal*. 10 (September 15), pp.148-149.
- UNKNOWN (1865) Photographic Society. *The Photographic Journal*. 10 (December 15), pp.201-202.
- UNKNOWN (1864) Explosion of Gun-Cotton. *The Photographic Journal*. (July 15), pp.82.
- UNKNOWN (18/07/1879) Photo-Mechanical Printing for Trade Purposes. *British Journal of Photography*. XXVI .
- UNKNOWN (17/07/1885) Photo-Mechanical Processes of Ilustration. *British Journal of Photography*. XXXII .
- UNKNOWN (17/03/1899) As many of our readers may not be acquainted with the variety of gelatines.... *British Journal of Photography*. XLVI .
- UNKNOWN (16/11/1883) The Woodbury Process: Second Article. *Photographic News*. XXVII .
- UNKNOWN (16/03/1888) The Camera Club Conference - Mr. G.S. Waterlow's Paper. *Amateur Photographer*. VII .
- UNKNOWN (15/12/1865) The Discover of the Action of Light on Gelatine. *The Photographic Journal*.
- UNKNOWN (15/12/1865) Mr. Woodbury's Photo-Relievo Process. *The Photographic Journal*.
- UNKNOWN (15/01/1874) The Correlation of Photography, Lithography, and Typography: The Woiodburytype Process. *The Lithographer*.

- UNKNOWN (14/09/1883) The Woodbury Process: First Article. Photographic News. XXVII .
- UNKNOWN (13/04/1893) Extract - Messrs. Waterlow & Sons' Photo-Mechanical Printing Works. British & Colonial Printer & Stationer. XXXI .
- UNKNOWN (12/07/1889) Photographs in Printers' Ink. Amateur Photographer. X .
- UNKNOWN (11/11/1870) On Heliotype as a Means of Reproducing Works of Art (Part 1). Photographic News. XIV .
- UNKNOWN (11/10/1872) Heliotype Printing at Chatham. Photographic News. XVI .
- UNKNOWN (11/07/1890) So much interest is now being.... Amateur Photographer. XII .
- UNKNOWN (11/03/1870) New Photo-Engraving Process. Photographic News. XIV .
- UNKNOWN (10/04/1884) The Woodbury Process: Fifth Article. Photographic News. XXVIII .
- UNKNOWN (10/03/1893) How Businesses May be Revived. British Journal of Photography. XL .
- UNKNOWN (09/05/1879) Photo-Collographic Printing - The Artotype Process. Photographic News. XXIII .
- UNKNOWN (09/01/1885) Photo-Mechanical Printing for Amateurs. British Journal of Photography. XXXII .
- UNKNOWN (08/10/1897) Historical Photographs in the Photographic Section of the Imperial Victorian Exhibition at the Crystal Palace (V). British Journal of Photography. XLIV .
- UNKNOWN (06/08/1886) Extract - Photography in Belgium. British Journal of Photography. XXXIII .
- UNKNOWN (05/02/1869) Herr Albert's New Mechanical Printing Process. Photographic News. XIII .
- UNKNOWN (05/01/1894) Amateur Photographer Foreword - Photo-Mechanical Processes. Amateur Photographer. XIX .
- UNKNOWN (04/10/1867) Contemporary Press - Remarks on the Photographs in the French Exhibition. British Journal of Photography. XIV .
- UNKNOWN (04/04/1884) The Woodbury Process: Fourth Article. Photographic News. XXVIII .
- UNKNOWN (04/01/1878) Recent Patents - No.1 - Photographic Plates for Printing. British Journal of Photography. XXV .

- UNKNOWN (03/06/1887) Fifty Years Development of the Graphic Arts. Amateur Photographer. V .
- UNKNOWN (03/03/1871) Correspondence - The age of discovery in photography is almost, if not altogether, passed away.... British Journal of Photography. XVIII .
- UNKNOWN (02/09/1870) Mr. Edwards' Photo-Collographic Process. Photographic News. XIV .
- UNKNOWN (02/05/1884) The Woodbury Process: The Sixth Article. British Journal of Photography. XXVIII .
- UNKNOWN (01/06/1870) Editorial. The Photographic Art Journal.
- UNKNOWN (01/01/1875) Extract - The Past Year. British Journal of Photography. XXII .
- VAN Pottelsberghe de la Potterie, Bruno (2010) Patent fixes for Europe. Nature [online]. 467 (7314), pp.395-395.
- VERIKAS, A., Lundström, J., Bacauskiene, M. and Gelzinis, A. (2011) Advances in computational intelligence-based print quality assessment and control in offset colour printing. Expert Systems with Applications. 38 pp.13441-13447.
- VIDAL, L. (20/06/1879) French Correspondence - Phototypie at the Meeting of the Photographic Society of France. Photographic News. XXIII .
- VIDAL, L. (1891) Photographic Methods of Obtaining Polychromatic Impressions. The Photographic Journal. 31 (May 22), pp.146-153.
- VIDAL, L. (11/07/1890) Photography in France - Collographic Process by M. Balagny. Photographic News. XXXIV .
- VIMEO Vimeo. Available from: <https://vimeo.com> [Accessed 27 May 2016].
- VIRILIO, P. (1998) The Information Bomb. 2005th ed. London: Verso.
- VIRILIO, P. (1993) The Third Interval: A Critical Translation. In: Andermatt Conley, V., ed. (1993) Rethinking Technologies. Minneapolis: University of Minnesota Press, pp.3.
- VITAE (2010) Introducing the Researcher Development Framework. Vitae, Careers Research and Advisory Centre.
- VITAE What do Researchers do? Available from: <https://www.vitae.ac.uk/impact-and-evaluation/what-do-researchers-do> [Accessed 04/05/2015].
- VOGEL, D.H. (25/06/1869) The Albert Process and its Practical Value. Photographic News. XIII .
- VOGEL, D.H. (15/10/1869) German Correspondence - The Albert Prints Compared With Those by the Woodbury Processes. British Journal of Photography. XVI .
- VON Hippel, E. (2011) People Don't Need A Profit Motive To Innovate. Harvard Business

- Review [online]. 89 (11), pp.36-37.
- WALKLIN, C. (1991) *Relief Printmaking a Manual of Techniques* Colin Walklin. Crowood Press.
- WALL, E.J. (27/07/1894) *Photography in Colours (Part 2)*. *Photographic News*. XXXVIII .
- WALL, E.J. (1912) *The Dictionary of Photography and Reference Book for Amateur and Professional Photographers*. 9th ed. London: Hazell, Watson & Viney, Ltd.
- WALL, E.J. (1894) *Photography in Colours*. *The Photographic Journal*. 34 (June 26), pp.290-297.
- WALLIS, G. (1863) *The New Art of Autotypography*. *The Engineer*. (April 24), pp.229-230.
- WARNERKE, L. (1881) *A New Discovery Regarding Gelatine Emulsion*. *The Photographic Journal*. 21 (May 20), pp.122.
- WARNERKE, L. (1881) *On Sensitometers*. *The Photographic Journal*. 21 (February 18), pp.75-82.
- WARNERKE, L. (1879) *On Actinometers*. *The Photographic Journal*. 20 (December 20), pp.19-29.
- WARREN, L., ed. (2005) *Encyclopedia of Twentieth-Century Photography (Volume 1-3)*. 1st ed. USA: Routledge.
- WASTELL, W.L.F. (1922) *The Evolution of the Lantern Slide*. *The Photographic Journal*. 62 (December), pp.494-507.
- WATERHOUSE, M.J. (15/11/1878) *On Processes of Map Production by Photography (Part 2)*. *British Journal of Photography*. XXV .
- WATERHOUSE, M.J. (01/07/1892) *Early Photo-Mechanical Printing Processes*. *British Journal of Photography*. XXXIX .
- WATERHOUSE, M.J. (1880) *On a New Method of Obtaining "Grain" in Photo Engraving*. *The Photographic Journal*. 21 (November 19), pp.20-21.
- WATERLOW, G.S. (30/03/1888) *Modern Photographic Engraving and Printing (Part 2)*. *Photographic News*. XXXII .
- WATERLOW, G.S. (23/03/1888) *Modern Photographic Engraving and Printing (Part 1)*. *Photographic News*. XXXII .
- WATERLOW, P. and Geddes, J.D. (15/04/1892) *Extract - Photography and Photo-Mechanical Printing (Part 1)*. *Photographic News*. XXXVI .
- WATERLOW, P. and Geddes, J.D. (15/04/1892) *Extract - Photography and Photo-Mechanical Printing (Part 2)*. *British Journal of Photography*. XXXIX .
- WEAVER, M., ed. (1992) *Henry Fox Talbot, Selected Texts and Bibliography*. 1st ed.

Oxford, England: Clio Press.

WEBB, R. and Reed, M. (1999) *Spirit of Salts. A Working Guide to Old Photographic Processes*. London: Argentum, Aurum Press.

WEBB, R.H. and Dorey, C.K. (1990) The Pixelated Image. In: Pawley, J.B., ed. (1990) *Handbook of Biological Confocal Microscopy*. Plenum Press, pp.41-51.

WEBSTER, M.A. (2004) Adaptation and subjective image quality. *Journal of Vision* [online]. 4 (11), pp.4-4.

WEEKS, A.R. (1996) *Fundamentals of Electronic Image Processing*. 1st ed. Washington, USA: SPIE Press.

WENDE, A. v. d. (2010) Innovative Printmaking. *Art New England* [online]. 31(2), pp. 18-21.

WESTLEY, A. (2001) *Relief Printmaking* [online]. London: A. & C. Black.

ANON. (2007) [online]. Available from: <http://dx.doi.org/10.1145/1275808.1276417>.

WHAITE, T.G. (1886) Our Illustration - Market Place at Dinant. *The Photographic Journal*. 26 (Mar 26), pp.112-113.

WHALE, G. and Barfield, N. (2001) *Digital Printmaking* [online]. 1st ed. London: A. & C. Black.

WHITNEY, W.D. and Smith, B.E. (1911) *The Century Dictionary and Cyclopedia*. Revised ed. Century Company.

WILKINSON, B.G. (1887) Our Illustration - Fishing Boats - Rye Sussex. *The Photographic Journal*. 28 (December 30), pp.40-41.

WILKINSON, W.T. (29/05/1896) Process Application of the Bichromate Salts (Photography with the Bichromate Salts). *The Photographic Journal*.

WILKINSON, W.T. (1896) Affiliation of Photographic Societies. Six Lectures on "Photography with the Bichromate Salts" v) Photo-Lithography and Photozincography. *The Photographic Journal*. 36 (May 29), pp.273-277.

WILKINSON, W.T. (1896) Affiliation of Photographic Societies. Six Lectures on "Photography with the Bichromate Salts" vi) Process Application of the Bichromate Salts. *The Photographic Journal*. 36 (May 29), pp.277-281.

WILLIAMS, L.K. and McGuire, S.J. (2010) Economic creativity and innovation implementation: the entrepreneurial drivers of growth? ; Evidence from 63 countries. *Small Business Economics* [online]. 34 (4), pp.391-412.

WILLIAMS, S. (2006) Practical colour management. *Optics & Laser Technology* [online]. 38 (4-6), pp.399-404.

- WILLIS, A.G. (1921) The no light Carbo Process. *British Journal of Photography*. 68 (July 22nd), pp.434.
- WILLIS, A.G. (1921) The no light Carbo Process. *British Journal of Photography*. 68 (July 22nd), pp.434.
- WILLS, C. and WILLS, D. (1985) WALTER BENTLEY WOODBURY. *Photographic Journal*. 125 (125), pp.551-554.
- WILSON, E.L. (21/01/1870) American Correspondence - Woodburytypes. *Photographic News*. XIV .
- WILSON, E.L. (1868) *The American Carbon Manual*. Scovill Manufacturing Company.
- WILSON, E.L. (07/01/1870) Photography in America. *Photographic News*. XIV .
- WINSTANLEY, D. (24/06/1887) Photography on Colours. *British Journal of Photography*. XXIV .
- WINSTANLEY, D. (12/07/1867) The Solubility of Chromated Gelatine Salts. *British Journal of Photography*. XIV .
- WINSTANLEY, D. (03/08/1888) Photo-Mechanical Printing. *Photographic News*. XXXII .
- WISKER, G. (2001) *The Postgraduate Research Handbook: Succeed with Your MA, MPhil, EdD and PhD* [online]. Basingstoke: Palgrave.
- WOODBURY, W.B. (Feb 20 1866) Mode of Printing Photographs Anon. US Patent 52803.
- WOODBURY, W.B. (25/02/1870) Recent Patents - Photo-Relief Printing. *Photographic News*. XIV .
- WOODBURY, W.B. (24/05/1867) Recent Patents - Photo-Relief Printing by Machinery. *Photographic News*. XI .
- WOODBURY, W.B. (1880) Modified Woodbury Type Process. *The Photographic Journal*. 20 (May 21), pp.118-120.
- WOODBURY, W.B. (1875) Carbon Lantern Slides. *British Journal Photographic Almanac and Photographer's Daily Companion*.
- WOODBURY, W.B. (1874) My Experiences in Producing Negatives in Plumbago. *The Photographic Journal*. 16 (May 27), pp.63-65.
- WOODBURY, W.B. (1872) Photo-Engraving: A New Method. *British Journal Photographic Almanac and Photographer's Daily Companion*.
- WOODBURY, W.B. (1870) Improvements in Photo-Press Printing. *British Journal Photographic Almanac and Photographer's Daily Companion*.
- WOODBURY, W.B. (1869) Description of the Woodburytype, or Photo-Relief Process. *The Photographic Journal*. 14 (Mar 16), pp.4.

- WOODBURY, W.B. (1867) On a Method of Obtaining Imperishable Photographs. British Journal Photographic Almanac and Photographer's Daily Companion.
- WOODBURY, W.B. (1865) A New Photo-Relief Printing Process. The Photographic Journal. 10 (December 15), pp.202-207.
- WOODBURY, W.B. (18/08/1865) The New Photo-Relief Printing Process In Semi-Transparent Ink. Photographic News. IX .
- WOODBURY, W.B. (16/03/1869) Description of the Woodburytype, or Photo-Relief Process. The Photographic Journal.
- WOODBURY, W.B. (15/12/1865) A New Photo-Relief Printing Process. The Photographic Journal.
- WOODBURY, W.B. (10/07/1874) Recent Patents - Photo Block Printing. Photographic News. XVII .
- WOODBURY, W.B. (09/07/1869) Improvements in Photo-Press Printing. British Journal of Photography. XVI .
- WOODBURY, W.B. (04/10/1872) Mechanical Printing. British Journal of Photography. XIX
- WOODBURY, W.E. (20/08/1886) Photography in Germany - Lichtdruck (Collotype) Printing. Photographic News. XXX .
- WOODBURY, W.E. (1896) The Encyclopaedic Dictionary of Photography. The Scovill & Adams Company of New York.
- WOODBURY, W.E. (01/01/1898) Stannotype. The Encyclopaedic Dictionary of Photography.
- WOODBURY, W.B. (1880) Woodbury's New Photoglypic Process. British Journal of Photography. 27 (May 14), pp.233.
- WOODBURY, W.B. (1869) Description of the Woodburytype, or Photo-relief process. The Photographic Journal. 14 (March 16), pp.4-5.
- WOODBURY, W.B. (1866) Printing photo-relievo photographs with white margins. Photographic News. (November 9), pp.534.
- WOODBURY, W.B. (1865) Woodbury's New Printing Process. British Journal of Photography. 12 (134), .
- WOODBURY, W.B. (1864) An Improved Method of Producing Or Obtaining by the Aid of Photography Surfaces in 'Relievo' and 'Intaglio' upon Aluminous, Vitreous, Metallic, Or Other Suitable Materials Anon. .
- WOODBURY, W.B. (17/03/1865) Woodbury's New Printing Process. British Journal of Photography. XII .

- WOODBURY, W.B. (15/12/1865) Photo-Relief Printing. . XII .
- WOODBURY, W.B. (12/05/1865) Mr. Swan's Claim Versus Mr. Woodbury's. British Journal of Photography. XII .
- WOODBURY, W.B. (12/05/1865) New Patent: Complete Specification of Patent Obtained by Walter Bently Woodbury, Manchester, filed 23rd March, 1865. British Journal of Photography. XII .
- WOODBURY, W.B. (01/01/1869) How to Transfer a Negative Film. British Journal Photographic Almanac and Photographer's Daily Companion.
- WOOLFE, G. (2007) Natural Language Color Editing. Inter-Society Color Council 2008 Annual Meeting.
- WORDPRESS Wordpress. Available from: <https://wordpress.org> [Accessed 04/05/2015].
- WORTLEY, Stuart H. Lieut. Colonel (25/08/1871) Extract - Official Report of Photography in the International Exhibition of 1871. British Journal of Photography. XVIII .
- XIAO, F., Farrellb, J.E., DiCarloc, J.M. and Wandella, B.A. (2003) Preferred Color Spaces for White Balancing. Imaging. 5017 .
- YANG, Y., Ming, J. and Yu, N. (2012) Color Image Quality Assessment Based on CIEDE2000. Advances in Multimedia. 2012 (2012), .
- YED Yed. Available from: www.yworks.com/en/products/yfiles/yed/ [Accessed 04/05/2015].
- YOUNG, P. (2011) Printing In. Applied Arts Magazine.
- YOUNG, P. (2011) Printing in. Applied Arts [online]. 26(3), pp. P22-P25.
- ZHAI, Y., ADOS, D.A. and LAGOY, J.L. (2014) Additive Manufacturing: Making Imagination the Major Limitation. The Journal of the Minerals, Metals & Materials Society. 66 (5), pp.808-816.
- ZILVINAS Jancoras (2011) Free Digital Works: From Free Software To Creative Society. Santalka : Filosofija, Komunikacija [online]. 19 (2), pp.39.